



NUCOR CORPORATION – VULCRAFT/VERCO GROUP

VULCRAFT GROUP

7205 Gault Avenue North
Fort Payne, Alabama 35967
(256) 845-2460

6610 County Road 60
St. Joe, Indiana 46785
(260) 337-1800

1601 Omaha Avenue
Norfolk, Nebraska 68701
(402) 644-8500

621 Main Street
Chemung, New York 14825
(607) 529-9000

1501 West Darlington Street
Florence, South Carolina 29501
(843) 662-0381

175 County Road 2345
Grapeland, Texas 75844
(936) 687-4665

www.vulcraft.com

STEEL DECK PANELS

CSI DIVISION: 05 00 00 – METALS

CSI SECTION: 05 31 00 – STEEL DECK

05 31 13 – STEEL FLOOR DECKING

05 31 23 – STEEL ROOF DECKING

1.0 RECOGNITION

Steel deck panels recognized in this report have been evaluated for use as a component of horizontal or sloped floor and roof systems supporting out of plane loads, in-plane diaphragm shears, and in-plane axial loads. Physical characteristics and structural performance properties comply with the intent of the provisions of the following codes and regulations:

- 2018, 2015 and 2012 International Building Code® (IBC)
- 2018, 2015 and 2012 International Residential Code® (IRC)

2.0 LIMITATIONS

Use of the steel deck panels recognized in this report is subject to the following limitations:

2.1 Sound Transmission Performance: Acoustic performance is beyond the scope of this report.

2.2 Fire-Resistance Ratings: Fire-resistance performance is beyond the scope of this report.

2.3 The steel deck panels shall be installed in accordance with the applicable code, the manufacturer’s published installation instructions, and this report. Where there is a conflict, the most restrictive requirements shall govern.

2.4 Calculations and details demonstrating that the loads applied to the steel deck panels comply with this reports shall be submitted to the building official for approval. Calculations and drawings shall be prepared, signed, and sealed by a registered design professional where required by the statutes of the jurisdiction in which the project is to be constructed.

2.5 The steel panels recognized in this report are produced by Vulcraft in Fort Payne, Alabama, St. Joe, Indiana, Norfolk, Nebraska, Chemung, New York, Florence, South Carolina and Grapeland, Texas.

2.6 The Sammys X-Press Anchors recognized in this report are produced in Elk Grove Village, Illinois.

3.0 PRODUCT USE

3.1 General:

Steel deck panels may be designed to resist out-of-plane loads, in-plane diaphragm shear loads, and axial loads.

3.2 Design:

3.2.1 Out-of-Plane Strength and Deflection: Out-of-plane strength of steel deck panels shall be determined using engineering mechanics and deck panel properties presented in this report. Steel deck panels shall not be used under conditions subject to loads that are predominately cyclic in nature unless a registered design professional submits substantiating calculations to the building official in accordance with AISI S100-16 Chapter M under the 2018 IBC and IRC (AISI S100-12 Chapter G under the 2012 and 2015 IBC and IRC).

Deflections resulting from out-of-plane loads shall comply with Section 1604.3 of the IBC.





3.2.2 Composite Steel Deck-Slabs: Composite steel deck-slab out-of-plane load strength (superimposed loads) shall be determined in accordance with ANSI/SDI C using properties and composite coefficients in this report. In accordance with ACI 318-14 26.4.1.4.1(c) or ACI 318-11 3.6.4, calcium chloride or admixtures containing chloride from sources other than impurities in admixture ingredients are prohibited from use in concrete cast against stay-in-place galvanized steel deck. Use of concrete-filled composite steel deck slabs to support loads that are predominantly vibratory is beyond the scope of this report.

3.2.3 Reactions: The strength of steel deck panels to resist reaction loads at supports and locations of concentrated loads shall be determined based on the either web crippling strength or web shear strength. Web crippling strength shall be determined in accordance with AISI S100-16 Section G5 under the 2018 IBC and IRC (AISI S100-12 Section C3.4 under the 2012 and 2015 IBC and IRC) and the properties in this report. Deck panel web shear strength of deck panel webs shall be determined in accordance with AISI S100-16 Section G2.1 under the 2018 IBC and IRC (AISI S100-12 Appendix 1 Section 1.2.2.2.1 under the 2012 and 2015 IBC and IRC) and the properties in this report. The strength of web-perforated deck panels shall be determined in accordance with the equations in this report.

3.2.4 In-Plane (Diaphragm) Shear Strength and Stiffness: The in-plane shear strength of steel roof deck, non-composite steel deck, or composite steel deck-slabs shall be determined in accordance with AISI S310-16 including the modifications and properties in this report. For steel deck-slabs it is permitted to determine diaphragm shear strength and shear stiffness with the provisions of this report in lieu of AISI S310-16. The steel deck-slab provisions in this report were developed based on full scale reverse cyclic testing.

When steel deck panels are used as the stressed skin shear carrying element of a horizontal or sloped diaphragm as defined in Section 1602 of the IBC, the diaphragm length and width shall be limited by one of the following: engineering mechanics, applied loads, shear capacity of the diaphragm, diaphragm shear deflection limited by the requirements of ASCE/SEI 7 in Sections 12.8.6 entitled, "Story Drift Determination", or Section 12.12 entitled, "Drift and Deformation". Shear deflection shall be based on the shear stiffness for the steel deck diaphragm and equations of mechanics.

The use of steel deck diaphragms for vertical diaphragms (shear walls) is beyond the scope of this report.

3.2.5 Axial Strength: The axial strength or combined axial and bending strength of steel deck panels shall be determined in accordance with AISI S100 using the properties in this report.

3.2.6 Wall Bracing: The design for anchorage of structural walls and transfer of anchorage forces into the diaphragm shall be in accordance with Section 12.11.2 of ASCE/SEI 7, subject to the following limitations:

1. Transfer of anchorage forces into diaphragm shall be in the direction parallel to the flutes (ribs) of the steel deck.
2. When acting as the continuous ties or struts between diaphragm chords, anchorage forces shall be distributed into the diaphragm in the direction parallel to the flutes (ribs) of the steel deck.
3. Combined axial load and bending shall be considered in accordance with Section H1 of AISI S100-16 under the 2018 IBC and IRC (Section H1 of AISI S100-12 under the 2015 and 2012 IBC and IRC) to determine the strength of steel deck (without concrete fill) used to resist wall anchorage forces or to resist continuous tie forces parallel to the flutes (ribs).
4. Power-actuated fasteners, self-drilling screws, or welded connections described in this report are permitted to provide positive means of attachment to satisfy the connection requirements in ASCE/SEI 7 Section 12.11.2.2.1.

3.2.7 Partial Panels, Openings, Holes or Penetrations through Steel Deck: The registered design professional may submit design calculations and details to the building official for approval based on the principles of engineering mechanics for partial panels, openings, holes or penetrations. For lateral force resisting systems, the calculations shall consider the effects of partial panels, openings, holes, or penetrations on the overall strength and stiffness of the diaphragm.

3.2.8 Supporting Member Materials: Supporting members shall comply with the requirements of AISI S310-16.

3.2.9 Bekaert Dramix® Steel Fiber: Bekeart Dramix steel fibers shall comply with UES Evaluation Report ER-465 and the provisions of this report.

3.2.10 Connections:

3.2.10.1 Self-Drilling Screws: Self-drilling screws may be used to attach steel deck panels to supporting members and to attach the sidelaps of steel deck panels to each other in accordance with AISI S100 and AISI S310 unless described in this report. The screws shall be manufactured in accordance with SAE J78 and shall be compliant with ASTM C1513.



3.2.10.2 Proprietary Fasteners: Proprietary screws and power actuated fasteners (PAF's) may be used to attach steel deck panels to supporting members in accordance with this report. The fasteners shall be designed to attach steel deck panels to supporting members and shall be described in a current evaluation report issued by an approved and accredited evaluation service agency.

3.2.10.3 Welds: Welds may be used to attach steel deck panels to supporting members and to attach the sidelaps of steel deck panels to each other in accordance with AISI S100 and AISI S310-16. The minimum tensile strength of the weld filler shall be designated as a minimum of 60 ksi (413.7 MPa) and comply with the appropriate AWS standard.

3.2.10.4 Non-Piercing Button Punch: Non-piercing button punch may be used to attach the sidelaps of steel deck panels to each other in accordance with AISI S310-16.

3.2.10.5 PunchLok® II System: The PunchLok II system consists of PunchLok deck described in this report connected at sidelaps with the Vulcraft/Vercos Group proprietary connection. Acoustical and cellular versions of the listed deck sections may also be used. The proprietary connection is referred to as the "Vulcraft/Vercos Sidelap Connection 2" (VSC2), and is an interlocking connection between the male and female lips of the appropriate deck. A VSC2 connection is made in either direction relative to the female lip. A VSC2 connection is made when the sidelap material has been sheared and offset so the sheared surface of the steel deck panel male lip is visible. This punched portion measures 0.45 inch (11.4 mm) – 0.70 inch (17.8 mm) nominal width by 0.30 inch (7.6 mm) nominal height. The PunchLok II system shall be installed in accordance with Vulcraft/Vercos Group instructions. The resulting VSC2 connection is illustrated on page 13 of this report.

3.2.10.6 Shearflex Standoff Screws: Shearflex Standoff Screws may be used as shear connectors between concrete-filled steel deck and steel support members in accordance with this report. Shearflex Standoff Screws shall be installed in accordance with UES Evaluation Report ER-366.

3.3 Installation:

Steel deck panel erection sequence and installation method is the responsibility of the contractor(s) performing installation of the steel deck panels. Installation shall be in accordance with this report, ANSI/SDI RD, ANSI/SDI NC and ANSI/SDI C and all welds shall comply with AWS D1.3. Where conflicts occur, the more restrictive shall govern. Additional installation information is available in the Steel Deck Institute (SDI MOC) Manual of Construction with Steel Deck and manufacturer's recommendations. Mechanical fasteners shall be installed in accordance with the manufacturer's current evaluation report issued by an approved and accredited evaluation service agency. Quality control during installation shall comply with ANSI/SDI QA/QC.

3.4 Inspections:

3.4.1 General: Special inspection is required in accordance with IBC Chapter 17. Quality control and quality assurance for deck installation shall comply with ANSI/SDI QA/QC, where the special inspector duties are as set forth for the quality assurance inspector (QAI).

3.4.2 Jobsite Welding: Periodic special inspection for welding shall be in accordance with IBC Section 1705.2.2. Prior to proceeding, the welder shall demonstrate the ability to produce the prescribed weld to the special inspector's satisfaction. The inspector's duties include verification of materials, weld preparation, welding procedures, and welding processes.

3.4.3 Concrete: Continuous and periodic special inspection for concrete and concrete reinforcement shall be in accordance with Section 1705.3 of the IBC. The inspector's duties include sampling and testing, and verification of concrete mixes, reinforcement types and placement, and concrete placement.

3.4.4 Seismic-Force-Resisting Systems and Wind-Force-Resisting Systems: Where the steel deck is used in a seismic-force-resisting system in structures assigned to Seismic Design Category C, D, E or F, periodic special inspections for weld, screw and power-actuated fastener connections are required in accordance with 2018 and 2015 IBC Section 1705.12.3 (2012 IBC Section 1705.11.3)

Where the steel deck is used in a wind-force-resisting system in structures located in areas described in 2018 and 2015 IBC Section 1705.11 (2012 IBC Section 1705.10), periodic special inspections for weld, screw and power-actuated fastener connections are required in accordance with 2018 and 2015 IBC Section 1705.11.3 (2012 IBC Section 1705.10.3).



4.0 PRODUCT DESCRIPTION

4.1 Steel Deck Panels: The steel deck panels described in this report are cold-formed from steel sheets into panels with fluted sections having galvanized, phosphatized/painted, painted/painted, or mill finishes. Panel characteristics including profile designation, sidelap type, applicable sidelap fasteners and perforation for fluted profiles are described in the tables and figures that accompany this report.

The galvanized deck panels are formed from either ASTM A653 or A1063 steel, with a minimum G30 galvanized coating designation. The phosphatized/painted, painted/painted, or mill finished steel deck panels are formed from either ASTM A1008 or A1039 steel. Phosphatized/painted deck panels have a phosphatized (uncoated) top surface and primer painted bottom surface.

Painted/painted deck panels have primer painted top and bottom surfaces. Mill-finished deck panels have no coating on either top or bottom surfaces.

Vulcraft® and PunchLok® are registered trademarks of Nucor Corporation or its affiliates.

4.2 Concrete: Concrete shall be either lightweight concrete or normal weight concrete and comply with Chapter 19 of the IBC. In accordance with ACI 318-14 26.4.1.4.1(c) or ACI 318-11 3.6.4, calcium chloride or admixtures containing chloride from sources other than impurities in admixture ingredients are prohibited from use in concrete cast against stay-in-place galvanized steel deck or embedded items. The minimum compressive strength shall be as indicated in the tables and figures of this report.

5.0 IDENTIFICATION

Each bundle of deck panels is identified with a visible label. The label includes the manufacturer's name (Vulcraft), production location (Ft. Payne, Alabama; St. Joe, Indiana; Norfolk, Nebraska; Chemung, New York; Florence, South Carolina; Grapeland, Texas), deck type, steel gage, one of the IAPMO ES Marks of Conformity noted below, and evaluation report number (ER-0652).

6.0 SUBSTANTIATING DATA

Data in accordance with the IAPMO Uniform Evaluation Service Evaluation Criteria EC007-2020, Evaluation Criteria for Steel Composite, Non-composite, and Roof Deck Construction. Test reports are from laboratories in compliance with ISO/IEC 17025.

7.0 STATEMENT OF RECOGNITION

This evaluation report describes the results of research completed by IAPMO Uniform Evaluation Service on Vulcraft Group Steel Floor Decking and Steel Roof Decking. Products are manufactured at locations noted in Section 2.5 and 2.6 of this report under a quality control program with periodic inspection under the supervision of IAPMO UES.

Brian Gerber, P.E., S.E.
Vice President, Technical Operations
Uniform Evaluation Service

Richard Beck, PE, CBO, MCP
Vice President, Uniform Evaluation Service

GP Russ Chaney
CEO, The IAPMO Group

For additional information about this evaluation report please visit www.uniform-es.org or email at info@uniform-es.org

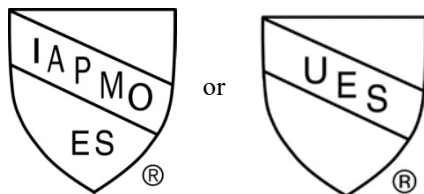

IAPMO UES ER-0652



TABLE OF CONTENTS

Subject	Page
Profile Characteristics	5
Sidelap Types	6
Embossed Profiles	6
Perforated Profiles	7
Composite Steel Deck-Slab Coefficient	8
Support Connection Tension Flexibility	8
Support Connection Shear Rupture Strength	8
Cellular Deck Intermittent Fasteners	8
Diaphragm Shear Strength and Stiffness	9
Diaphragm Shear Strength and Stiffness of Structural Concrete Filled Deck-Slabs	10
Structural Concrete Filled Steel Deck-Slab Shear Transfer to Chords and Collectors	10
Steel Roof Deck Diaphragm Length for Differential Thermal Effects	11
Proprietary Fasteners	12-14
Proprietary Support Fastener Properties	15
Maximum Diaphragm Shear Between Openings Reinforced with Cold-Formed Steel Curbs	16
1.5PLB-36 or 1.5BI-36 Roof Deck Spans for Concentrated Loads	17
ITW Buildex SAMMYS X-Press Connection	18
Definitions of Section Property Symbols	19-21
Panel Properties	22-49
1.5B-36, 1.5B-30, 1.5VL-36, 1.5BI-36, 1.5PLB-36, 1.5VLI-36, 1.5PLVLI-36	22-23
3NL-32, 3NI-32, 3PLN-32	24-25
3N-24, 3NI-24	26-27
2VLI-36, 2PLVLI-36, 2VLJ-36, 2C-36	28
3VLI-36, 3PLVLI-36, 3VLJ-36, 3C-36	29
1.5BA-36, 1.5BA-30, 1.5BIA-36, 1.5PLBA-36	30
3NLA-32, 3NIA-32, 3PLNA-32	31
3NA-24, 3NIA-24	32
1.5C-36, 1.5C-30, 1.5VLR-36	33
1.3C-32	34
1.0C-36	35
1.0C-33	36
1.0C-32	37
0.6C-35, 0.6C-30	38
0.6C-36	39
1.5BP-36, 1.5PLBP-36, 1.5BP-24, 1.5PLBP-24, 1.5VLP-36, 1.5PLVLP-36, 1.5VLP-24, 1.5PLVLP-24	40
3NP-32, 3PLNP-32	41
3NP-24, 3PLNP-24	42
2VLP-36, 2PLVLP-36	43
3VLP-36, 3PLVLP-36	44
1.5BPA-36, 1.5PLBPA-36, 1.5BPA-24, 1.5PLBPA-24, 1.5VLPA-36, 1.5PLVLPA-36, 1.5VLPA-24, 1.5PLVLPA-24	45
3NPA-32, 3PLNPA-32	46
3NPA-24, 3PLNPA-24	47
2VLPA-36, 2PLVLPA-36	48
3VLPA-36, 3PLVLPA-36	49



PROFILE CHARACTERISTICS									
Profile Designation(s)	Sidelap Type		Sidelap Fastener			Embossed	Cellular	Acoustic	
	Inter-locking	Nestable	VSC2	Screws	Other ¹			Web Perforated	Perforated Bottom Pan
1.5PLB-36, 3PLN-32	✓		✓						
1.5BI-36, 3NI-32, 3NI-24, 2C-36, 3C-36	✓				✓				
1.5B-30, 1.5B-36, 3NL-32, 3N-24, 1.3C-32, 0.6C-35, 0.6C-30, 0.6C-36, 1.0C-32, 1.0C-33, 1.0C-36, 1.5C-30, 1.5C-36		✓		✓	✓				
1.5PLVLI-36, 2PLVLI-36, 3PLVLI-36	✓		✓			✓			
1.5VLI-36, 2VLI-36, 3VLI-36	✓				✓	✓			
2VLJ-36, 3VLJ-36	✓			✓		✓			
1.5VL-36, 1.5VLR-36		✓		✓	✓	✓			
1.5PLBA-36, 3PLNA-32	✓		✓					✓	
1.5BIA-36, 3NIA-32, 3NIA-24	✓				✓			✓	
1.5BA-36, 3NLA-32, 3NA-24		✓		✓				✓	
1.5PLBP-36, 1.5PLBP-24, 3PLNP-32, 3PLNP-24	✓		✓				✓		
1.5BP-36, 1.5BP-24, 3NP-32, 3NP-24	✓				✓		✓		
1.5PLVLP-36, 1.5PLVLP-24, 2PLVLP-36, 3PLVLP-36	✓		✓			✓	✓		
1.5VLP-36, 1.5VLP-24, 2VLP-36, 3VLP-36	✓				✓	✓	✓		
1.5PLBPA-36, 1.5PLBPA-24, 3PLNPA-32, 3PLNPA-24	✓		✓				✓		✓
1.5BPA-36, 1.5BPA-24, 3NPA-32, 3NPA-24	✓				✓		✓		✓
1.5PLVLP-36, 1.5PLVLP-24, 2PLVLP-36, 3PLVLP-36	✓		✓			✓	✓		✓
1.5VLP-36, 1.5VLP-24, 2VLP-36, 3VLP-36	✓				✓	✓	✓		✓

1. Other = Top arc seam sidelap welds or non-piercing button punch sidelap connections for interlocking profiles and arc spot or fillet welds for nestable profiles.

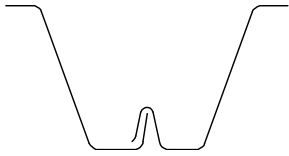
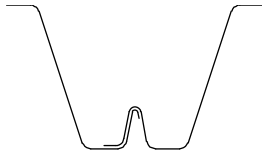
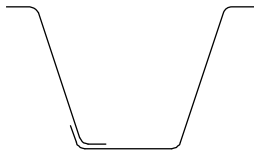
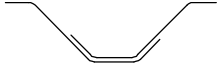

SIDELAP TYPES			
Standard Interlocking (PunchLok II, Other)	J Style Interlocking (Screwed Sidelap, Other)	Nestable (Screwed Sidelap)	Nestable (C Deck)
			

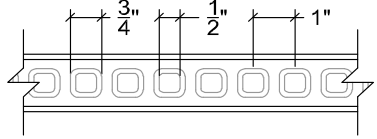
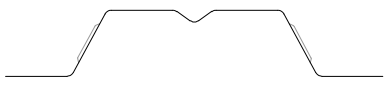
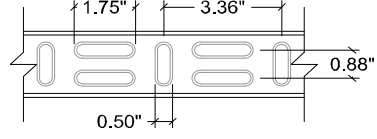
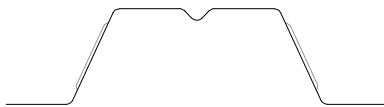
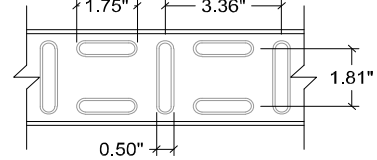
EMBOSSED PROFILES		
Profiles	End View	Side View
1.5PLVLI-36, 1.5VLI-36, 1.5VL-36, 1.5VLP-36, 1.5PLVLP-36 1.5VLP-24, 1.5PLVLP-24, 1.5VLPA-36, 1.5PLVLPA-36 1.5VLPA-24, 1.5PLVLPA-24		
2PLVLI-36, 2VLI-36, 2VLJ-36, 2VL-36, 2VLP-36, 2PLVLP-36, 2VLPA-36, 2PLVLPA-36		
3PLVLI-36, 3VLI-36, 3VLJ-36, 3VL-36, 3VLP-36, 3PLVLP-36, 3VLPA-36, 3PLVLPA-36		



PERFORATED PROFILES

Perforated Web Reduction Factor

The perforated web reduction factor, q_s , is calculated as follows:

$$q_s = 1 - (1 - k) \left(\frac{W_p}{h_w} \right) \quad [\text{Eq. W-1}]$$

$$p_o = 0.9069 \left(\frac{d_p^2}{c_p^2} \right) \quad [\text{Eq. W-2}]$$

$$\begin{aligned} k &= 1 - 2.175p_o \text{ for } p_o < 0.20 \\ k &= 0.9 + p_o^2 - 1.875p_o \text{ for } 0.20 \leq p_o \leq 0.58 \end{aligned} \quad [\text{Eq. W-3}]$$

Where:

q_s = Perforated web reduction factor

k = Ratio of stiffness

W_p = Width of perforated band in web, in.

h_w = Flat dimension of web measured in plane of web, in.

p_o = Percentage of open area

d_p = Diameter of perforation hole, in.

c_p = Perforation hole center-to-center spacing, in.

Shear Strength of Profiles with Perforated Webs

The vertical shear strength for profiles with perforated webs shall be calculated as follows:

$$V_{np} = q_s n_w V_n \sin\theta \quad [\text{Eq. W-4}]$$

Where:

V_{np} = Vertical shear strength of profile with perforated web, kip/ft

n_w = Number of webs per foot

V_n = The nominal shear strength of solid web calculated in accordance with AISI S100-16 Sec. G2.1, kips

θ = Angle between plane of web and plane of bearing surface, deg

Web-Crippling Strength of Profiles with Perforated Webs

The web-crippling strength of a perforated web shall be calculated in accordance with AISI S100-16 Sec. G5 with the following modifications:

$$P_n = Ct^2 F_y \cdot \sin\theta \cdot \left(1 - C_R \sqrt{\frac{R}{t}} \right) \left(1 + C_N \sqrt{\frac{N}{t}} \right) \left(1 - C_h \sqrt{\frac{h_w}{q_s t}} \right) \quad [\text{AISI S100-16 Eq. G5-1}]$$

(Modified)

All variables are as defined in AISI S100-16 Section G5



COMPOSITE STEEL DECK-SLAB COEFFICIENT, K

The flexural strength for composite steel floor deck slabs utilizing steel deck panels be designed in accordance with ANSI/SDI C-2017 Section A2.2 where:

$$K = 2.03 - 1.31 \left(\frac{h_c}{h - y_b} \right) \geq K_{\min} \quad [\text{Eq. K-1}]$$

Where:

h_c = Thickness of concrete cover (in.)

h = Total thickness of deck slab (in.)

y_b = Distance from extreme bottom fiber to neutral axis of gross section (in.)

K_{\min} = Minimum composite steel-deck slab coefficient per section property tables

SUPPORT CONNECTION TENSION FLEXIBILITY

The flexibility of support connection in tension shall be determined in accordance with Eq. T-1:

$$S_t = 1 / (1706 \cdot t^2 \cdot d_w + 2.51) \quad [\text{Eq. T-1}]$$

Where:

S_t = Structural support connection tension flexibility (in/k)

d_w = Diameter of support connection or fastener (in.)

t = Base steel thickness of panel (in.)

SUPPORT CONNECTION SHEAR RUPTURE STRENGTH

The support connection shear rupture strength for the steel deck shall be determined in accordance with Eq. R-1:

$$P_{nv} = 2 \cdot F_u \cdot t \cdot (e - d/2) \quad \Omega = 2.75 \text{ (ASD)} \quad \phi = 0.60 \text{ (LRFD)} \quad \phi = 0.60 \text{ (LSD)} \quad [\text{Eq. R-1}]$$

Where:

P_{nv} = Nominal support connection shear rupture strength (kips)

F_u = Tensile strength of sheet steel (ksi)

t = Base steel thickness of panel (in.)

e = Distance between center of connection and edge of sheet (parallel to force) (in.)

d = Visible weld diameter or fastener shank diameter (in.)

CELLULAR DECK INTERMITTENT FASTENERS

The nominal shear strength [resistance] for intermittent fasteners used to connect the top fluted profile to the bottom pan shall be determined in accordance with Eq. C-1:

$$P_{nv} = 144 \cdot t^{1.47} \quad \Omega = 2.35 \text{ (ASD)} \quad \phi = 0.65 \text{ (LRFD)} \quad \phi = 0.55 \text{ (LSD)} \quad [\text{Eq. C-1}]$$

Where:

t = Base steel thickness of panel or bottom pan (in.)



DIAPHRAGM SHEAR STRENGTH AND STIFFNESS

Diaphragm shear strength and stiffness shall be calculated per AISI S310-16 with the following modifications:

D1 Diaphragm Shear Strength per Unit Length Controlled by Connection Strength, S_{nf}

The nominal shear strength [resistance] per unit length of a diaphragm controlled by connection strength, S_{nf} , shall be the smallest of S_{nc} , S_{ne} , and S_{np} .

$$S_{np} = \text{minimum} \left(n_d P_{nf} \frac{12}{w_t} \right) \quad \begin{array}{l} \text{[Eq. D1-4a]} \\ \text{For Fluted Panels} \end{array} \quad S_{np} = NP_{nf} \quad \begin{array}{l} \text{[Eq. D1-4b]} \\ \text{For Cellular Deck} \end{array}$$

Where

- S_{np} = Nominal shear strength [resistance] per unit length of diaphragm controlled by connections along the edge perpendicular to the panel span and located at exterior support, kip/ft
- n_d = Number of support connections at any given bottom flute along a panel end perpendicular to the panel span and located at exterior support
- w_t = Greatest tributary width to any given bottom flute with support connections along the edge perpendicular to the panel span and located at exterior support, in.

All other variables are as defined in AISI S310-16 Section D1

D2.1 Fluted Panel

The nominal diaphragm shear strength [resistance] per unit length, S_{nb} , for either acoustic or non-acoustic fluted panels shall be the smallest of S_{no} and S_{nl} .

$$S_{no} = \alpha \frac{7890}{L_v^2} \left(\frac{I_{xg}^3 t^3 d}{s} \right)^{0.25} \quad \text{[Eq. D2.1-1]} \quad S_{nl} = P_n \frac{d - e}{D_d} \left(\frac{12}{d} \right) \quad \text{[Eq. D2.1-2]}$$

Where

- α = 1.00 for panels fastened to support at every bottom flute at exterior supports
- 0.75 for panels not fastened to support at every bottom flute at exterior supports
- S_{no} = Nominal diaphragm shear strength [resistance] per unit length controlled by panel out-of-plane buckling, kip/ft
- S_{nl} = Nominal diaphragm shear strength [resistance] per unit length controlled by exterior support local web buckling, kip/ft
- d = Panel corrugation pitch, in.
- e = One-half the bottom flat width of panel measured between points of intercept, in.
- D_d = Depth of panel, in.

$$P_n = 4.36t^2 F_y \cdot \sin \theta \cdot \left(1 - 0.04 \sqrt{\frac{R}{t}} \right) \left(1 + 0.25 \sqrt{\frac{N_e}{t}} \right) \left(1 - 0.025 \sqrt{\frac{h_w}{q_s t}} \right) \quad \text{[Eq. D2.1-3]}$$

Where

- t = Base steel thickness of panel, in.
- F_y = Design yield stress, ksi
- θ = Angle between plane of web and plane of bearing surface, deg.
- R = Inside bend radius, in.
- N_e = Bearing Length at end of panel support, in.
- h_w = Flat dimension of web measured in plane of web, in.
- q_s = Perforated web reduction factor

D5.1.1 Stiffness of Fluted Panels

The diaphragm stiffness, G' shall be calculated in accordance with modified AISI S310-16 Eq. D5.1.1-1

$$G' = \left(\frac{Et}{2(1 + \mu) \frac{s}{d} + \gamma_c \alpha D_n + C} \right) K \quad \text{[Eq. D5.1.1-1]} \quad \begin{array}{l} \text{Where } \alpha = 1.00 \text{ for panels with butted end laps at both ends} \\ \quad \quad \quad 0.50 \text{ for panels with butted end laps at one end} \\ \quad \quad \quad 0.00 \text{ for panels with lapped end laps at both ends} \end{array}$$

For spacing of fasteners connecting panels along longitudinal edges parallel to the deck flutes greater than the interior side-lap seam fastener spacing:

$$d_e \leq \frac{S_s}{S_f} d_s \quad \text{[Eq. G]} \quad \begin{array}{l} \text{Where:} \\ d_e = \text{Spacing of parallel edge fasteners} \\ d_s = \text{Spacing of sidelap fasteners} \\ S_s = \text{Sidelap connection flexibility (in/kip)} \\ S_f = \text{Structural support connection flexibility (in/k)} \end{array}$$



DIAPHRAGM SHEAR STRENGTH AND STIFFNESS OF STRUCTURAL CONCRETE FILLED STEEL DECK-SLABS

For structural concrete deck-slabs with a concrete thickness above the top of the deck no less than 2 in. or greater than 6 in., the nominal shear strength per unit length of diaphragms with structural concrete fill is calculated in accordance with Eq. C-1 and the diaphragm stiffness is calculated in accordance with Eq. C-4.

$$S_n = S_c + S_f \quad \Omega = 2.00 \text{ (ASD)} \quad \phi = 0.80 \text{ (LRFD)} \quad \phi = 0.70 \text{ (LSD)} \quad \text{[Eq. C-1]}$$

$$S_c = k_c \cdot \lambda \cdot b \cdot \left[\left(D_c + \frac{D_d}{2} \right) + t \cdot \left(\frac{E}{E_c} \right) \cdot \left(\frac{d}{s} \right) \right] \cdot \sqrt{f'_c} \quad \text{[Eq. C-2]}$$

$$\begin{aligned} \text{For } D \geq 35 \text{ pcy, } S_f &= 0.37 \cdot f_{150} \cdot \left(D_c + \frac{D_d}{2} \right) \quad \text{[Eq. C-3]} \\ \text{For } D < 35 \text{ pcy, } S_f &= 0.00 \end{aligned}$$

$$G' = 4.8 \cdot \left[\left(D_c + \frac{D_d}{2} \right) + t \cdot \left(\frac{E}{E_c} \right) \cdot \left(\frac{d}{s} \right) \right] \cdot \sqrt{f'_c} \quad \text{[Eq. C-4]}$$

For structural concrete deck-slabs utilizing Vulcraft deck profiles and Bekaert Dramix 4D 65/60 BG Steel Fibers installed in accordance with IAPMO UES ER-465, steel fiber reinforced concrete properties are determined in accordance with Eq. BD-1

For 20 pcy ≤ D ≤ 66 pcy

$$f_{r1}, f_{r4}, f_{150}, R_{T,150}^D = C_1 \cdot \left(\frac{D}{\sqrt{f'_c}} \right)^2 + C_2 \cdot \left(\frac{D}{\sqrt{f'_c}} \right) \quad \text{[Eq. BD-1]}$$

	f_{r1}	f_{r4}	f_{150}	$R_{T,150}^D$
C_1	-81	-127	-127	-30
C_2	537	507	507	105

Where:

- S_n = Nominal shear strength per unit length of diaphragm system with concrete fill, k/ft (kN/m)
 - S_c = Shear strength of steel deck and structural concrete calculated in accordance with Eq. C-2, k/ft (kN/m)
 - S_f = Bekaert Dramix® steel fiber contribution to shear strength calculated in accordance with Eq. C-3, k/ft (kN/m)
 - G' = Shear stiffness of concrete deck-slab diaphragm, k/in
 - k_c = Factor for structural concrete strength = 3.2/1000 for U.S. customary units and 0.266/1000 for SI units
 - λ = 1.00 for normal weight concrete and 0.75 for lightweight concrete
 - b = Unit width of diaphragm with structural concrete fill = 12 in. for U.S. customary units and 1000 mm for SI units
 - D_c = Depth of concrete cover above steel deck flutes, in. (mm)
 - D_d = Depth of steel deck, in. (mm)
 - D = Fiber dosage, pcy
 - t = Base steel thickness of panel, in. (mm)
 - E = Modulus of elasticity of steel
 - E_c = Modulus of elasticity of concrete in accordance with ACI 318
 - d = Panel corrugation pitch, in. (mm)
 - s = Developed flute width of single corrugation, in. (mm)
 - f'_c = Structural concrete compressive strength, psi (Mpa) ≥ 2500 psi (17.2 MPa)
 - f_{150} = Stress at L/150 (psi)
- All other variables as defined in IAPMO UES ER-465

STRUCTURAL CONCRETE FILLED STEEL DECK-SLAB SHEAR TRANSFER TO CHORDS AND COLLECTORS

Shear transfer of structural concrete fill deck-slab to chords and collectors shall be in accordance with AISI S310-16 Section D4.4 including D4.4.1 with safety and resistance factors for connections of the composite deck slab to supports as follows:

1. Steel headed stud anchors with nominal shear strength determined in accordance with AISC 360 with the following factors:
 $\Omega = 3.00 \text{ (ASD)} \quad \phi = 0.55 \text{ (LRFD)} \quad \phi = 0.50 \text{ (LSD)}$
2. Available strength [factored resistance] for Shearflex standoff screw fastener shall be determined in accordance with this report, Ω and ϕ are listed on Page 13 of this report.
3. Available strength [factored resistance] for welds shall be determined in accordance with AISI S100-16.
4. Available strength [factored resistance] for screws shall be determined in accordance with AISI S100-16.
5. Available strength [factored resistance] for proprietary fasteners shall be determined in accordance with this report, Ω and ϕ are listed on Page 15 of this report.



STEEL ROOF DECK DIAPHRAGM LENGTH FOR DIFFERENTIAL THERMAL EFFECTS

The length, L , and width, b , of the roof diaphragm, in accordance with the definition sections of the IBC or ASCE 7, including the steel roof deck, support members (framing), chords and collectors shall be permitted to be of unlimited length between joints for differential thermal expansion or contraction (thermal expansion joints) provided the following conditions exist:

- a. Vertical Load system, including the vertical lateral force resisting system, does not have Building Separation Joints, Seismic Joints, Expansion joints or similar joints that interrupt the diaphragm chord with respect to the area of the diaphragm under consideration.
- b. Wall systems, both perimeter and interior, to be constructed as continuous walls, individual wall panels, or wall segments. Individual wall panels or wall segments are permitted to be precast concrete walls, site cast concrete walls, tilt-up concrete walls, masonry walls with or without crack control joints, stud wall system with or without crack control joints, or wind girt framed wall systems with or without crack control joints. A combination of these systems may be used. See Figures A and B.
- c. Diaphragm has continuous chord members and a positive load path capable of transferring diaphragm forces between the diaphragm and the Vertical Lateral Force Resisting System.
- d. Steel Roof Deck Diaphragm is covered by a roofing membrane system; deck is not directly exposed to sun or elements in final occupied condition.
- e. Steel roof deck support members consists of one or a combination of the following.
 - 1. Vulcraft Open Web Steel Joists and Joist Girders in accordance with SJI-100.
 - 2. Structural Steel members in accordance with AISC 360.
 - 3. Cold-Formed Steel members in accordance with AISI S100.
 - 4. Bearing walls.
- f. Steel Roof Deck Diaphragm Attachment:
 - 1. Sidelap Connection: PunchLok II System with VSC2 sidelap connections.
 - 2. Connection to Supports: Hilti X-HSN 24 or X-ENP-19 Power Actuated Fasteners.

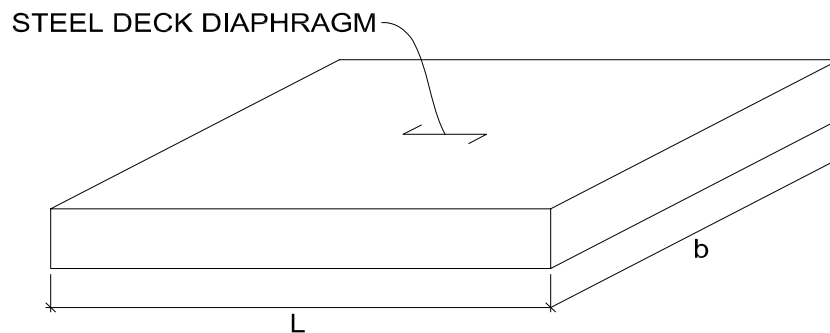

Figure A: Structure with Continuous Walls

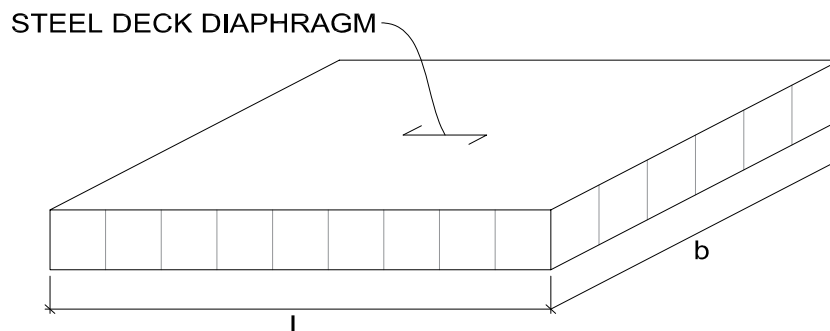

Figure B: Structure with Individual Wall Panels or Wall Segments

PROPRIETARY FASTENERS

PunchLok II System

The nominal shear strength [resistance] for PunchLok II System (VSC2) connection shall be determined in accordance with Eq. PL-1:

$$P_{ns} = 137.42 \cdot t - 2.01 \quad [\text{Eq. PL-1}]$$

The flexibility of PunchLok II System (VSC2) connection shall be determined in accordance with Eq. PL-2:

$$S_s = \frac{0.012}{1000 \cdot t^2} \quad [\text{Eq. PL-2}]$$

- ① PunchLok® II system connection - as shown the 2 deformations of male and female sheets are projecting through the female sheet. However, the VSC2 may be made in either direction
- ② Sheared surface of male leg.
- ③ Sheared surface of female leg.
- ④ Male leg / sheet.
- ⑤ Female leg / sheet.

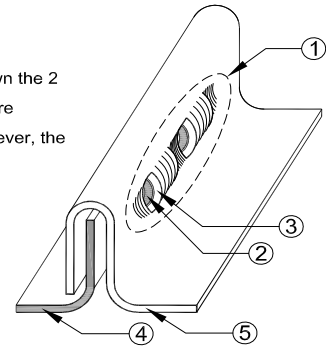

Simpson Strong-Tie

The nominal shear strength [resistance] for the Simpson XL Screw shall be determined in accordance with Eq. S-1:

$$P_{nf} = 78 \cdot t \cdot (t_{\text{support}})^{0.15} \leq P_{nvs} \quad [\text{Eq. S-1}]$$

The nominal shear strength [resistance] for the Simpson XM Screw shall be determined in accordance with Eq. S-2a or S-2b:

$$\text{For } t_{\text{support}} \leq 0.1875 \text{ in} \quad P_{nf} = 240 \cdot (t)^{1.5} \leq P_{nvs} \quad [\text{Eq. S-2a}]$$

$$\text{For } t_{\text{support}} > 0.1875 \text{ in} \quad P_{nf} = 53 \cdot t \leq P_{nvs} \quad [\text{Eq. S-2b}]$$

The nominal shear strength [resistance] for the Simpson X1S1016 or XQ1S1016 shall be determined in accordance with Eq. S-3:

$$P_{ns} = 20 \cdot t \leq 1.625 \quad [\text{Eq. S-3}]$$

The nominal shear strength [resistance] for the Simpson XU34B1016 shall be determined in accordance with Eq. S-4:

$$P_{ns} = 25.2 \cdot t \leq 1.735 \quad [\text{Eq. S-4}]$$

Where:

t = Base steel thickness of panel (in.)

t_{support} = Thickness of support (in.)

S_s = Sidelap connection flexibility (in/kip)

S_f = Structural support connection flexibility (in/k)

P_{nf} = Nominal shear strength [resistance] of a support connection (kips)

P_{ns} = Nominal shear strength [resistance] of a side-lap connection per fastener (kips)

P_{nvs} = Nominal shear strength [resistance] of screw (see page 11)



PROPRIETARY FASTENERS (Continued)

Hilti

The nominal shear strength [resistance] for the Hilti X-ENP-19 L15 PAF shall be determined in accordance with Eq. H-1:

$$P_{nf} = 56 \cdot t \cdot (1 - t) \leq P_{nvp} \quad [\text{Eq. H-1}]$$

The nominal shear strength [resistance] for the Hilti X-HSN24 PAF shall be determined in accordance with Eq. H-2:

$$P_{nf} = 52 \cdot t \cdot (1 - t) \leq P_{nvp} \quad [\text{Eq. H-2}]$$

The flexibility of the Hilti X-ENP-19 L15 shall be determined in accordance with Eq. H-3a:

$$S_f = \frac{0.75}{1000\sqrt{t}} \quad [\text{Eq. H-3a}]$$

The flexibility of the Hilti X-HSN 24 PAF shall be determined in accordance with Eq. H-3b:

$$S_f = \frac{1.25}{1000\sqrt{t}} \quad [\text{Eq. H-3b}]$$

The nominal tension strength [resistance] for the Hilti X-HSN 24 controlled by pull-out shall be determined in accordance with Eq. H-4:

$$P_{not} = 8 \cdot t_{\text{support}} + 0.088 \leq 1.875 \quad \Omega = 2.50 \text{ (ASD)} \quad \phi = 0.65 \text{ (LRFD)} \quad \phi = 0.55 \text{ (LSD)} \quad [\text{Eq. H-4}]$$

The nominal tension strength [resistance] for the X-ENP-19 L15 controlled by pull-out shall be determined in accordance with Eq. H-5:

$$P_{not} = 2.625 \quad \Omega = 2.50 \text{ (ASD)} \quad \phi = 0.65 \text{ (LRFD)} \quad \phi = 0.55 \text{ (LSD)} \quad [\text{Eq. H-5}]$$

Shearflex Standoff Screws

The nominal shear strength [resistance] for the Shearflex Standoff Screw shall be determined in accordance with Eq. F-1 or F-2:

For 1.5C Inverted, 1.5B, 1.5VL, 1.5BI, 1.5PLB, 1.5VLI, 1.5PLVLI, 1.5BP, 1.5PLBP, 1.5VLP, 1.5PLVLP, 1.0C

$$P_{nf} = 4.650 \quad \Omega = 2.85 \text{ (ASD)} \quad \phi = 0.55 \text{ (LRFD)} \quad \phi = 0.45 \text{ (LSD)} \quad [\text{Eq. F-1}]$$

For 1.5C and 1.5VLR

$$P_{nf} = 7.044 \quad \Omega = 2.85 \text{ (ASD)} \quad \phi = 0.55 \text{ (LRFD)} \quad \phi = 0.45 \text{ (LSD)} \quad [\text{Eq. F-2}]$$

Where:

t = Base steel thickness of panel (in.)

t_{support} = Thickness of support (in.)

S_f = Structural support connection flexibility (in/k)

P_{nf} = Nominal shear strength [resistance] of a support connection (kips)

P_{ns} = Nominal shear strength [resistance] of a side-lap connection per fastener (kips)

P_{nvp} = Nominal shear strength [resistance] of PAF (see page 11)

P_{not} = Nominal tensile strength [resistance] of a support connection per fastener controlled by pull-out (kips)

φ = Resistance Factor

Ω = Safety Factor



PROPRIETARY FASTENERS (Continued)

Pneutek

The nominal shear strength [resistance] for the Pneutek SDK61 PAF shall be determined in accordance with Eq. P-1a and P-1b:

For substrate thickness equal to 0.113"

$$P_{nf} = 0.735 \cdot t \cdot F_u(1 - 0.016 \cdot t \cdot F_u) \leq P_{nvp} \quad [\text{Eq. P-1a}]$$

For substrate thickness equal to 0.155"

$$P_{nf} = 0.788 \cdot t \cdot F_u(1 - 0.028 \cdot t \cdot F_u) \leq P_{nvp} \quad [\text{Eq. P-1b}]$$

For substrate thickness between 0.113" and 0.155", P_{nf} shall be determined by interpolation.

The nominal shear strength [resistance] for the Pneutek SDK63, K64 and K66 PAF shall be determined in accordance with Eq. P-2:

$$P_{nf} = 1.264 \cdot t \cdot F_u(1 - 0.053 \cdot t \cdot F_u) \leq P_{nvp} \quad [\text{Eq. P-2}]$$

The flexibility of the Pneutek SDK61 PAF shall be determined in accordance with Eq. P-3:

$$S_f = \frac{3}{1000\sqrt{t}} \quad [\text{Eq. P-3}]$$

The flexibility of the Pneutek SDK63, K64 and K66 PAF shall be determined in accordance with Eq. P-4a and P-4b:

For substrate thickness less than 0.25"

$$S_f = \frac{3}{1000\sqrt{t}} \quad [\text{Eq. P-4a}]$$

For substrate thickness equal to or greater than 0.25"

$$S_f = \frac{1}{1000\sqrt{t}} \quad [\text{Eq. P-4b}]$$

The nominal tension strength [resistance] for the Pneutek SDK61, SDK63, K64 and K66 PAF controlled by pull-out shall be determined in accordance with Eq. P-5:

$$P_{not} = 18.37 \cdot t_{support} \leq 4.811 \quad \Omega = 2.45 \text{ (ASD)} \quad \phi = 0.65 \text{ (LRFD)} \quad \phi = 0.55 \text{ (LSD)} \quad [\text{Eq. P-5}]$$

Where:

P_{not} = Nominal tensile strength [resistance] of a support connection per fastener controlled by pull-out (kips)

P_{nf} = Nominal shear strength [resistance] of a support connection per fastener (kips)

t = Base steel thickness of panel (in.)

F_u = Ultimate strength of sheet steel (ksi)

P_{nvp} = Nominal shear strength [resistance] of PAF (see page 11)

$t_{support}$ = Thickness of support (in.)

S_f = Structural support connection flexibility (in/k)

ϕ = Resistance Factor

Ω = Safety Factor



PROPRIETARY SUPPORT FASTENER PROPERTIES								
Specified Properties	Hilti		Pneutek				Simpson Strong-Tie	
	X-HSN 24	X-ENP-19	SDK61	SDK63	K64	K66	XM Screw	XL Screw
Minimum Substrate Thickness (in)	0.125	0.250	0.113	0.155	0.187	0.281	0.125	0.125
Maximum Substrate Thickness (in)	0.375	∞	0.155	0.250	0.312	∞	0.610	0.610
Shank Diameter (in)	0.157	0.177	0.144	0.173	0.181	0.199	0.216	0.216
Head or Washer Diameter (in)	0.474	0.591	0.500	0.500	0.500	0.500	0.483	0.625
Nominal Tensile Strength based on Material strength, P_{nts} (kip) ¹	5.033 $\Omega = 2.65$ (ASD) $\phi = 0.60$ (LRFD) $\phi = 0.50$ (LSD)	6.397	3.909	5.641 $\Omega = 2.65$ (ASD) $\phi = 0.60$ (LRFD) $\phi = 0.50$ (LSD)	6.175	7.465	4.985 $\Omega = 3.00$ (ASD) $\phi = 0.50$ (LRFD) $\phi = 0.40$ (LSD)	4.985
Nominal Shear Strength of Screw based on Material Strength, P_{nvs} (kip) ²	-	-	-	-	-	-	3.110 $\Omega = 3.00$ (ASD) $\phi = 0.50$ (LRFD) $\phi = 0.40$ (LSD)	3.110
Nominal Shear Strength of PAF based on Material Strength, P_{nvp} (kip) ³	3.020 $\Omega = 2.65$ (ASD) $\phi = 0.60$ (LRFD) $\phi = 0.50$ (LSD)	3.838	2.345	3.385 $\Omega = 2.65$ (ASD) $\phi = 0.60$ (LRFD) $\phi = 0.50$ (LSD)	3.705	4.479	-	-
Individual Fastener Shear Strength, P_{nf} ⁴	$\Omega = 2.30$ (ASD) $\phi = 0.70$ (LRFD) $\phi = 0.55$ (LSD)			$\Omega = 2.40$ (ASD) $\phi = 0.65$ (LRFD) $\phi = 0.55$ (LSD)			$\Omega = 3.00$ (ASD) $\phi = 0.50$ (LRFD) $\phi = 0.40$ (LSD)	

¹ Determined in accordance with AISI S100-16 Section J5.2.1 and J4.4.3

² Determined in accordance with AISI S100-16 Section J4.3.2

³ Determined in accordance with AISI S100-16 Section J5.3.1

⁴ For use when calculating individual fastener shear strength in accordance with equations listed on pages 13-15 of this report.

⁵ The shear strength of the connection shall be the minimum of the allowable strength for ASD, the design strength for LRFD, or the factored strength for LSD of the individual fastener shear strength and the shear strength based on material strength.



MAXIMUM DIAPHRAGM SHEAR BETWEEN OPENINGS REINFORCED WITH COLD-FORMED STEEL CURBS ^{1,2a-f}							
Deck Profile	Deck Gage	ASD - Allowable Diaphragm Shear, S_n/Ω (plf)			LRFD - Design Diaphragm Shear, ϕS_n (plf)		
		Span Length (ft-in)			Span Length (ft-in)		
		6'-0"	8'-0"	10'-0"	6'-0"	8'-0"	10'-0"
1.5PLB-36 1.5BI-36	22	1127	1116	-	1831	1814	-
	20	1408	1398	1313	2288	2272	2134
	18	1929	1920	1914	3135	3120	3110

¹ S_n = Nominal shear strength [resistance] per unit length of diaphragm system

² Roof openings may be reinforced with cold-formed steel curbs on top of the steel roof deck without below deck support frames, as shown below subject to the following conditions a-f:

- ^a The diaphragm shear strengths shall not exceed the lesser of this table or the calculated shear strength.
- ^b Opening shall span between joists or beams shown in figure below.
- ^c Cold-formed steel curbs be shall be a minimum of ASTM A653 Commercial Quality or equivalent steel specification.
- ^d Cold-Formed steel curbs shall meet the dimensions as shown in figure below.
- ^e Cold-Formed steel curbs shall have the minimum attachments to the steel roof deck as shown in figure below.
- ^f Deck may be end lapped, butted, or continuous between openings.

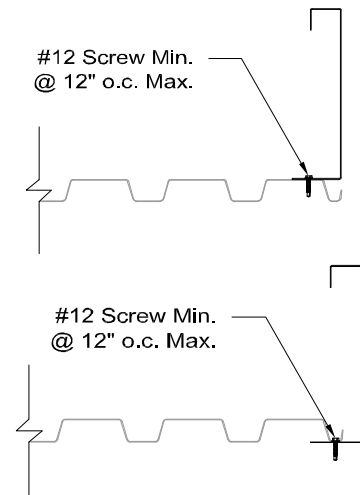
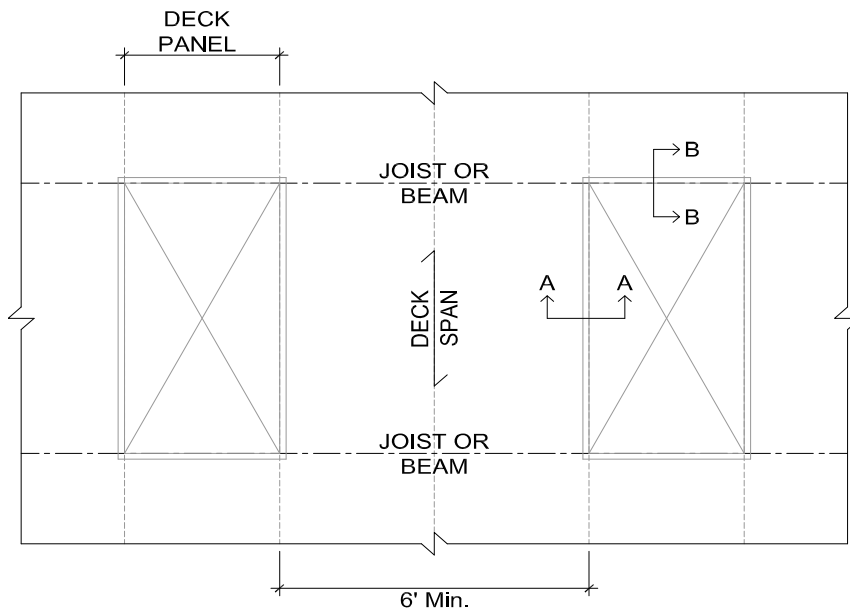

A-A: Minimum Roof Curb Attachment
(Edge Parallel to Deck)

Recommended Opening Layout

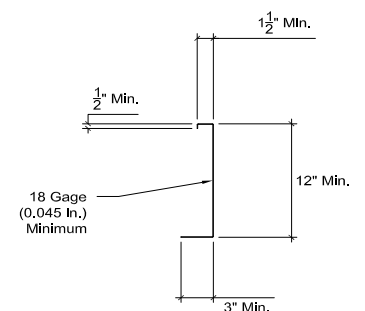

Minimum Roof Curb Dimensions

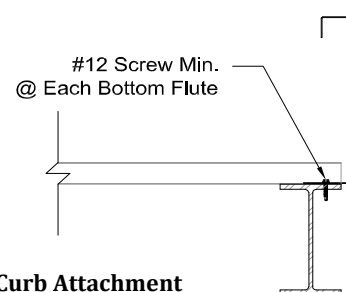
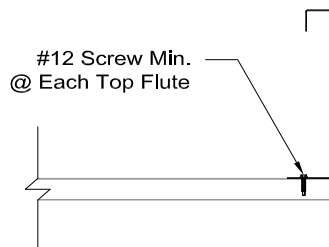

B-B: Minimum Roof Curb Attachment
(Edge Perpendicular to Deck)



1.5PLB-36 OR 1.5BI-36 ROOF DECK SPANS FOR CONCENTRATED LOADS ¹⁻⁴				
Deck Gage	Number of Spans	Maximum Span based on Live Load Deflection		
		L / 360	L / 240	L / 180
22	1	6'-5"	8'-1"	9'-10"
	2	7'-1"	10'-0"	11'-10"
	3	7'-2"	10'-0"	11'-10"
20	1	7'-4"	9'-9"	12'-0"
	2	9'-5"	12'-10"	14'-10"
	3	9'-8"	13'-3"	≥ 14'-0"
18	1	8'-10"	11'-8"	13'-8"
	2	11'-3"	14'-10"	16'-2"
	3	11'-3"	≥ 14'-0"	≥ 14'-0"
16	1	10'-4"	14'-6"	17'-9"
	2	13'-1"	18'-6"	20'-11"
	3	13'-4"	14'-0"	14'-0"

¹ Deflection values based on a 300 lbs concentrated roof live load.

² Concentrated load distributed over a 2-1/2 ft x 2-1/2 ft per IBC section 1607.4.

³ Concentrated load deflections based on an assembly that includes a minimum of 2 layers of 1-1/2" ASTM C 1289, Type II, Class 1, Grade 2 (20 psi) polyisocyanurate insulation board on the steel deck.

⁴ Table is limited to the maximum available sheet length of 42'-0". For longer sheet lengths, please contact Vulcraft.

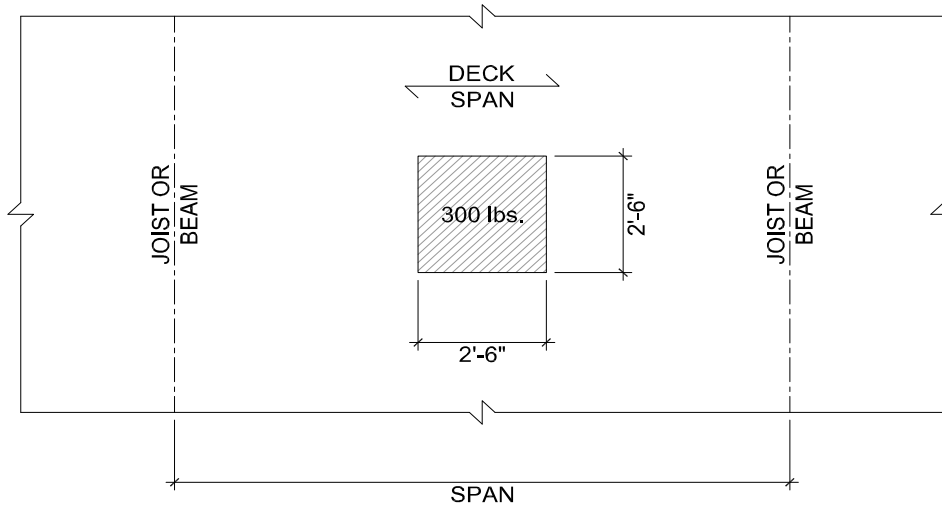

Load Placement Bare Deck - Plan View

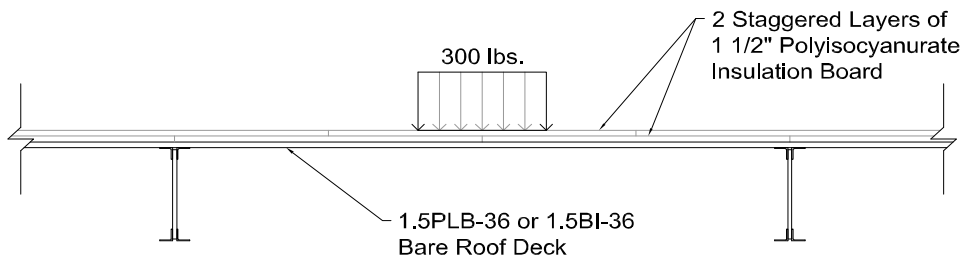

Load Placement Bare Deck



ITW BUILDEX SAMMYS X-PRESS CONNECTION ¹⁻⁸									
SAMMYS X-Press Type			Deck Gage	Solid Material (Gr. 50)			Perforated Material (Gr. 50)		
Part Number	Model Number ²⁻⁴	Rod Size (in.)		ASD P_{not}/Ω (lbs)	LRFD ϕP_{not} (lbs)	Max. Fire Sprinkler Pipe Size ⁷ (in.)	ASD P_{not}/Ω (lbs)	LRFD ϕP_{not} (lbs)	Max. Fire Sprinkler Pipe Size ⁷ (in.)
8181922	XP 200	1/4	22	328	521	2 1/2	229	359	2
8150922	XP 20	3/8	20	398	632	2 1/2	278	435	2
8294922	SXP 20	3/8	19	464	738	3	324	508	2 1/2
8272957	SXP 2.0	1/2	18	527	837	3 1/2	368	576	2 1/2
8181922	XP 200	1/4	16	664	1056	4	464	727	3 1/2
8295922	XP 35	3/8							
8295922	SXP 35	3/8							
8271957	SXP 3.5	1/2							

¹ For Solid: $P_{not} = 0.453 \cdot t \cdot F_u$ $\Omega = 2.65$ (ASD) $\phi = 0.60$ (LRFD)

For Perforated: $P_{not} = 0.340 \cdot t \cdot F_u$ $\Omega = 2.85$ (ASD) $\phi = 0.55$ (LRFD)

Where P_{not} = Nominal pullout strength of SAMMYS X-Press Connector, kips

² XP 200 may not be used to support sprinkler pipe.

³ XP 200, XP 20 and XP 35 shall be installed and loaded perpendicular to the deck surface.

⁴ SXP 20, SXP 2.0, SXP 35 and SXP 3.5 may be installed in any flat portion of the bottom flange, web or top flange. The load may be applied at any angle, θ , from 0 to 90 degrees, $0^\circ \leq \theta \leq 90^\circ$, relative to the axis of the base of the connector and any angle, α , from 0 to 360 degrees, $0^\circ \leq \alpha \leq 360^\circ$, relative to the ribs of the steel deck as shown below.

⁵ The allowable strength, P_n/Ω , shall be equal to or greater than the governing nominal load or load combination for Allowable Stress Design (ASD) as stipulated in the IBC or ASCE/SEI 7.

⁶ The factored strength, ϕP_n , shall be equal to or greater than the governing factored load or factored load combination for Load and Resistance Factor Design as stipulated in the IBC or ASCE/SEI 7.

⁷ Maximum fire sprinkler pipe size in accordance with NFPA 13.

⁸ SAMMYS X-Press shall be installed per manufacturers instructions.

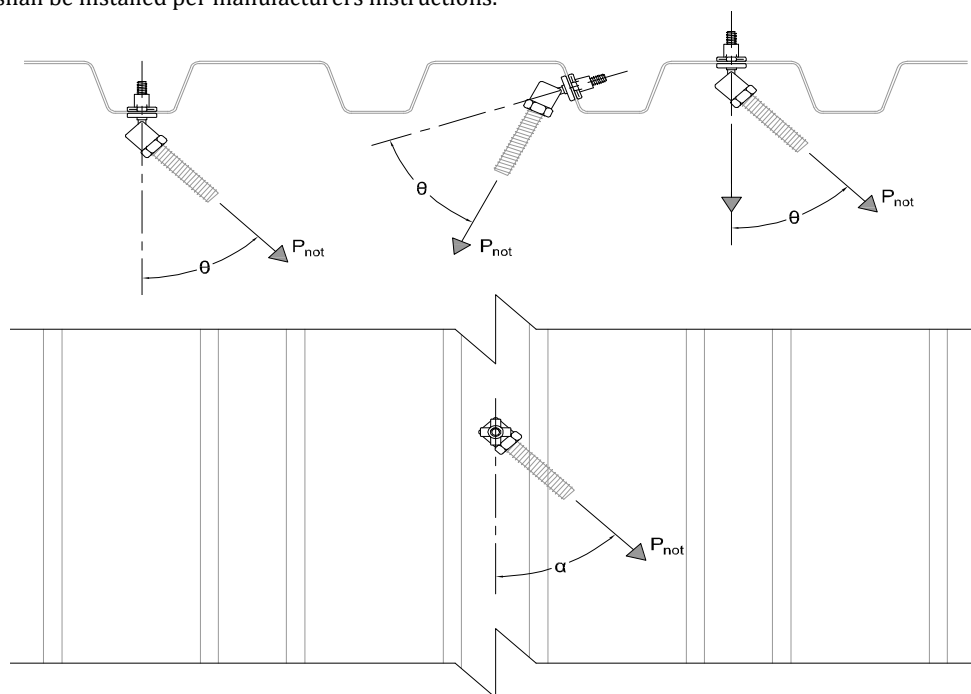

Sammy X-Press Swivel Head[®] Connector



DEFINITION OF SECTION PROPERTY SYMBOLS

Symbol	Definition	Units
A_g	Gross area of cross-section	in ² /ft
A_{gbf}	Gross area of bottom flange	in ²
A_{gtf}	Gross area of top flange	in ²
A_n	Net area of cross-section, $A_n=A_g$ for non-perforated profiles	in ² /ft
A_{sbf}	Cross-sectional area of bottom flange stiffener	in ²
A_{stf}	Cross-sectional area of top flange stiffener	in ²
b_{obf}	Overall flat width of stiffened bottom flange	in.
b_{otf}	Overall flat width of stiffened top flange	in.
b_{pbf}	Largest sub-element flat of stiffened bottom flange	in.
b_{ptf}	Largest sub-element flat of stiffened top flange	in.
c_p	Perforation hole center-to-center spacing	in.
c_{sbf}	Horizontal distance from edge of bottom flange to centerline of bottom flange stiffener	in.
c_{stf}	Horizontal distance from edge of top flange to centerline of top flange stiffener	in.
d_p	Perforation hole diameter	in.
E	Modulus of elasticity of steel = 29,500	ksi
E_p	Width of perforated band in bottom flange	in.
F_p	Width of perforated band in top flange	in.
F_u	Tensile strength of steel	ksi
F_y	Yield strength of steel	ksi
G	Shear modulus of steel = 11,300	ksi
h_w	Flat dimension of web measured in plane of web	in.
I_{d+}	Positive effective moment of inertia for deflection due to uniform loads, $I_{d+}=(2I_{e+}+I_x)/3$	in ⁴ /ft
I_{d-}	Negative effective moment of inertia for deflection due to uniform loads, $I_{d-}=(2I_{e-}+I_x)/3$	in ⁴ /ft
I_{e+}	Positive effective moment of inertia	in ⁴ /ft
I_{e-}	Negative effective moment of inertia	in ⁴ /ft
I_{spbf}	Moment of inertia of stiffener about centerline of flat portion of bottom flange	in ⁴
I_{sptf}	Moment of inertia of stiffener about centerline of flat portion of top flange	in ⁴
I_{xg}	Moment of inertia of fully effective section	in ⁴ /ft
K	Composite deck-slab coefficient	-
M_{n+}	Nominal positive flexural strength of deck or panel, $M_{n+}=F_y \cdot S_{e+}$	k-ft/ft
M_{n-}	Nominal negative flexural strength of deck or panel, $M_{n-}=F_y \cdot S_{e-}$	k-ft/ft
M_{nxt+}	Nominal positive flexural strength with respect to centroidal axes in considering tension yielding	k-ft/ft
M_{nxt-}	Nominal negative flexural strength with respect to centroidal axes in considering tension yielding	k-ft/ft
q_s	Perforated web reduction factor	-
R	Inside bend radius	in.
r	Radius of gyration of gross section, $r=(I_{xg}/A_g)^{0.5}$	in.

**DEFINITION OF SECTION PROPERTY SYMBOLS**

Symbol	Definition	Units
S_{bp}	Spacing of intermittent fasteners connecting panel to bottom pan for cellular deck	in.
S_{e+}	Positive effective section modulus	in ³ /ft
S_{e-}	Negative effective section modulus	in ³ /ft
S_{xb}	Section modulus about the X axis for the extreme top fiber of gross section, $S_{xb}=I_{xg}/y_b$	in ³ /ft
S_{xt}	Section modulus about the X axis for the extreme bottom fiber of gross section, $S_{xt}=I_{xg}/y_t$	in ³ /ft
T_n	Nominal tensile axial strength of panel	k/ft
t	Base steel thickness of panel	in.
t_b	Base steel thickness of bottom element in cellular deck	in.
V_n	Nominal vertical shear strength of panel	k/ft
V_{ni}	Nominal vertical shear capacity based on resistance weld strength (inverted deck orientation)	k/ft
V_{nn}	Nominal vertical shear capacity based on resistance weld strength (normal deck orientation)	k/ft
w_{bf}	Flat width of bottom flange	in.
w_{bp}	Flat width of bottom pan between resistance welds	in.
w_{dd}	Weight of deck	psf
W_p	Width of perforated band in web	in.
w_{tf}	Flat width of top flange	in.
y_b	Distance from extreme bottom fiber to neutral axis of gross section	in.
y_t	Distance from extreme top fiber to neutral axis of gross section	in.
θ	Angle between plane of web and plane of bearing surface	deg.



DEFINITION OF SECTION PROPERTY SYMBOLS

Symbol	Definition	Units
A_g	Gross area of cross-section	in ²
C_w	Torsional warping constant of cross-section	in ⁶
I_{xg}	Moment of inertia of gross section about x-axis	in ⁴
I_{yg}	Moment of inertia of gross section about y-axis	in ⁴
J	St. Venant torsion constant of cross-section	in ⁴
j_x	Asymmetry property for lateral-torsional buckling	in.
M_{crdx+}	Elastic Distortional Buckling Moment (+X)	k-in
M_{crdx-}	Elastic Distortional Buckling Moment (-X)	k-in
M_{crdy+}	Elastic Distortional Buckling Moment (+Y)	k-in
M_{crdy-}	Elastic Distortional Buckling Moment (-Y)	k-in
M_{crlx+}	Elastic Local Buckling Moment (+X)	k-in
M_{crlx-}	Elastic Local Buckling Moment (-X)	k-in
M_{crlx+}	Elastic Local Buckling Moment (+Y)	k-in
M_{crlx-}	Elastic Local Buckling Moment (-Y)	k-in
P_{crd}	Elastic Distortional Buckling Compression Force	k
P_{crl}	Elastic Local Buckling Compression Force	k
r_x	Radius of gyration of gross section about x-axis	in.
r_y	Radius of gyration of gross section about y-axis	in.
r_o	Polar radius of gyration about shear center	in.
S_{xb}	Section modulus about the X axis for the extreme top fiber of gross section, $S_{xb}=I_{xg}/y_b$	in ³
S_{xt}	Section modulus about the X axis for the extreme bottom fiber of gross section, $S_{xt}=I_{xg}/y_t$	in ³
S_{yl}	Section modulus about the Y axis for the extreme left fiber of gross section, $S_{yl}=I_{yg}/x_l$	in ³
S_{yr}	Section modulus about the Y axis for the extreme right fiber of gross section, $S_{yr}=I_{yg}/x_r$	in ³
x_o	Distance from centroid to shear center in principal x-axis direction	in.
y_o	Distance from centroid to shear center in principal y-axis direction	in.



Nestable Profiles

1.5B-36, 1.5B-30

Nestable Profiles (Embossed)

1.5VL-36

Interlocking Profiles

1.5BI-36, 1.5PLB-36

Interlocking Profiles (Embossed)

1.5VLI-36, 1.5PLVLI-36

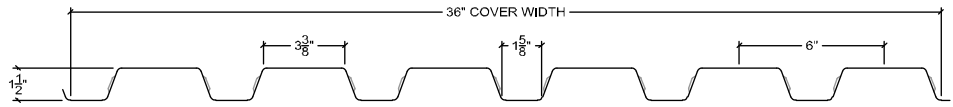

Gage	t in.	w _{dd} psf	A _g in ² /ft	I _{xg} in ⁴ /ft	S _{xb} in ³ /ft	S _{xt} in ³ /ft	y _b in.	y _t in.	r in.	h _w in.	θ deg.	K _{min} -
24	0.0239	1.3	0.387	0.147	0.165	0.244	0.892	0.602	0.616	1.279	70.3	-
22	0.0295	1.6	0.478	0.180	0.201	0.298	0.895	0.605	0.614	1.273	70.5	1.000
20	0.0358	2.0	0.580	0.217	0.242	0.357	0.898	0.608	0.612	1.266	70.7	1.000
19	0.0418	2.3	0.678	0.257	0.285	0.421	0.901	0.611	0.616	1.259	70.9	1.000
18	0.0474	2.6	0.769	0.290	0.321	0.472	0.904	0.614	0.614	1.252	71.1	1.000
16	0.0598	3.3	0.971	0.367	0.403	0.592	0.910	0.620	0.615	1.237	71.4	1.000

GRADE 50: F _y = 50 ksi, F _u = 65 ksi												
Gage	I _{e+} in ⁴ /ft	I _{e-} in ⁴ /ft	I _{d+} in ⁴ /ft	I _{d-} in ⁴ /ft	S _{e+} in ³ /ft	S _{e-} in ³ /ft	M _{n+} k-ft/ft	M _{n-} k-ft/ft	M _{nxt+} k-ft/ft	M _{nxt-} k-ft/ft	V _n k/ft	T _n k/ft
22	0.143	0.177	0.155	0.178	0.169	0.179	0.704	0.746	0.838	1.242	4.247	23.90
20	0.187	0.217	0.197	0.217	0.224	0.229	0.933	0.954	1.008	1.488	5.131	29.00
19	0.230	0.257	0.239	0.257	0.266	0.278	1.108	1.158	1.188	1.754	5.964	33.90
18	0.270	0.290	0.277	0.290	0.306	0.318	1.275	1.325	1.338	1.967	6.735	38.45
16	0.363	0.367	0.364	0.367	0.393	0.402	1.638	1.675	1.679	2.467	8.417	48.55

GRADE 80: F _y = 60 ksi, F _u = 62 ksi												
Gage	I _{e+} in ⁴ /ft	I _{e-} in ⁴ /ft	I _{d+} in ⁴ /ft	I _{d-} in ⁴ /ft	S _{e+} in ³ /ft	S _{e-} in ³ /ft	M _{n+} k-ft/ft	M _{n-} k-ft/ft	M _{nxt+} k-ft/ft	M _{nxt-} k-ft/ft	V _n k/ft	T _n k/ft
24	0.103	0.133	0.118	0.138	0.120	0.131	0.600	0.655	0.825	1.220	2.481	23.22
22	0.137	0.173	0.151	0.175	0.162	0.173	0.810	0.865	1.005	1.490	5.097	28.68
20	0.180	0.217	0.192	0.217	0.215	0.223	1.075	1.115	1.210	1.785	6.157	34.80
19	0.220	0.253	0.232	0.254	0.263	0.271	1.315	1.355	1.425	2.105	7.157	40.68
18	0.263	0.290	0.272	0.290	0.302	0.315	1.510	1.575	1.605	2.360	8.082	46.14

R	w _{tf}	w _{bf}
in.	in.	in.
0.188	3.062	1.325



Nestable Profiles

1.5B-36

Nestable Profiles (Embossed)

1.5VL-36

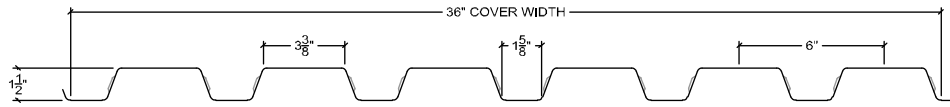

Interlocking Profiles

1.5BI-36, 1.5PLB-36

Interlocking Profiles (Embossed)

1.5VLI-36, 1.5PLVLI-36



GRADE 50

GRADE 80

Gage	A_g in ²	x_0 in.	y_0 in.	r_0 in.	j_x in.	C_w in ⁶	J in ⁴	P_{crl} k	P_{crd} k
22	1.4330	-0.325	0.187	10.648	0.345	63.830	0.000416	24.872	37.802
20	1.7400	-0.323	0.187	10.649	0.343	77.546	0.000743	42.259	48.775
19	2.0327	-0.322	0.187	10.650	0.342	90.636	0.001184	65.060	46.012
18	2.3061	-0.320	0.187	10.651	0.340	102.880	0.001727	92.736	56.135
16	2.9126	-0.317	0.188	10.653	0.337	130.070	0.003472	179.910	183.350

Gage	I_{xg} in ⁴	S_{xt} in ³	S_{xb} in ³	r_x in.	M_{crlx+} k-in	M_{crdx+} k-in	M_{crlx-} k-in	M_{crdx-} k-in
22	0.54	0.891	0.602	0.613	15.06	115.73	52.43	15.27
20	0.65	1.077	0.729	0.613	25.60	148.78	86.35	22.57
19	0.77	1.252	0.849	0.614	39.44	257.63	129.88	31.29
18	0.87	1.415	0.961	0.614	56.22	303.27	181.82	40.17
16	1.10	1.771	1.208	0.614	109.10	561.40	336.80	65.90

Gage	I_{yg} in ⁴	S_{yl} in ³	S_{yr} in ³	r_y in.	M_{crlx+} k-in	M_{crdy+} k-in	M_{crlx-} k-in	M_{crdy-} k-in
22	161.74	8.793	8.833	10.624	187.24	115.31	136.17	255.94
20	196.43	10.677	10.727	10.625	318.14	224.21	316.69	457.97
19	229.51	12.472	12.532	10.626	489.83	265.38	487.74	558.75
18	260.42	14.150	14.219	10.627	698.20	304.04	695.28	90.63
16	329.02	17.871	17.962	10.629	1354.60	590.40	620.80	1241.40



Nestable Profiles

3NL-32

Interlocking Profiles

3NI-32,

3PLN-32

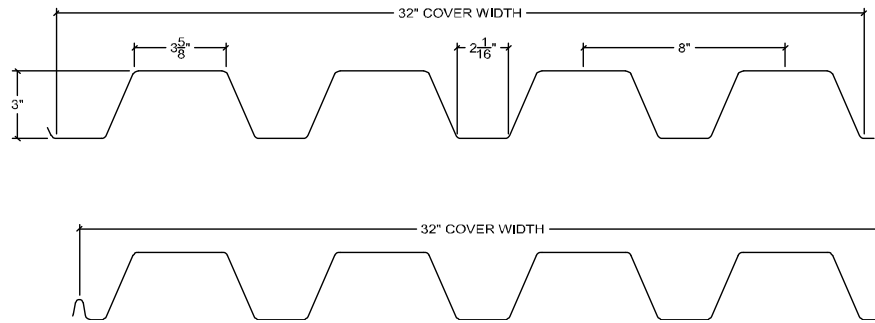

Gage	t in.	w _{dd} psf	A _g in ² /ft	I _{xg} in ⁴ /ft	S _{xb} in ³ /ft	S _{xt} in ³ /ft	y _b in.	y _t in.	r in.	h _w in.	θ deg.
22	0.0295	1.8	0.537	0.750	0.450	0.562	1.665	1.335	1.182	2.925	68.2
20	0.0358	2.2	0.652	0.911	0.546	0.681	1.668	1.338	1.182	2.919	68.3
19	0.0418	2.6	0.762	1.065	0.638	0.794	1.670	1.341	1.182	2.913	68.3
18	0.0474	2.9	0.864	1.208	0.722	0.899	1.673	1.344	1.182	2.907	68.4
16	0.0598	3.7	1.091	1.526	0.909	1.130	1.679	1.351	1.183	2.894	68.6

GRADE 50: F _y = 50 ksi, F _u = 65 ksi												
Gage	I _{e+} in ⁴ /ft	I _{e-} in ⁴ /ft	I _{d+} in ⁴ /ft	I _{d-} in ⁴ /ft	S _{e+} in ³ /ft	S _{e-} in ³ /ft	M _{n+} k-ft/ft	M _{n-} k-ft/ft	M _{nxt+} k-ft/ft	M _{nxt-} k-ft/ft	V _n k/ft	T _n k/ft
22	0.589	0.698	0.643	0.715	0.345	0.372	1.438	1.550	1.875	2.342	3.481	26.85
20	0.754	0.874	0.806	0.886	0.448	0.476	1.867	1.983	2.275	2.838	6.017	32.60
19	0.915	1.046	0.965	1.052	0.554	0.579	2.308	2.413	2.658	3.308	8.203	38.10
18	1.080	1.196	1.123	1.200	0.660	0.675	2.750	2.813	3.008	3.746	10.556	43.20
16	1.455	1.523	1.479	1.524	0.869	0.885	3.621	3.688	3.788	4.708	14.502	54.55

GRADE 80: F _y = 60 ksi, F _u = 62 ksi												
Gage	I _{e+} in ⁴ /ft	I _{e-} in ⁴ /ft	I _{d+} in ⁴ /ft	I _{d-} in ⁴ /ft	S _{e+} in ³ /ft	S _{e-} in ³ /ft	M _{n+} k-ft/ft	M _{n-} k-ft/ft	M _{nxt+} k-ft/ft	M _{nxt-} k-ft/ft	V _n k/ft	T _n k/ft
22	0.578	0.686	0.635	0.707	0.335	0.346	1.675	1.730	2.250	2.810	3.481	32.22
20	0.735	0.859	0.794	0.876	0.434	0.463	2.170	2.315	2.730	3.405	6.238	39.12
19	0.893	1.028	0.950	1.040	0.536	0.563	2.680	2.815	3.190	3.970	8.986	45.72
18	1.050	1.189	1.103	1.195	0.637	0.659	3.185	3.295	3.610	4.495	11.563	51.84

R	w _{tf}	w _{bf}
in.	in.	in.
0.188	3.328	1.746



Nestable Profiles

3NL-32

Interlocking Profiles

3NI-32,

3PLN-32

GRADE 50

GRADE 80

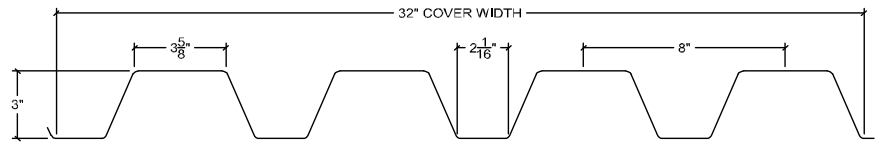

Gage	A_g in ²	x_0 in.	y_0 in.	r_0 in.	j_x in.	C_w in ⁶	J in ⁴	P_{cr1} k	P_{crd} k
22	1.4328	-0.353	0.427	9.546	0.378	198.120	0.000416	15.735	17.058
20	1.7395	-0.352	0.427	9.547	0.377	240.640	0.000743	26.885	25.469
19	2.0318	-0.350	0.428	9.548	0.375	281.220	0.001183	41.568	35.264
18	2.3048	-0.349	0.428	9.549	0.374	319.150	0.001726	59.424	46.159
16	2.9101	-0.346	0.429	9.552	0.371	403.360	0.003469	115.850	75.620

Gage	I_{yg} in ⁴	S_{xt} in ³	S_{xb} in ³	r_x in.	M_{cr1x+} k-in	M_{crdx+} k-in	M_{cr1x-} k-in	M_{crdx-} k-in
22	2.00	1.497	1.201	1.181	19.46	281.59	19.25	17.38
20	2.43	1.814	1.456	1.181	33.08	493.86	77.96	25.97
19	2.84	2.115	1.699	1.182	50.96	604.21	119.55	36.09
18	3.22	2.395	1.925	1.182	72.65	711.60	48.66	47.19
16	4.07	3.012	2.424	1.183	141.90	1212.00	327.90	77.60

Gage	I_{yg} in ⁴	S_{yl} in ³	S_{yr} in ³	r_y in.	M_{crly+} k-in	M_{crdy+} k-in	M_{crly-} k-in	M_{crdy-} k-in
22	128.13	7.728	7.917	9.457	90.76	98.21	101.79	240.40
20	155.60	9.384	9.612	9.458	163.40	135.53	176.95	225.21
19	181.78	10.963	11.229	9.459	256.19	187.77	276.69	507.50
18	206.26	12.438	12.739	9.460	322.99	245.80	398.63	617.48
16	260.55	15.710	16.089	9.462	730.20	402.80	786.20	617.80



Nestable Profiles

3N-24

Interlocking Profiles

3NI-24

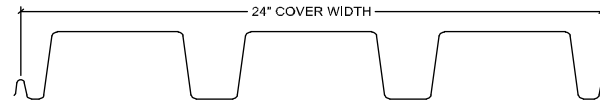
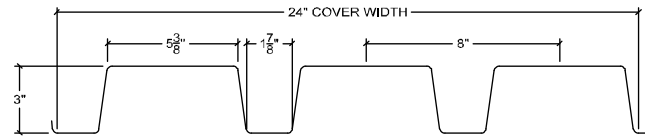

Gage	t in.	w _{dd} psf	A _g in ² /ft	I _{xg} in ⁴ /ft	S _{xb} in ³ /ft	S _{xt} in ³ /ft	y _b in.	y _t in.	r in.	h _w in.	θ deg.
22	0.0295	2.0	0.595	0.882	0.463	0.746	1.907	1.182	1.218	2.731	82.5
20	0.0358	2.5	0.723	1.071	0.561	0.903	1.910	1.186	1.217	2.724	82.6
19	0.0418	2.9	0.845	1.252	0.654	1.053	1.913	1.189	1.217	2.718	82.7
18	0.0474	3.3	0.958	1.420	0.742	1.191	1.915	1.192	1.217	2.711	82.8
16	0.0598	4.1	1.210	1.795	0.934	1.497	1.921	1.199	1.218	2.697	83.0

GRADE 40: F _y = 40 ksi, F _u = 55 ksi												
Gage	I _{e+} in ⁴ /ft	I _{e-} in ⁴ /ft	I _{d+} in ⁴ /ft	I _{d-} in ⁴ /ft	S _{e+} in ³ /ft	S _{e-} in ³ /ft	M _{n+} k-ft/ft	M _{n-} k-ft/ft	M _{nxt+} k-ft/ft	M _{nxt-} k-ft/ft	V _n k/ft	T _n k/ft
22	0.630	0.863	0.714	0.869	0.368	0.419	1.227	1.397	1.543	2.487	3.898	23.80
20	0.816	1.071	0.901	1.071	0.482	0.530	1.607	1.767	1.870	3.010	5.742	28.92
19	1.006	1.252	1.088	1.252	0.584	0.637	1.947	2.123	2.180	3.510	7.830	33.80
18	1.192	1.421	1.268	1.421	0.674	0.731	2.247	2.437	2.473	3.970	9.180	38.32
16	1.625	1.795	1.682	1.795	0.876	0.934	2.920	3.113	3.113	4.990	11.527	48.40

R in.	w _{tr} in.	w _{bf} in.
0.188	4.989	1.489



Nestable Profiles

3N-24

Interlocking Profiles

3NI-24

GRADE 40

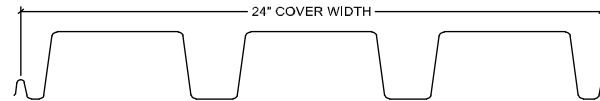
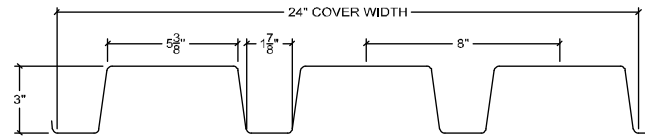

Gage	A_g in ²	x_0 in.	y_0 in.	r_0 in.	j_x in.	C_w in ⁶	J in ⁴	P_{cr1} k	P_{crd} k
22	1.1908	-0.370	0.901	7.370	0.419	106.140	0.000345	5.529	16.591
20	1.4459	-0.369	0.901	7.371	0.418	128.950	0.000618	9.773	24.944
19	1.6892	-0.367	0.902	7.372	0.417	150.720	0.000984	15.445	34.539
18	1.9164	-0.366	0.903	7.372	0.416	171.080	0.001435	22.406	45.138
16	2.4203	-0.364	0.905	7.374	0.413	216.310	0.002885	44.625	74.560

Gage	I_{xg} in ⁴	S_{xt} in ³	S_{xb} in ³	r_x in.	M_{cr1x+} k-in	M_{crdx+} k-in	M_{cr1x-} k-in	M_{crdx-} k-in
22	1.76	1.492	0.925	1.217	6.36	369.92	30.07	15.75
20	2.14	1.807	1.122	1.217	11.25	448.71	52.81	23.66
19	2.50	2.105	1.309	1.218	17.80	523.68	83.11	32.77
18	2.84	2.383	1.484	1.218	25.84	593.60	120.22	42.82
16	3.59	2.996	1.871	1.218	51.52	748.24	238.21	70.71

Gage	I_{yg} in ⁴	S_{y1} in ³	S_{yr} in ³	r_y in.	M_{cr1y+} k-in	M_{crdy+} k-in	M_{cr1y-} k-in	M_{crdy-} k-in
22	61.78	4.959	5.073	7.203	35.89	68.58	34.57	85.87
20	75.04	6.021	6.160	7.204	63.42	103.11	61.14	256.68
19	87.68	7.033	7.197	7.205	100.19	142.78	96.65	179.01
18	99.50	7.978	8.166	7.206	145.33	186.50	140.27	209.09
16	125.72	10.074	10.317	7.207	289.37	308.24	279.54	368.57



Embossed Profiles

2VLI-36, 2PLVLI-36,
2VLJ-36

Non-Embossed Profiles

2C-36

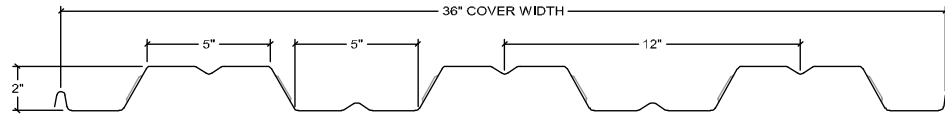

Gage	t in.	w _{dd} psf	A _g in ² /ft	I _{xg} in ⁴ /ft	S _{xb} in ³ /ft	S _{xt} in ³ /ft	y _b in.	y _t in.	r in.	h _w in.	θ deg.	K _{min} -
22	0.0295	1.6	0.458	0.347	0.338	0.326	1.026	1.063	0.870	2.048	63.6	1.000
20	0.0358	1.9	0.556	0.420	0.408	0.394	1.030	1.066	0.869	2.041	63.7	1.000
19	0.0418	2.2	0.649	0.490	0.474	0.458	1.033	1.069	0.869	2.035	63.8	1.000
18	0.0474	2.5	0.736	0.557	0.538	0.520	1.036	1.072	0.870	2.030	63.9	1.000
16	0.0598	3.2	0.929	0.703	0.675	0.652	1.042	1.078	0.870	2.017	64.1	0.872

GRADE 50: F _y = 50 ksi, F _u = 65 ksi												
Gage	I _{e+} in ⁴ /ft	I _{e-} in ⁴ /ft	I _{d+} in ⁴ /ft	I _{d-} in ⁴ /ft	S _{e+} in ³ /ft	S _{e-} in ³ /ft	M _{n+} k-ft/ft	M _{n-} k-ft/ft	M _{nxt+} k-ft/ft	M _{nxt-} k-ft/ft	V _n k/ft	T _n k/ft
22	0.313	0.313	0.324	0.324	0.244	0.255	1.017	1.063	1.408	1.358	2.626	22.90
20	0.403	0.400	0.409	0.407	0.326	0.337	1.358	1.404	1.700	1.642	3.870	27.80
19	0.490	0.487	0.490	0.488	0.409	0.421	1.704	1.754	1.975	1.908	4.581	32.45
18	0.557	0.557	0.557	0.557	0.485	0.500	2.021	2.083	2.242	2.167	5.184	36.80
16	0.703	0.703	0.703	0.703	0.643	0.652	2.679	2.717	2.813	2.717	6.511	46.45

Gage	A _{g_{tf}} in ²	A _{stf} in ²	I _{sptf} in ⁴	A _{gbf} in ²	A _{sbf} in ²	I _{spbf} in ⁴
22	0.146	0.044	0.001	0.146	0.044	0.001
20	0.177	0.053	0.001	0.177	0.053	0.001
19	0.207	0.062	0.001	0.207	0.062	0.001
18	0.235	0.070	0.002	0.235	0.070	0.002
16	0.296	0.088	0.002	0.296	0.088	0.002

b _{otf} in.	b _{ptf} in.	c _{stf} in.	b _{obf} in.	b _{pbf} in.	c _{sbf} in.
4.727	1.739	2.364	4.727	1.739	2.364

R in.	w _{tf} in.	w _{bf} in.
0.188	4.727	4.727



Embossed Profiles

3VLI-36, 3PLVLI-36,
3VLJ-36

Non-Embossed Profiles

3C-36

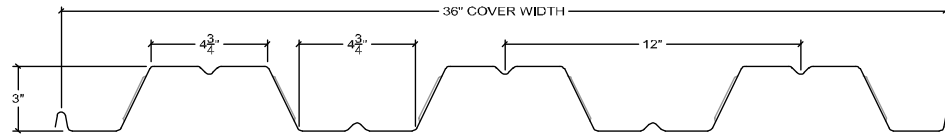

Gage	t in.	w _{dd} psf	A _g in ² /ft	I _{xg} in ⁴ /ft	S _{xb} in ³ /ft	S _{xt} in ³ /ft	y _b in.	y _t in.	r in.	h _w in.	θ deg.	K _{min} -
22	0.0295	1.7	0.502	0.777	0.524	0.503	1.484	1.546	1.244	2.990	67.0	1.000
20	0.0358	2.1	0.610	0.943	0.634	0.609	1.487	1.549	1.243	2.984	67.1	1.000
19	0.0418	2.4	0.712	1.103	0.740	0.711	1.490	1.552	1.245	2.978	67.2	1.000
18	0.0474	2.7	0.808	1.253	0.839	0.806	1.493	1.555	1.245	2.972	67.2	1.000
16	0.0598	3.5	1.020	1.580	1.054	1.012	1.499	1.561	1.245	2.960	67.4	1.000

GRADE 50: F _y = 50 ksi, F _u = 65 ksi												
Gage	I _{e+} in ⁴ /ft	I _{e-} in ⁴ /ft	I _{d+} in ⁴ /ft	I _{d-} in ⁴ /ft	S _{e+} in ³ /ft	S _{e-} in ³ /ft	M _{n+} k-ft/ft	M _{n-} k-ft/ft	M _{nxt+} k-ft/ft	M _{nxt-} k-ft/ft	V _n k/ft	T _n k/ft
22	0.710	0.717	0.732	0.737	0.387	0.410	1.613	1.708	2.183	2.096	2.251	25.10
20	0.907	0.910	0.919	0.921	0.512	0.539	2.133	2.246	2.642	2.538	3.976	30.50
19	1.097	1.100	1.099	1.101	0.639	0.669	2.663	2.788	3.083	2.963	5.423	35.60
18	1.253	1.253	1.253	1.253	0.761	0.794	3.171	3.308	3.496	3.358	6.977	40.40
16	1.580	1.580	1.580	1.580	1.013	1.013	4.221	4.221	4.392	4.217	9.802	51.00

Gage	A _{gtf} in ²	A _{stf} in ²	I _{sptf} in ⁴	A _{gbf} in ²	A _{sbf} in ²	I _{spbf} in ⁴
22	0.140	0.038	0.001	0.140	0.038	0.001
20	0.170	0.046	0.001	0.170	0.046	0.001
19	0.199	0.054	0.001	0.199	0.054	0.001
18	0.225	0.061	0.002	0.225	0.061	0.002
16	0.284	0.078	0.002	0.284	0.078	0.002

b _{otf} in.	b _{ptf} in.	c _{stf} in.	b _{obf} in.	b _{pbf} in.	c _{sbf} in.
4.459	1.729	2.230	4.459	1.729	2.230

R in.	w _{tf} in.	w _{bf} in.
0.188	4.459	4.459



ACOUSTIC

Nestable Profiles

1.5BA-36, 1.5BA-30

Interlocking Profiles

1.5BIA-36, 1.5PLBA-36

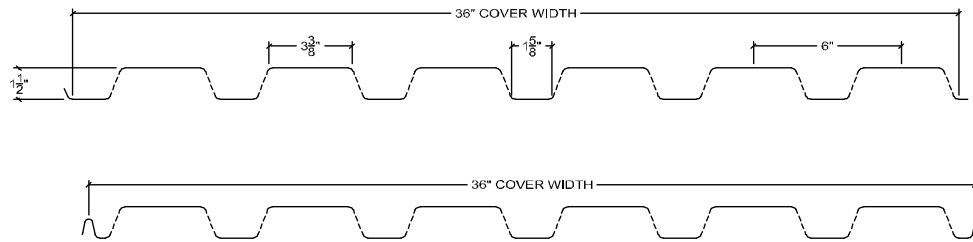

Gage	t in.	w _{dd} psf	A _g in ² /ft	A _n in ² /ft	I _{xg} in ⁴ /ft	S _{xb} in ³ /ft	S _{xt} in ³ /ft	y _b in.	y _t in.	r in.	h _w in.	θ deg.
22	0.0295	1.5	0.478	0.423	0.171	0.191	0.283	0.895	0.605	0.636	1.273	70.5
20	0.0358	1.9	0.580	0.513	0.206	0.229	0.339	0.898	0.608	0.634	1.266	70.7
19	0.0418	2.2	0.678	0.600	0.244	0.271	0.399	0.901	0.611	0.638	1.259	70.9
18	0.0474	2.5	0.769	0.680	0.276	0.305	0.450	0.904	0.614	0.637	1.252	71.1
16	0.0598	3.2	0.971	0.859	0.349	0.384	0.563	0.910	0.620	0.637	1.237	71.4

GRADE 50: F _y = 50 ksi, F _u = 65 ksi												
Gage	I _{e+} in ⁴ /ft	I _{e-} in ⁴ /ft	I _{d+} in ⁴ /ft	I _{d-} in ⁴ /ft	S _{e+} in ³ /ft	S _{e-} in ³ /ft	M _{n+} k-ft/ft	M _{n-} k-ft/ft	M _{nxt+} k-ft/ft	M _{nxt-} k-ft/ft	V _n k/ft	T _n k/ft
22	0.136	0.168	0.148	0.169	0.161	0.170	0.671	0.708	0.796	1.179	3.212	21.15
20	0.177	0.206	0.187	0.206	0.213	0.218	0.888	0.908	0.954	1.413	3.873	25.65
19	0.219	0.244	0.227	0.244	0.253	0.264	1.054	1.100	1.129	1.663	4.494	30.00
18	0.257	0.276	0.263	0.276	0.290	0.302	1.208	1.258	1.271	1.875	5.065	34.00
16	0.345	0.348	0.346	0.348	0.374	0.382	1.558	1.592	1.600	2.346	6.306	42.95

GRADE 80: F _y = 60 ksi, F _u = 62 ksi												
Gage	I _{e+} in ⁴ /ft	I _{e-} in ⁴ /ft	I _{d+} in ⁴ /ft	I _{d-} in ⁴ /ft	S _{e+} in ³ /ft	S _{e-} in ³ /ft	M _{n+} k-ft/ft	M _{n-} k-ft/ft	M _{nxt+} k-ft/ft	M _{nxt-} k-ft/ft	V _n k/ft	T _n k/ft
22	0.130	0.164	0.144	0.166	0.154	0.164	0.770	0.820	0.955	1.415	3.854	25.38
20	0.171	0.206	0.183	0.206	0.204	0.212	1.020	1.060	1.145	1.695	4.647	30.78
19	0.209	0.240	0.221	0.241	0.250	0.257	1.250	1.285	1.355	1.995	5.392	36.00
18	0.250	0.276	0.259	0.276	0.287	0.299	1.435	1.495	1.525	2.250	6.078	40.80

R	w _{tf}	w _{bf}
in.	in.	in.
0.188	3.062	1.325

d _p	c _p	W _p
in.	in.	in.
0.156	0.375	0.906



ACOUSTIC

Nestable Profiles

3NLA-32

Interlocking Profiles

3NIA-32,

3PLNA-32

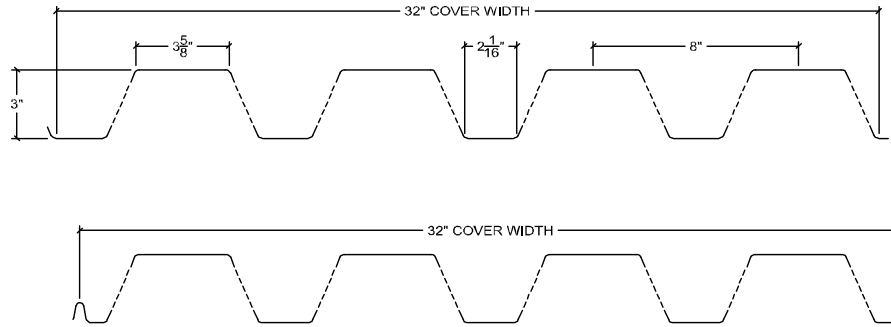

Gage	t in.	w _{dd} psf	A _g in ² /ft	A _n in ² /ft	I _{xg} in ⁴ /ft	S _{xb} in ³ /ft	S _{xt} in ³ /ft	y _b in.	y _t in.	r in.	h _w in.	θ deg.
22	0.0295	1.7	0.537	0.454	0.713	0.428	0.534	1.665	1.335	1.253	2.925	68.2
20	0.0358	2.1	0.652	0.552	0.865	0.519	0.646	1.668	1.338	1.252	2.919	68.3
19	0.0418	2.4	0.762	0.644	1.012	0.606	0.755	1.670	1.341	1.254	2.913	68.3
18	0.0474	2.8	0.864	0.731	1.148	0.686	0.854	1.673	1.344	1.253	2.907	68.4
16	0.0598	3.5	1.091	0.923	1.450	0.864	1.073	1.679	1.351	1.253	2.894	68.6

GRADE 50: F _y = 50 ksi, F _u = 65 ksi												
Gage	I _{e+} in ⁴ /ft	I _{e-} in ⁴ /ft	I _{d+} in ⁴ /ft	I _{d-} in ⁴ /ft	S _{e+} in ³ /ft	S _{e-} in ³ /ft	M _{n+} k-ft/ft	M _{n-} k-ft/ft	M _{nxt+} k-ft/ft	M _{nxt-} k-ft/ft	V _n k/ft	T _n k/ft
22	0.560	0.663	0.611	0.680	0.328	0.353	1.367	1.471	1.783	2.225	2.611	22.70
20	0.716	0.830	0.766	0.842	0.426	0.452	1.775	1.883	2.163	2.692	4.513	27.60
19	0.869	0.994	0.917	1.000	0.526	0.550	2.192	2.292	2.525	3.146	6.152	32.20
18	1.026	1.136	1.067	1.140	0.627	0.641	2.613	2.671	2.858	3.558	7.917	36.55
16	1.382	1.447	1.405	1.448	0.826	0.841	3.442	3.504	3.600	4.471	10.877	46.15

GRADE 80: F _y = 60 ksi, F _u = 62 ksi												
Gage	I _{e+} in ⁴ /ft	I _{e-} in ⁴ /ft	I _{d+} in ⁴ /ft	I _{d-} in ⁴ /ft	S _{e+} in ³ /ft	S _{e-} in ³ /ft	M _{n+} k-ft/ft	M _{n-} k-ft/ft	M _{nxt+} k-ft/ft	M _{nxt-} k-ft/ft	V _n k/ft	T _n k/ft
22	0.549	0.652	0.604	0.672	0.318	0.329	1.590	1.645	2.140	2.670	2.611	27.24
20	0.698	0.816	0.754	0.832	0.412	0.440	2.060	2.200	2.595	3.230	4.679	33.12
19	0.848	0.977	0.903	0.989	0.509	0.535	2.545	2.675	3.030	3.775	6.740	38.64
18	0.998	1.130	1.048	1.136	0.605	0.626	3.025	3.130	3.430	4.270	8.672	43.86

R	w _{tf}	w _{bf}
in.	in.	in.
0.188	3.328	1.746

d _p	c _p	W _p
in.	in.	in.
0.156	0.375	2.031



ACOUSTIC

Nestable Profiles

3NA-24

Interlocking Profiles

3NIA-24

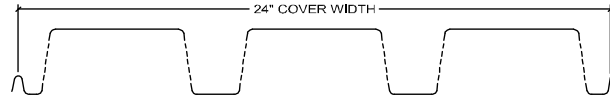
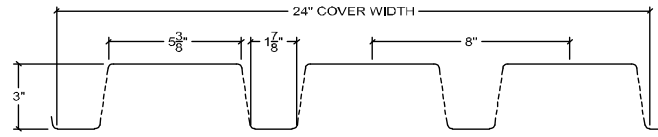

Gage	t in.	w _{dd} psf	A _g in ² /ft	A _n in ² /ft	I _{xg} in ⁴ /ft	S _{xb} in ³ /ft	S _{xt} in ³ /ft	y _b in.	y _t in.	r in.	h _w in.	θ deg.
22	0.0295	1.9	0.595	0.512	0.838	0.439	0.709	1.907	1.182	1.279	2.731	82.5
20	0.0358	2.4	0.723	0.622	1.017	0.532	0.858	1.910	1.186	1.279	2.724	82.6
19	0.0418	2.8	0.845	0.727	1.189	0.622	1.000	1.913	1.189	1.279	2.718	82.7
18	0.0474	3.1	0.958	0.825	1.349	0.704	1.132	1.915	1.192	1.279	2.711	82.8
16	0.0598	3.9	1.210	1.042	1.705	0.888	1.422	1.921	1.199	1.279	2.697	83.0

GRADE 40: F _y = 40 ksi, F _u = 55 ksi												
Gage	I _{e+} in ⁴ /ft	I _{e-} in ⁴ /ft	I _{d+} in ⁴ /ft	I _{d-} in ⁴ /ft	S _{e+} in ³ /ft	S _{e-} in ³ /ft	M _{n+} k-ft/ft	M _{n-} k-ft/ft	M _{nxt+} k-ft/ft	M _{nxt-} k-ft/ft	V _n k/ft	T _n k/ft
22	0.599	0.820	0.679	0.826	0.349	0.398	1.163	1.327	1.463	2.363	2.905	20.48
20	0.775	1.017	0.856	1.017	0.458	0.503	1.527	1.677	1.773	2.860	4.276	24.88
19	0.955	1.189	1.033	1.189	0.555	0.605	1.850	2.017	2.073	3.333	5.826	29.08
18	1.132	1.350	1.204	1.350	0.640	0.695	2.133	2.317	2.347	3.773	6.825	33.00
16	1.544	1.705	1.598	1.705	0.832	0.887	2.773	2.957	2.960	4.740	8.554	41.68

R	w _{tr}	w _{bf}
in.	in.	in.
0.188	4.989	1.489

d _p	c _p	W _p
in.	in.	in.
0.156	0.375	2.031



Nestable Profiles
1.5C-36, 1.5C-30

Nestable Profiles (Embossed)
1.5VLR-36

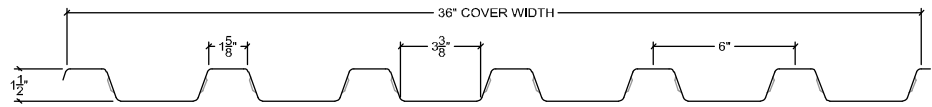

Gage	t in.	w _{dd} psf	A _g in ² /ft	I _{xg} in ⁴ /ft	S _{xb} in ³ /ft	S _{xt} in ³ /ft	y _b in.	y _t in.	r in.	h _w in.	θ deg.	K _{min} -
24	0.0239	1.3	0.387	0.147	0.244	0.165	0.602	0.892	0.616	1.279	70.3	-
22	0.0295	1.6	0.478	0.180	0.298	0.201	0.605	0.895	0.614	1.273	70.5	1.000
20	0.0358	2.0	0.580	0.217	0.357	0.242	0.608	0.898	0.612	1.266	70.7	1.000
18	0.0474	2.6	0.769	0.290	0.472	0.321	0.614	0.904	0.614	1.252	71.1	1.000
16	0.0598	3.3	0.971	0.367	0.592	0.403	0.620	0.910	0.615	1.237	71.4	1.000

GRADE 50: F _y = 50 ksi, F _u = 65 ksi												
Gage	I _{e+} in ⁴ /ft	I _{e-} in ⁴ /ft	I _{d+} in ⁴ /ft	I _{d-} in ⁴ /ft	S _{e+} in ³ /ft	S _{e-} in ³ /ft	M _{n+} k-ft/ft	M _{n-} k-ft/ft	M _{nxt+} k-ft/ft	M _{nxt-} k-ft/ft	V _n k/ft	T _n k/ft
22	0.177	0.143	0.178	0.155	0.179	0.169	0.746	0.704	1.242	0.838	4.247	23.90
20	0.217	0.187	0.217	0.197	0.229	0.224	0.954	0.933	1.488	1.008	5.131	29.00
18	0.290	0.270	0.290	0.277	0.318	0.306	1.325	1.275	1.967	1.338	6.735	38.45
16	0.367	0.363	0.367	0.364	0.402	0.393	1.675	1.638	2.467	1.679	8.417	48.55

GRADE 80: F _y = 60 ksi, F _u = 62 ksi												
Gage	I _{e+} in ⁴ /ft	I _{e-} in ⁴ /ft	I _{d+} in ⁴ /ft	I _{d-} in ⁴ /ft	S _{e+} in ³ /ft	S _{e-} in ³ /ft	M _{n+} k-ft/ft	M _{n-} k-ft/ft	M _{nxt+} k-ft/ft	M _{nxt-} k-ft/ft	V _n k/ft	T _n k/ft
24	0.133	0.103	0.138	0.118	0.131	0.120	0.655	0.600	1.220	0.825	2.481	23.22

R in.	w _{tf} in.	w _{bf} in.
0.188	1.325	3.062



Non-Embossed Profiles

1.3C-32



Gage	t in.	w _{dd} psf	A _g in ² /ft	I _{xg} in ⁴ /ft	S _{xb} in ³ /ft	S _{xt} in ³ /ft	y _b in.	y _t in.	r in.	h _w in.	θ deg.
26	0.0179	0.9	0.278	0.070	0.108	0.100	0.647	0.701	0.502	1.371	47.1
24	0.0239	1.3	0.371	0.093	0.143	0.132	0.650	0.704	0.501	1.365	47.2
22	0.0295	1.6	0.458	0.116	0.178	0.164	0.653	0.707	0.503	1.360	47.3
20	0.0358	1.9	0.556	0.139	0.212	0.196	0.656	0.710	0.500	1.354	47.4

GRADE 80: F _y = 60 ksi, F _u = 62 ksi												
Gage	I _{e+} in ⁴ /ft	I _{e-} in ⁴ /ft	I _{d+} in ⁴ /ft	I _{d-} in ⁴ /ft	S _{e+} in ³ /ft	S _{e-} in ³ /ft	M _{n+} k-ft/ft	M _{n-} k-ft/ft	M _{nxt+} k-ft/ft	M _{nxt-} k-ft/ft	V _n k/ft	T _n k/ft
26	0.065	0.065	0.067	0.067	0.080	0.089	0.400	0.445	0.540	0.500	2.275	16.68
24	0.093	0.092	0.093	0.092	0.126	0.130	0.630	0.650	0.715	0.660	4.060	22.26
22	0.116	0.116	0.116	0.116	0.163	0.163	0.815	0.815	0.890	0.820	5.570	27.48
20	0.139	0.139	0.139	0.139	0.197	0.197	0.985	0.985	1.060	0.980	6.738	33.36

R in.	w _{tf} in.	w _{bf} in.
0.500	0.607	0.607



Non-Embossed Profiles

1.0C-36

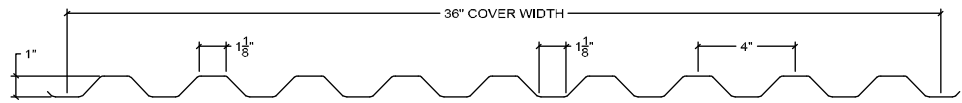

Gage	t in.	w _{dd} psf	A _g in ² /ft	I _{xg} in ⁴ /ft	S _{xb} in ³ /ft	S _{xt} in ³ /ft	y _b in.	y _t in.	r in.	h _w in.	θ deg.
26	0.0179	0.9	0.271	0.042	0.086	0.081	0.486	0.520	0.394	1.146	48.3
24	0.0239	1.2	0.362	0.057	0.117	0.109	0.488	0.523	0.397	1.141	48.4
22	0.0295	1.5	0.447	0.070	0.143	0.133	0.491	0.526	0.396	1.136	48.5
20	0.0358	1.8	0.542	0.083	0.168	0.157	0.494	0.529	0.391	1.130	48.6

GRADE 80: F _y = 60 ksi, F _u = 62 ksi												
Gage	I _{e+} in ⁴ /ft	I _{e-} in ⁴ /ft	I _{d+} in ⁴ /ft	I _{d-} in ⁴ /ft	S _{e+} in ³ /ft	S _{e-} in ³ /ft	M _{n+} k-ft/ft	M _{n-} k-ft/ft	M _{nxt+} k-ft/ft	M _{nxt-} k-ft/ft	V _n k/ft	T _n k/ft
26	0.038	0.038	0.039	0.039	0.065	0.068	0.325	0.340	0.430	0.405	2.650	16.26
24	0.057	0.057	0.057	0.057	0.099	0.103	0.495	0.515	0.585	0.545	4.406	21.72
22	0.070	0.070	0.070	0.070	0.129	0.131	0.645	0.655	0.715	0.665	5.423	26.82
20	0.083	0.083	0.083	0.083	0.160	0.160	0.800	0.800	0.840	0.785	6.560	32.52

R in.	w _{tf} in.	w _{bf} in.
0.188	0.944	0.944



Non-Embossed Profiles

1.0C-33

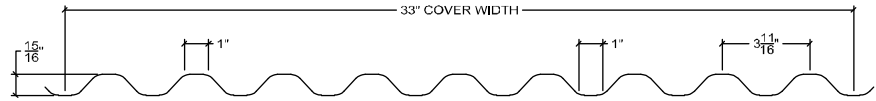

Gage	t in.	w _{dd} psf	A _g in ² /ft	I _{xg} in ⁴ /ft	S _{xb} in ³ /ft	S _{xt} in ³ /ft	y _b in.	y _t in.	r in.	h _w in.	θ deg.
26	0.0179	0.9	0.272	0.037	0.078	0.073	0.472	0.506	0.369	0.807	49.0
24	0.0239	1.2	0.363	0.050	0.105	0.098	0.474	0.509	0.371	0.800	49.2
22	0.0295	1.5	0.448	0.062	0.130	0.121	0.477	0.512	0.372	0.793	49.3
20	0.0358	1.8	0.544	0.076	0.158	0.148	0.480	0.515	0.374	0.785	49.5

GRADE 80: F _y = 60 ksi, F _u = 62 ksi												
Gage	I _{e+} in ⁴ /ft	I _{e-} in ⁴ /ft	I _{d+} in ⁴ /ft	I _{d-} in ⁴ /ft	S _{e+} in ³ /ft	S _{e-} in ³ /ft	M _{n+} k-ft/ft	M _{n-} k-ft/ft	M _{nxt+} k-ft/ft	M _{nxt-} k-ft/ft	V _n k/ft	T _n k/ft
26	0.036	0.035	0.036	0.036	0.065	0.068	0.325	0.340	0.390	0.365	2.570	16.32
24	0.050	0.049	0.050	0.049	0.096	0.097	0.480	0.485	0.525	0.490	3.409	21.78
22	0.062	0.062	0.062	0.062	0.121	0.120	0.605	0.600	0.650	0.605	4.181	26.88
20	0.076	0.076	0.076	0.076	0.147	0.146	0.735	0.730	0.790	0.740	5.037	32.64

R in.	w _{tf} in.	w _{bf} in.
0.500	0.536	0.536



Non-Embossed Profiles

1.0C-32

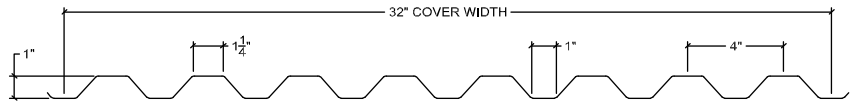

Gage	t in.	w _{dd} psf	A _g in ² /ft	I _{xg} in ⁴ /ft	S _{xb} in ³ /ft	S _{xt} in ³ /ft	y _b in.	y _t in.	r in.	h _w in.	θ deg.
26	0.0179	0.9	0.273	0.044	0.086	0.087	0.514	0.503	0.401	1.203	49.0
24	0.0239	1.2	0.365	0.059	0.114	0.117	0.517	0.506	0.402	1.198	49.1
22	0.0295	1.5	0.450	0.071	0.137	0.139	0.520	0.509	0.397	1.194	49.2
20	0.0358	1.9	0.547	0.090	0.172	0.175	0.523	0.513	0.406	1.188	49.3

GRADE 80: F _y = 60 ksi, F _u = 62 ksi												
Gage	I _{e+} in ⁴ /ft	I _{e-} in ⁴ /ft	I _{d+} in ⁴ /ft	I _{d-} in ⁴ /ft	S _{e+} in ³ /ft	S _{e-} in ³ /ft	M _{n+} k-ft/ft	M _{n-} k-ft/ft	M _{nxt+} k-ft/ft	M _{nxt-} k-ft/ft	V _n k/ft	T _n k/ft
26	0.039	0.042	0.041	0.043	0.067	0.071	0.335	0.355	0.430	0.435	2.676	16.38
24	0.056	0.058	0.057	0.058	0.098	0.103	0.490	0.515	0.570	0.585	4.675	21.90
22	0.071	0.071	0.071	0.071	0.130	0.134	0.650	0.670	0.685	0.695	5.756	27.00
20	0.090	0.090	0.090	0.090	0.168	0.166	0.840	0.830	0.860	0.875	6.965	32.82

R in.	w _{tf} in.	w _{bf} in.
0.125	1.128	0.888



Non-Embossed Profiles

0.6C-35, 0.6C-30

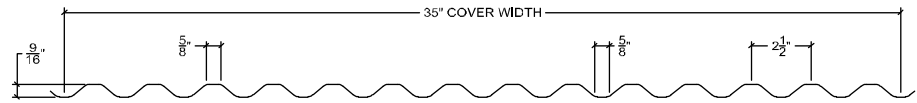

Gage	t in.	w _{dd} psf	A _g in ² /ft	I _{xg} in ⁴ /ft	S _{xb} in ³ /ft	S _{xt} in ³ /ft	y _b in.	y _t in.	r in.	h _w in.	θ deg.
28	0.0149	0.7	0.215	0.011	0.038	0.036	0.290	0.304	0.226	0.609	42.6
26	0.0179	0.9	0.258	0.013	0.045	0.042	0.292	0.306	0.224	0.606	42.7
24	0.0239	1.2	0.345	0.017	0.058	0.055	0.295	0.309	0.222	0.600	42.9
22	0.0295	1.4	0.426	0.021	0.070	0.067	0.298	0.312	0.222	0.595	43.0

GRADE 80: F _y = 60 ksi, F _u = 62 ksi												
Gage	I _{e+} in ⁴ /ft	I _{e-} in ⁴ /ft	I _{d+} in ⁴ /ft	I _{d-} in ⁴ /ft	S _{e+} in ³ /ft	S _{e-} in ³ /ft	M _{n+} k-ft/ft	M _{n-} k-ft/ft	M _{nxt+} k-ft/ft	M _{nxt-} k-ft/ft	V _n k/ft	T _n k/ft
28	0.011	0.011	0.011	0.011	0.033	0.034	0.165	0.170	0.190	0.180	2.122	12.90
26	0.013	0.013	0.013	0.013	0.042	0.042	0.210	0.210	0.225	0.210	2.542	15.48
24	0.017	0.017	0.017	0.017	0.056	0.056	0.280	0.280	0.290	0.275	3.371	20.70
22	0.021	0.021	0.021	0.021	0.069	0.068	0.345	0.340	0.350	0.335	4.134	25.56

R in.	w _{tf} in.	w _{bf} in.
0.310	0.372	0.372



Non-Embossed Profiles

0.6C-36

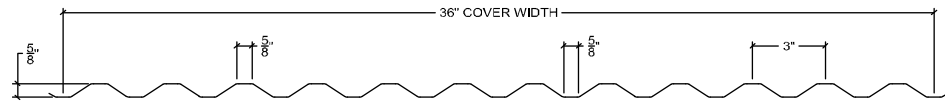

Gage	t in.	w _{dd} psf	A _g in ² /ft	I _{xg} in ⁴ /ft	S _{xb} in ³ /ft	S _{xt} in ³ /ft	y _b in.	y _t in.	r in.	h _w in.	θ deg.
28	0.0149	0.7	0.210	0.012	0.038	0.036	0.317	0.333	0.239	0.960	35.5
26	0.0179	0.9	0.252	0.015	0.047	0.045	0.318	0.334	0.244	0.958	35.6
24	0.0239	1.1	0.337	0.020	0.062	0.059	0.321	0.337	0.244	0.954	35.6
22	0.0295	1.4	0.416	0.023	0.071	0.068	0.324	0.340	0.235	0.950	35.7

GRADE 80: F _y = 60 ksi, F _u = 62 ksi												
Gage	I _{e+} in ⁴ /ft	I _{e-} in ⁴ /ft	I _{d+} in ⁴ /ft	I _{d-} in ⁴ /ft	S _{e+} in ³ /ft	S _{e-} in ³ /ft	M _{n+} k-ft/ft	M _{n-} k-ft/ft	M _{nxt+} k-ft/ft	M _{nxt-} k-ft/ft	V _n k/ft	T _n k/ft
28	0.012	0.012	0.012	0.012	0.034	0.035	0.170	0.175	0.190	0.180	1.905	12.60
26	0.015	0.015	0.015	0.015	0.043	0.043	0.215	0.215	0.235	0.225	2.751	15.12
24	0.020	0.020	0.020	0.020	0.058	0.058	0.290	0.290	0.310	0.295	3.825	20.22
22	0.023	0.023	0.023	0.023	0.071	0.071	0.355	0.355	0.355	0.340	4.709	24.96

R in.	w _{tf} in.	w _{bf} in.
0.200	0.492	0.492



Non-Embossed Profiles

1.5BP-36, 1.5PLBP-36
1.5BP-24, 1.5PLBP-24

Embossed Profiles

1.5VLP-36, 1.5PLVLP-36
1.5VLP-24, 1.5PLVLP-24

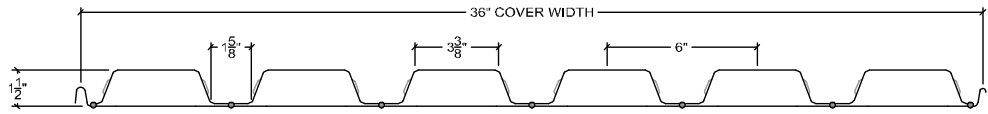

Gage	t in.	t _b in.	w _{dd} psf	A _g in ² /ft	I _{xg} in ⁴ /ft	S _{xb} in ³ /ft	S _{xt} in ³ /ft	y _b in.	y _t in.	r in.	h _w in.	θ deg.	K _{min} -
20/20	0.0358	0.0358	3.5	1.014	0.421	0.757	0.427	0.556	0.986	0.644	1.266	70.7	1.000
20/18	0.0358	0.0474	4.0	1.163	0.460	0.918	0.437	0.501	1.052	0.629	1.266	70.7	1.000
18/20	0.0474	0.0358	4.1	1.196	0.516	0.830	0.554	0.622	0.932	0.657	1.252	71.1	1.000
18/18	0.0474	0.0474	4.6	1.344	0.565	0.995	0.567	0.568	0.996	0.648	1.252	71.1	1.000
18/16	0.0474	0.0598	5.1	1.504	0.610	1.162	0.579	0.525	1.053	0.637	1.252	71.1	1.000
16/18	0.0598	0.0474	5.2	1.539	0.670	1.074	0.703	0.624	0.953	0.660	1.237	71.4	1.000
16/16	0.0598	0.0598	5.8	1.698	0.724	1.244	0.718	0.582	1.008	0.653	1.237	71.4	1.000

GRADE 50: F _y = 50 ksi, F _u = 65 ksi												
Gage	I _{e+} in ⁴ /ft	I _{e-} in ⁴ /ft	I _{d+} in ⁴ /ft	I _{d-} in ⁴ /ft	S _{e+} in ³ /ft	S _{e-} in ³ /ft	M _{n+} k-ft/ft	M _{n-} k-ft/ft	M _{nxt+} k-ft/ft	M _{nxt-} k-ft/ft	V _n k/ft	T _n k/ft
20/20	0.379	0.229	0.393	0.293	0.272	0.240	1.133	1.000	3.154	1.779	5.131	50.70
20/18	0.412	0.243	0.428	0.315	0.280	0.259	1.167	1.079	3.825	1.821	5.131	58.15
18/20	0.498	0.296	0.504	0.369	0.405	0.312	1.688	1.300	3.458	2.308	6.735	59.80
18/18	0.544	0.311	0.551	0.396	0.415	0.330	1.729	1.375	4.146	2.363	6.735	67.20
18/16	0.586	0.330	0.594	0.423	0.425	0.350	1.771	1.458	4.842	2.413	6.735	75.20
16/18	0.666	0.383	0.667	0.479	0.579	0.400	2.413	1.667	4.475	2.929	8.417	76.95
16/16	0.719	0.403	0.721	0.510	0.591	0.421	2.463	1.754	5.183	2.992	8.417	84.90

R	w _{tf}	w _{bf}	w _{bp1}	S _{bp}
in.	in.	in.	in.	in.
0.188	3.062	1.325	6.000	6.000



Non-Embossed Profiles

3NP-32, 3PLNP-32

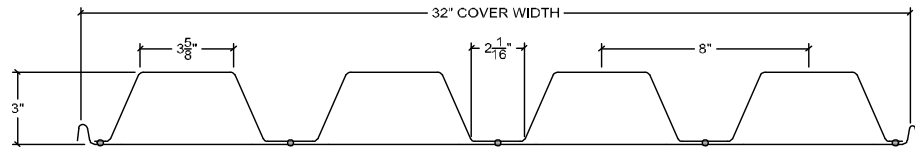

Gage	t in.	t _b in.	w _{dd} psf	A _g in ² /ft	I _{xg} in ⁴ /ft	S _{xb} in ³ /ft	S _{xt} in ³ /ft	y _b in.	y _t in.	r in.	h _w in.	θ deg.
20/20	0.0358	0.0358	3.7	1.087	1.629	1.560	0.816	1.044	1.997	1.224	2.919	68.3
20/18	0.0358	0.0474	4.2	1.237	1.766	1.889	0.833	0.935	2.119	1.195	2.919	68.3
18/20	0.0474	0.0358	4.4	1.291	2.000	1.721	1.058	1.162	1.891	1.245	2.907	68.4
18/18	0.0474	0.0474	4.9	1.440	2.173	2.056	1.082	1.057	2.008	1.228	2.907	68.4
18/16	0.0474	0.0598	5.5	1.601	2.326	2.403	1.103	0.968	2.109	1.205	2.907	68.4
16/18	0.0598	0.0474	5.6	1.658	2.576	2.228	1.341	1.156	1.921	1.246	2.894	68.6
16/16	0.0598	0.0598	6.2	1.819	2.763	2.580	1.368	1.071	2.019	1.232	2.894	68.6

GRADE 50: F _y = 50 ksi, F _u = 65 ksi												
Gage	I _{e+} in ⁴ /ft	I _{e-} in ⁴ /ft	I _{d+} in ⁴ /ft	I _{d-} in ⁴ /ft	S _{e+} in ³ /ft	S _{e-} in ³ /ft	M _{n+} k-ft/ft	M _{n-} k-ft/ft	M _{nxt+} k-ft/ft	M _{nxt-} k-ft/ft	V _n k/ft	T _n k/ft
20/20	1.464	0.915	1.519	1.153	0.496	0.492	2.067	2.050	6.500	3.400	6.017	54.35
20/18	1.585	0.989	1.645	1.248	0.523	0.552	2.179	2.300	7.871	3.471	6.017	61.85
18/20	1.896	1.190	1.931	1.460	0.786	0.674	3.275	2.808	7.171	4.408	10.556	64.55
18/18	2.055	1.266	2.094	1.568	0.806	0.733	3.358	3.054	8.567	4.508	10.556	72.00
18/16	2.202	1.385	2.243	1.699	0.806	0.822	3.358	3.425	10.013	4.596	10.556	80.05
16/18	2.535	1.563	2.549	1.901	1.093	0.901	4.554	3.754	9.283	5.588	14.502	82.90
16/16	2.717	1.688	2.732	2.046	1.116	0.998	4.650	4.158	10.750	5.700	14.502	90.95

R in.	w _{tf} in.	w _{bf} in.	w _{bp1} in.	S _{bp} in.
0.188	3.328	1.746	8.000	6.000



Non-Embossed Profiles

3NP-24, 3PLNP-24

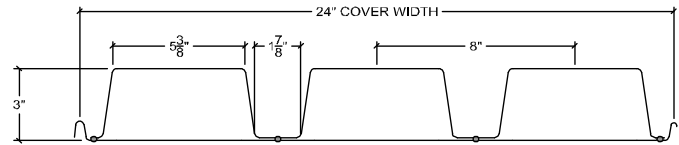

Gage	t in.	t _b in.	w _{dd} psf	A _g in ² /ft	I _{xg} in ⁴ /ft	S _{xb} in ³ /ft	S _{xt} in ³ /ft	y _b in.	y _t in.	r in.	h _w in.	θ deg.
20/20	0.0358	0.0358	3.9	1.159	2.045	1.651	1.080	1.239	1.893	1.328	2.724	82.6
20/18	0.0358	0.0474	4.5	1.312	2.240	2.014	1.103	1.112	2.031	1.307	2.724	82.6
18/20	0.0474	0.0358	4.7	1.383	2.482	1.810	1.401	1.371	1.772	1.340	2.711	82.8
18/18	0.0474	0.0474	5.2	1.536	2.726	2.177	1.432	1.252	1.903	1.332	2.711	82.8
18/16	0.0474	0.0598	5.8	1.701	2.945	2.565	1.459	1.148	2.019	1.316	2.711	82.8
16/18	0.0598	0.0474	6.0	1.776	3.203	2.350	1.775	1.363	1.804	1.343	2.697	83.0
16/16	0.0598	0.0598	6.6	1.941	3.466	2.740	1.810	1.265	1.915	1.336	2.697	83.0

GRADE 40: F _y = 40 ksi, F _u = 55 ksi												
Gage	I _{e+} in ⁴ /ft	I _{e-} in ⁴ /ft	I _{d+} in ⁴ /ft	I _{d-} in ⁴ /ft	S _{e+} in ³ /ft	S _{e-} in ³ /ft	M _{n+} k-ft/ft	M _{n-} k-ft/ft	M _{nxt+} k-ft/ft	M _{nxt-} k-ft/ft	V _n k/ft	T _n k/ft
20/20	1.656	1.111	1.786	1.422	0.574	0.560	1.913	1.867	5.503	3.600	5.742	46.36
20/18	1.807	1.241	1.951	1.574	0.581	0.647	1.937	2.157	6.713	3.677	5.742	52.48
18/20	2.197	1.425	2.292	1.777	0.861	0.712	2.870	2.373	6.033	4.670	9.180	55.32
18/18	2.399	1.560	2.508	1.949	0.882	0.800	2.940	2.667	7.257	4.773	9.180	61.44
18/16	2.577	1.762	2.700	2.156	0.900	0.941	3.000	3.137	8.550	4.863	9.180	68.04
16/18	3.004	1.900	3.070	2.334	1.216	0.961	4.053	3.203	7.833	5.917	11.527	71.04
16/16	3.242	2.115	3.317	2.565	1.241	1.103	4.137	3.677	9.133	6.033	11.527	77.64

R	w _{tf}	w _{bf}	w _{bp1}	S _{bp}
in.	in.	in.	in.	in.
0.188	4.989	1.489	8.000	6.000



EVALUATION REPORT

Number:

0652

Originally Issued: 05/24/2019

Revised: 01/04/2021

Valid Through: 05/31/2021

Page 44 of 50

Embossed Profiles

2VLP-36, 2PLVLP-36

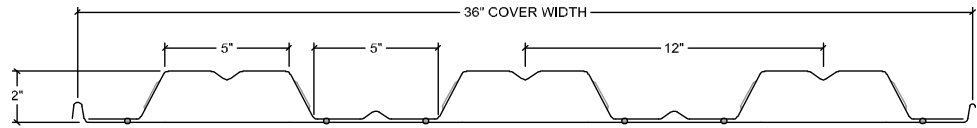

Gage	t in.	t _b in.	w _{dd} psf	A _g in ² /ft	I _{xg} in ⁴ /ft	S _{xb} in ³ /ft	S _{xt} in ³ /ft	y _b in.	y _t in.	r in.	h _w in.	θ deg.	K _{min} -
20/20	0.0358	0.0358	3.3	0.977	0.684	1.116	0.451	0.613	1.518	0.837	2.041	63.7	1.000
20/18	0.0358	0.0474	3.8	1.126	0.730	1.330	0.458	0.549	1.594	0.805	2.041	63.7	1.000
18/20	0.0474	0.0358	3.9	1.147	0.854	1.239	0.587	0.689	1.454	0.863	2.030	63.9	1.000
18/18	0.0474	0.0474	4.4	1.295	0.914	1.460	0.598	0.626	1.529	0.840	2.030	63.9	1.000
18/16	0.0474	0.0598	5.0	1.455	0.967	1.685	0.607	0.574	1.593	0.815	2.030	63.9	1.000
16/18	0.0598	0.0474	5.0	1.476	1.099	1.593	0.744	0.690	1.477	0.863	2.017	64.1	0.872
16/16	0.0598	0.0598	5.6	1.636	1.165	1.823	0.756	0.639	1.541	0.844	2.017	64.1	0.872

GRADE 50: F _y = 50 ksi, F _u = 65 ksi												
Gage	I _{e+} in ⁴ /ft	I _{e-} in ⁴ /ft	I _{d+} in ⁴ /ft	I _{d-} in ⁴ /ft	S _{e+} in ³ /ft	S _{e-} in ³ /ft	M _{n+} k-ft/ft	M _{n-} k-ft/ft	M _{nxt+} k-ft/ft	M _{nxt-} k-ft/ft	V _n k/ft	T _n k/ft
20/20	0.663	0.395	0.670	0.491	0.369	0.303	1.538	1.263	4.650	1.879	3.870	48.85
20/18	0.706	0.424	0.714	0.526	0.378	0.341	1.575	1.421	5.542	1.908	3.870	56.30
18/20	0.854	0.525	0.854	0.635	0.547	0.432	2.279	1.800	5.163	2.446	5.184	57.35
18/18	0.914	0.556	0.914	0.675	0.556	0.469	2.317	1.954	6.083	2.492	5.184	64.75
18/16	0.967	0.591	0.967	0.716	0.565	0.511	2.354	2.129	7.021	2.529	5.184	72.75
16/18	1.099	0.696	1.099	0.830	0.731	0.602	3.046	2.508	6.638	3.100	6.511	73.80
16/16	1.165	0.733	1.165	0.877	0.742	0.643	3.092	2.679	7.596	3.150	6.511	81.80

Gage	A _{gtf} in ²	A _{stf} in ²	I _{sptf} in ⁴	A _{gbf} in ²	A _{sbf} in ²	I _{sptf} in ⁴
20/xx	0.177	0.053	0.001	0.177	0.053	0.001
18/xx	0.235	0.070	0.002	0.235	0.070	0.002
16/xx	0.296	0.088	0.002	0.296	0.088	0.002

b _{otf} in.	b _{ptf} in.	c _{stf} in.	b _{obf} in.	b _{pbf} in.	c _{sbf} in.
4.727	1.739	2.364	4.727	1.739	2.364

R in.	w _{bp1} in.	w _{bp2} in.	s _{bp} in.
0.188	8.000	4.000	6.000



Embossed Profiles

3VLP-36, 3PLVLP-36

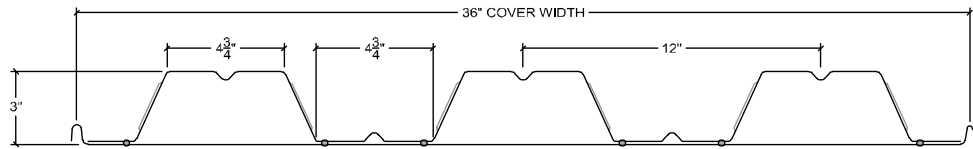

Gage	t in.	t _b in.	w _{dd} psf	A _g in ² /ft	I _{xg} in ⁴ /ft	S _{xb} in ³ /ft	S _{xt} in ³ /ft	y _b in.	y _t in.	r in.	h _w in.	θ deg.	K _{min} -
20/20	0.0358	0.0358	3.5	1.031	1.509	1.662	0.697	0.908	2.164	1.210	2.984	67.1	1.000
20/18	0.0358	0.0474	4.0	1.180	1.611	1.991	0.708	0.809	2.274	1.168	2.984	67.1	1.000
18/20	0.0474	0.0358	4.2	1.218	1.881	1.853	0.910	1.015	2.068	1.243	2.972	67.2	1.000
18/18	0.0474	0.0474	4.7	1.367	2.011	2.186	0.925	0.920	2.175	1.213	2.972	67.2	1.000
18/16	0.0474	0.0598	5.2	1.526	2.127	2.532	0.938	0.840	2.267	1.181	2.972	67.2	1.000
16/18	0.0598	0.0474	5.3	1.567	2.415	2.389	1.152	1.011	2.096	1.241	2.960	67.4	1.000
16/16	0.0598	0.0598	5.9	1.726	2.557	2.741	1.170	0.933	2.186	1.217	2.960	67.4	1.000

GRADE 50: F _y = 50 ksi, F _u = 65 ksi												
Gage	I _{e+} in ⁴ /ft	I _{e-} in ⁴ /ft	I _{d+} in ⁴ /ft	I _{d-} in ⁴ /ft	S _{e+} in ³ /ft	S _{e-} in ³ /ft	M _{n+} k-ft/ft	M _{n-} k-ft/ft	M _{nxt+} k-ft/ft	M _{nxt-} k-ft/ft	V _n k/ft	T _n k/ft
20/20	1.481	0.869	1.490	1.082	0.545	0.465	2.271	1.938	6.925	2.904	3.976	51.55
20/18	1.557	0.922	1.575	1.152	0.573	0.512	2.388	2.133	8.296	2.950	3.976	59.00
18/20	1.881	1.157	1.881	1.398	0.860	0.670	3.583	2.792	7.721	3.792	6.977	60.90
18/18	2.011	1.210	2.011	1.477	0.871	0.715	3.629	2.979	9.108	3.854	6.977	68.35
18/16	2.127	1.305	2.127	1.579	0.869	0.798	3.621	3.325	10.550	3.908	6.977	76.30
16/18	2.415	1.522	2.415	1.820	1.152	0.917	4.800	3.821	9.954	4.800	9.802	78.35
16/16	2.557	1.619	2.557	1.932	1.169	1.002	4.871	4.175	11.421	4.875	9.802	86.30

Gage	A _{gtf} in ²	A _{stf} in ²	I _{sptf} in ⁴	A _{gbf} in ²	A _{sbf} in ²	I _{sptf} in ⁴
20/xx	0.170	0.046	0.001	0.170	0.046	0.001
18/xx	0.225	0.061	0.002	0.225	0.061	0.002
16/xx	0.284	0.078	0.002	0.284	0.078	0.002

b _{otf} in.	b _{ptf} in.	c _{stf} in.	b _{obf} in.	b _{pbf} in.	c _{sbf} in.
4.459	1.729	2.230	4.459	1.729	2.230

R in.	w _{bp1} in.	w _{bp2} in.	s _{bp} in.
0.188	8.000	4.000	6.000



Non-Embossed Profiles

1.5BPA-36, 1.5PLBPA-36
1.5BPA-24, 1.5PLBPA-24

Embossed Profiles

1.5VLPA-36, 1.5PLVLPA-36
1.5VLPA-24, 1.5PLVLPA-24

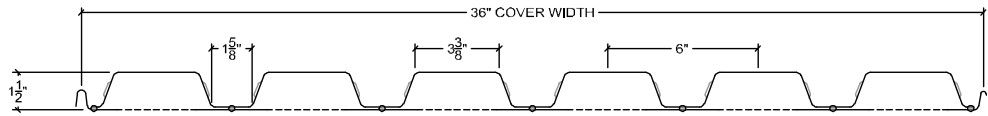

Gage	t in.	t _b in.	w _{dd} psf	A _g in ² /ft	A _n in ² /ft	I _{xg} in ⁴ /ft	S _{xb} in ³ /ft	S _{xt} in ³ /ft	y _b in.	y _t in.	r in.	h _w in.	θ deg.	K _{min} -
20/20	0.0358	0.0358	3.3	1.014	0.979	0.421	0.756	0.427	0.557	0.985	0.656	1.266	70.7	1.000
20/18	0.0358	0.0474	3.8	1.163	1.116	0.459	0.914	0.437	0.502	1.051	0.641	1.266	70.7	1.000
18/20	0.0474	0.0358	4.0	1.196	1.160	0.516	0.830	0.554	0.622	0.931	0.667	1.252	71.1	1.000
18/18	0.0474	0.0474	4.4	1.344	1.297	0.564	0.991	0.567	0.569	0.995	0.659	1.252	71.1	1.000
18/16	0.0474	0.0598	4.9	1.504	1.444	0.609	1.158	0.579	0.526	1.051	0.649	1.252	71.1	1.000
16/18	0.0598	0.0474	5.1	1.539	1.492	0.669	1.070	0.703	0.625	0.952	0.670	1.237	71.4	1.000
16/16	0.0598	0.0598	5.6	1.698	1.639	0.723	1.240	0.718	0.583	1.007	0.664	1.237	71.4	1.000

GRADE 50: F _y = 50 ksi, F _u = 65 ksi												
Gage	I _{e+} in ⁴ /ft	I _{e-} in ⁴ /ft	I _{d+} in ⁴ /ft	I _{d-} in ⁴ /ft	S _{e+} in ³ /ft	S _{e-} in ³ /ft	M _{n+} k-ft/ft	M _{n-} k-ft/ft	M _{nxt+} k-ft/ft	M _{nxt-} k-ft/ft	V _n k/ft	T _n k/ft
20/20	0.359	0.229	0.380	0.293	0.270	0.240	1.125	1.000	3.150	1.779	5.131	48.95
20/18	0.391	0.243	0.414	0.315	0.277	0.259	1.154	1.079	3.808	1.821	5.131	55.80
18/20	0.470	0.296	0.485	0.369	0.400	0.312	1.667	1.300	3.458	2.308	6.735	58.00
18/18	0.513	0.311	0.530	0.395	0.411	0.330	1.713	1.375	4.129	2.363	6.735	64.85
18/16	0.554	0.306	0.572	0.407	0.420	0.311	1.750	1.296	4.825	2.413	6.735	72.20
16/18	0.627	0.383	0.641	0.478	0.571	0.400	2.379	1.667	4.458	2.929	8.417	74.60
16/16	0.677	0.377	0.692	0.492	0.583	0.380	2.429	1.583	5.167	2.992	8.417	81.95

R	w _{tf}	w _{bf}	w _{bp1}	S _{bp}
in.	in.	in.	in.	in.
0.188	3.062	1.325	6.000	6.000

d _p	c _p	P _p
in.	in.	in.
0.156	0.375	3.156



Non-Embossed Profiles
3NPA-32, 3PLNPA-32

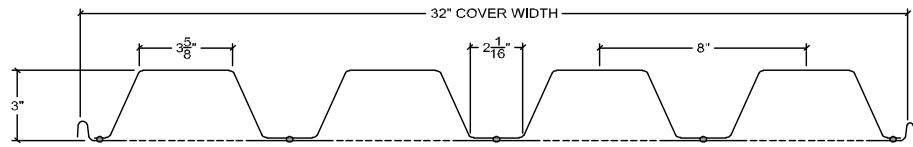

Gage	t in.	t _b in.	w _{dd} psf	A _g in ² /ft	A _n in ² /ft	I _{xg} in ⁴ /ft	S _{xb} in ³ /ft	S _{xt} in ³ /ft	y _b in.	y _t in.	r in.	h _w in.	θ deg.
20/20	0.0358	0.0358	3.6	1.087	1.045	1.627	1.555	0.815	1.046	1.996	1.248	2.919	68.3
20/18	0.0358	0.0474	4.0	1.237	1.181	1.764	1.885	0.833	0.936	2.117	1.222	2.919	68.3
18/20	0.0474	0.0358	4.3	1.291	1.248	1.998	1.718	1.057	1.163	1.890	1.265	2.907	68.4
18/18	0.0474	0.0474	4.7	1.440	1.384	2.170	2.049	1.082	1.059	2.006	1.252	2.907	68.4
18/16	0.0474	0.0598	5.2	1.601	1.530	2.322	2.394	1.102	0.970	2.107	1.232	2.907	68.4
16/18	0.0598	0.0474	5.5	1.658	1.602	2.573	2.222	1.341	1.158	1.919	1.267	2.894	68.6
16/16	0.0598	0.0598	6.0	1.819	1.748	2.758	2.570	1.367	1.073	2.017	1.256	2.894	68.6

GRADE 50: F _y = 50 ksi, F _u = 65 ksi												
Gage	I _{e+} in ⁴ /ft	I _{e-} in ⁴ /ft	I _{d+} in ⁴ /ft	I _{d-} in ⁴ /ft	S _{e+} in ³ /ft	S _{e-} in ³ /ft	M _{n+} k-ft/ft	M _{n-} k-ft/ft	M _{nxt+} k-ft/ft	M _{nxt-} k-ft/ft	V _n k/ft	T _n k/ft
20/20	1.374	0.915	1.458	1.152	0.491	0.492	2.046	2.050	6.479	3.396	6.017	52.25
20/18	1.485	0.989	1.578	1.247	0.504	0.552	2.100	2.300	7.854	3.471	6.017	59.05
18/20	1.778	1.190	1.851	1.459	0.775	0.674	3.229	2.808	7.158	4.404	10.556	62.40
18/18	1.926	1.266	2.007	1.567	0.795	0.733	3.313	3.054	8.538	4.508	10.556	69.20
18/16	2.065	1.293	2.151	1.636	0.797	0.745	3.321	3.104	9.975	4.592	10.556	76.50
16/18	2.372	1.563	2.439	1.900	1.078	0.901	4.492	3.754	9.258	5.588	14.502	80.10
16/16	2.541	1.591	2.613	1.980	1.101	0.908	4.588	3.783	10.708	5.696	14.502	87.40

R	w _{tf}	w _{bf}	w _{bp1}	S _{bp}
in.	in.	in.	in.	in.
0.188	3.328	1.746	8.000	6.000

d _p	c _p	P _p
in.	in.	in.
0.156	0.375	5.031



Non-Embossed Profiles

3NPA-24, 3PLNPA-24

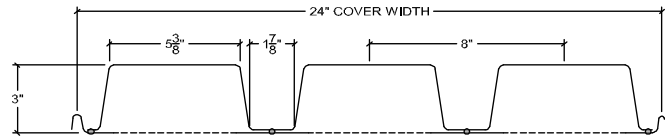

Gage	t in.	t _b in.	w _{dd} psf	A _g in ² /ft	A _n in ² /ft	I _{xg} in ⁴ /ft	S _{xb} in ³ /ft	S _{xt} in ³ /ft	y _b in.	y _t in.	r in.	h _w in.	θ deg.
20/20	0.0358	0.0358	3.8	1.159	1.116	2.042	1.647	1.080	1.240	1.891	1.353	2.724	82.6
20/18	0.0358	0.0474	4.3	1.312	1.256	2.237	2.008	1.103	1.114	2.029	1.335	2.724	82.6
18/20	0.0474	0.0358	4.6	1.383	1.341	2.479	1.806	1.401	1.373	1.770	1.360	2.711	82.8
18/18	0.0474	0.0474	5.0	1.536	1.480	2.722	2.171	1.432	1.254	1.901	1.356	2.711	82.8
18/16	0.0474	0.0598	5.6	1.701	1.630	2.939	2.553	1.458	1.151	2.016	1.343	2.711	82.8
16/18	0.0598	0.0474	5.9	1.776	1.720	3.198	2.343	1.775	1.365	1.802	1.364	2.697	83.0
16/16	0.0598	0.0598	6.4	1.941	1.870	3.459	2.728	1.809	1.268	1.912	1.360	2.697	83.0

GRADE 40: F _y = 40 ksi, F _u = 55 ksi												
Gage	I _{e+} in ⁴ /ft	I _{e-} in ⁴ /ft	I _{d+} in ⁴ /ft	I _{d-} in ⁴ /ft	S _{e+} in ³ /ft	S _{e-} in ³ /ft	M _{n+} k-ft/ft	M _{n-} k-ft/ft	M _{nxt+} k-ft/ft	M _{nxt-} k-ft/ft	V _n k/ft	T _n k/ft
20/20	1.549	1.111	1.713	1.421	0.568	0.560	1.893	1.867	5.490	3.600	5.742	44.64
20/18	1.694	1.239	1.875	1.572	0.564	0.644	1.880	2.147	6.693	3.677	5.742	50.24
18/20	2.050	1.430	2.193	1.780	0.849	0.716	2.830	2.387	6.020	4.670	9.180	53.64
18/18	2.238	1.560	2.399	1.947	0.870	0.800	2.900	2.667	7.237	4.773	9.180	59.20
18/16	2.408	1.602	2.585	2.048	0.888	0.806	2.960	2.687	8.510	4.860	9.180	65.20
16/18	2.794	1.900	2.929	2.333	1.199	0.961	3.997	3.203	7.810	5.917	11.527	68.80
16/16	3.015	1.942	3.163	2.448	1.224	0.964	4.080	3.213	9.093	6.030	11.527	74.80

R	w _{tf}	w _{bf}	w _{bp1}	S _{bp}
in.	in.	in.	in.	in.
0.188	4.989	1.489	8.000	6.000

d _p	c _p	P _p
in.	in.	in.
0.156	0.375	5.031



Embossed Profiles

2VLP-36, 2PLVLP-36

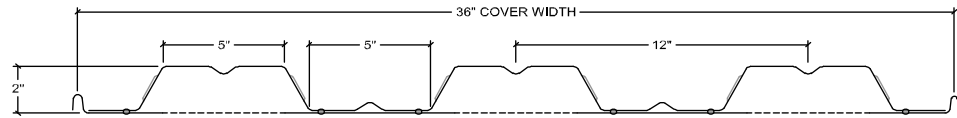

Gage	t	t _b	w _{dd}	A _g	A _n	I _{xg}	S _{xb}	S _{xt}	y _b	y _t	r	h _w	θ	K _{min}
	in.	in.	psf	in ² /ft	in ² /ft	in ⁴ /ft	in ³ /ft	in ³ /ft	in.	in.	in.	in.	deg.	-
20/20	0.0358	0.0358	3.2	0.977	0.949	0.683	1.112	0.450	0.614	1.518	0.848	2.041	63.7	1.000
20/18	0.0358	0.0474	3.7	1.126	1.089	0.730	1.327	0.458	0.550	1.594	0.819	2.041	63.7	1.000
18/20	0.0474	0.0358	3.8	1.147	1.118	0.853	1.236	0.587	0.690	1.454	0.873	2.030	63.9	1.000
18/18	0.0474	0.0474	4.3	1.295	1.258	0.913	1.456	0.598	0.627	1.528	0.852	2.030	63.9	1.000
18/16	0.0474	0.0598	4.8	1.455	1.407	0.966	1.680	0.607	0.575	1.592	0.829	2.030	63.9	1.000
16/18	0.0598	0.0474	4.9	1.476	1.439	1.098	1.589	0.744	0.691	1.476	0.874	2.017	64.1	0.872
16/16	0.0598	0.0598	5.4	1.636	1.588	1.164	1.819	0.756	0.640	1.540	0.856	2.017	64.1	0.872

GRADE 50: F _y = 50 ksi, F _u = 65 ksi												
Gage	I _{e+}	I _{e-}	I _{d+}	I _{d-}	S _{e+}	S _{e-}	M _{n+}	M _{n-}	M _{nxt+}	M _{nxt-}	V _n	T _n
	in ⁴ /ft	in ⁴ /ft	in ⁴ /ft	in ⁴ /ft	in ³ /ft	in ³ /ft	k-ft/ft	k-ft/ft	k-ft/ft	k-ft/ft	k/ft	k/ft
20/20	0.641	0.395	0.655	0.491	0.367	0.303	1.529	1.263	4.633	1.875	3.870	47.45
20/18	0.684	0.424	0.699	0.526	0.376	0.341	1.567	1.421	5.529	1.908	3.870	54.45
18/20	0.824	0.525	0.834	0.634	0.543	0.432	2.263	1.800	5.150	2.446	5.184	55.90
18/18	0.882	0.556	0.892	0.675	0.553	0.469	2.304	1.954	6.067	2.492	5.184	62.90
18/16	0.934	0.591	0.945	0.716	0.562	0.511	2.342	2.129	7.000	2.529	5.184	70.35
16/18	1.061	0.696	1.073	0.830	0.726	0.602	3.025	2.508	6.621	3.100	6.511	71.95
16/16	1.124	0.733	1.137	0.877	0.737	0.643	3.071	2.679	7.579	3.150	6.511	79.40

Gage	A _{gtf}	A _{stf}	I _{sptf}	A _{gbf}	A _{sbf}	I _{sptf}
	in ²	in ²	in ⁴	in ²	in ²	in ⁴
20/xx	0.177	0.053	0.001	0.177	0.053	0.001
18/xx	0.235	0.070	0.002	0.235	0.070	0.002
16/xx	0.296	0.088	0.002	0.296	0.088	0.002

b _{otf}	b _{ptf}	c _{stf}	b _{obf}	b _{pbf}	c _{sbf}
in.	in.	in.	in.	in.	in.
4.727	1.739	2.364	4.727	1.739	2.364

R	w _{bp1}	w _{bp2}	s _{bp}
in.	in.	in.	in.
0.188	8.000	4.000	6.000

d _p	c _p	P _p
in.	in.	in.
0.156	0.375	5.031



Embossed Profiles

3VLPA-36, 3PLVLP-36

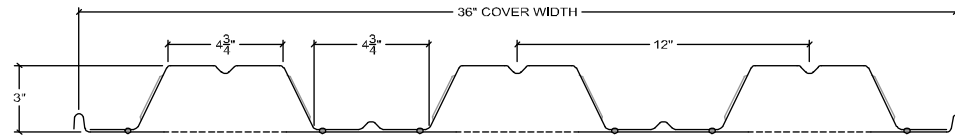

Gage	t in.	t _b in.	w _{dd} psf	A _g in ² /ft	A _n in ² /ft	I _{xg} in ⁴ /ft	S _{xb} in ³ /ft	S _{xt} in ³ /ft	y _b in.	y _t in.	r in.	h _w in.	θ deg.	K _{min} -
20/20	0.0358	0.0358	3.4	1.031	1.003	1.508	1.661	0.697	0.908	2.163	1.226	2.984	67.1	1.000
20/18	0.0358	0.0474	3.9	1.180	1.143	1.610	1.985	0.708	0.811	2.273	1.187	2.984	67.1	1.000
18/20	0.0474	0.0358	4.1	1.218	1.190	1.880	1.850	0.910	1.016	2.067	1.257	2.972	67.2	1.000
18/18	0.0474	0.0474	4.5	1.367	1.329	2.010	2.182	0.925	0.921	2.174	1.230	2.972	67.2	1.000
18/16	0.0474	0.0598	5.0	1.526	1.479	2.125	2.524	0.938	0.842	2.265	1.199	2.972	67.2	1.000
16/18	0.0598	0.0474	5.2	1.567	1.529	2.413	2.384	1.152	1.012	2.095	1.256	2.960	67.4	1.000
16/16	0.0598	0.0598	5.7	1.726	1.679	2.554	2.732	1.169	0.935	2.185	1.233	2.960	67.4	1.000

GRADE 50: F _y = 50 ksi, F _u = 65 ksi												
Gage	I _{e+} in ⁴ /ft	I _{e-} in ⁴ /ft	I _{d+} in ⁴ /ft	I _{d-} in ⁴ /ft	S _{e+} in ³ /ft	S _{e-} in ³ /ft	M _{n+} k-ft/ft	M _{n-} k-ft/ft	M _{nxt+} k-ft/ft	M _{nxt-} k-ft/ft	V _n k/ft	T _n k/ft
20/20	1.432	0.869	1.457	1.082	0.543	0.465	2.263	1.938	6.921	2.904	3.976	50.15
20/18	1.508	0.922	1.542	1.151	0.571	0.512	2.379	2.133	8.271	2.950	3.976	57.15
18/20	1.816	1.157	1.837	1.398	0.853	0.670	3.554	2.792	7.708	3.792	6.977	59.50
18/18	1.942	1.210	1.965	1.477	0.866	0.715	3.608	2.979	9.092	3.854	6.977	66.45
18/16	2.055	1.305	2.078	1.578	0.864	0.798	3.600	3.325	10.517	3.908	6.977	73.95
16/18	2.332	1.522	2.359	1.819	1.142	0.917	4.758	3.821	9.933	4.800	9.802	76.45
16/16	2.467	1.619	2.496	1.931	1.159	1.002	4.829	4.175	11.383	4.871	9.802	83.95

Gage	A _{gtf} in ²	A _{stf} in ²	I _{sptf} in ⁴	A _{gbf} in ²	A _{sbf} in ²	I _{sptf} in ⁴
20/xx	0.170	0.046	0.001	0.170	0.046	0.001
18/xx	0.225	0.061	0.002	0.225	0.061	0.002
16/xx	0.284	0.078	0.002	0.284	0.078	0.002

b _{otf} in.	b _{ptf} in.	c _{stf} in.	b _{obf} in.	b _{pbf} in.	c _{sbf} in.
4.459	1.729	2.230	4.459	1.729	2.230

R in.	w _{bp1} in.	w _{bp2} in.	s _{bp} in.
0.188	8.000	4.000	6.000

d _p in.	c _p in.	P _p in.
0.156	0.375	5.031