

VULCRAFT®

STEEL ROOF & FLOOR DECK



Better Partners. Better Products.
Better Outcomes.™

AUGUST 2018

PLANT INFORMATION

Vulcraft Alabama

7205 Gault Ave. N
Fort Payne, AL 35967
256-845-2460

Vulcraft Indiana

6610 County Road 60
St. Joe, IN 46875
260-337-1800

Vulcraft Nebraska

1601 West Omaha Ave.
Norfolk, NE 68701
402-644-8500

Vulcraft of New York

621 Main Street
Chemung, NY 14825
607-529-9000

Vulcraft South Carolina

1501 West Darlington Street
Florence, SC 29501
843-662-0381

Vulcraft Texas

175 County Road 2345
Grapeland, TX 75844
936-687-4665

Vulcraft Utah (Joist Only)

1875 West Highway 13 South
Brigham City, UT 84302
435-734-9433



TABLE OF CONTENTS

General Product Information.....	4	Non-Composite Slab Design.....	36
Finishes.....	4	Venting.....	36
Product Offer.....	5	Reinforced Concrete Load Tables.....	37
Dovetail Deck.....	6	Fire Resistance Ratings with Non-Composite (Form) Deck.....	40
Cellular & Acoustic Deck.....	7	Non-Composite & Composite Deck Construction Loading.....	41
LEED Information.....	9	Web Crippling Example.....	42
PunchLok® II System.....	10	Non-Composite & Composite Deck Web Crippling Data.....	43
ROOF DECK		Non-Composite & Composite Deck Pour Stop Table.....	44
1.5B/1.5BI/1.5BA/1.5BIA.....	12	Non-Composite & Composite Deck Details.....	45
3N/3NI/3NA/3NIA.....	13	COMPOSITE FLOOR DECK	
1.5F.....	14	1.5VL / 1.5VLI.....	46
1.5A.....	15	1.5VLR.....	48
2.0D.....	16	2VLI.....	50
3.5D.....	17	3VLI.....	52
1.0E.....	18	Fire Resistance Ratings with Composite Deck	54
Fire Resistance Ratings with Roof Deck.....	19	DIAPHRAGM	
Roof Deck Web Crippling Data.....	20	Diaphragm Design.....	57
Roof Deck Accessories.....	22	Typical Fastener Layout.....	61
FM Global.....	23	0.6C, 1.0C, 1.3C.....	62
NON-COMPOSITE FLOOR DECK		1.5VL, 1.5VLI, 2C, 2VLI, 3C, 3VLI.....	68
0.6C/0.6CSV.....	24		
1.0C/1.0CSV.....	26		
1.3C/1.3CSV.....	28		
1.5C.....	30		
2C.....	32		
3C.....	34		

VULCRAFT reserves the right to change the design or details of its products without notice. The information in this catalog is presented for general information only and is not to be used or relied upon for any application without complete review of the proposed application and without a complete review by a licensed professional architect, engineer, designer or other qualified professional.

VULCRAFT assumes no liability whatsoever for the accuracy or completeness of the information contained herein.

VULCRAFT makes no representation or warranty of any kind, either express or implied, respecting any information contained in this catalog including, but not limited to, the accuracy, completeness or suitability of such information for any particular purpose or use.

In addition, VULCRAFT expressly disclaims any liability for incidental, special, consequential or punitive damages including, but not limited to, loss of profits or loss of use arising out of this catalog or its use.

VULCRAFT'S liability, warranties and other obligations with respect to its products are set forth in the Terms and Conditions of Sale provided to Buyer in connection with the provision of such products.

As used herein, references to VULCRAFT include its parents, affiliates and subsidiaries.

The PunchLok II Tool and the method of using it are the subject of U.S. Patent No. 6,212,932, U.S. Patent No. 6,397,469 and/or U.S. Patent No. 8,667,656.

VULCRAFT® and NUCOR® are registered trademarks of Nucor Corporation. VERCO® and PUNCHLOK® are registered trademarks of Verco Decking, Inc. BETTER PARTNERS. BETTER PRODUCTS. BETTER OUTCOMES.TM, PLBTM, PLNTM, VLTM, VLITM and VLRTM are trademarks of Nucor Corporation or its affiliates. All other names may be trademarks of their respective owners. All rights reserved.

VULCRAFT STEEL ROOF & FLOOR DECK

VULCRAFT, a leader in the steel joist and joist girder industry offers a complete range of steel decking at six strategically located deck manufacturing facilities. The deck is accurately roll formed in varying configurations on the most modern high-speed roll forming equipment available.

Steel roof and floor decks have long been recognized for their economy because of their light weight and high strength-to-weight ratio. They provide a durable and attractive roof or floor system for fast all-weather construction. Steel decks also provide excellent lateral diaphragm action thus reducing the necessity for structural bracing and their incombustible nature assures architects, engineers and owners of excellent fire ratings.

ROOF DECK

Vulcraft roof decks are designed in accordance with the ANSI / Steel Deck Institute “RD1.0-2006 Standard for Steel Roof Deck” in conformance with the 2015 IBC. SDI RD1.0-2006 Standard available at: <http://www.vulcraft.com/decks>

Roof Deck Profiles: 1.5B, 1.5BI, 1.5PLB, 1.5F, 1.5A, 3N, 3NI, 3PLN, 1.0E, 2.0D, 3.5D

Acoustical Roof Deck Profiles: 1.5BA, 1.5BIA, 3NA, 3NIA, 2.0DA, 3.5DA

NON-COMPOSITE FLOOR DECK

Vulcraft non-composite (form) decks are designed in accordance with the ANSI / Steel Deck Institute “NC1.0-2006 Standard for Non-Composite Steel Floor Deck” in conformance with the 2015 IBC.

SDI NC1.0-2006 Standard available at: <http://www.vulcraft.com/decks>

Non-Composite Floor Deck Profiles: 0.6C, 0.6CSV, 1.0C, 1.0CSV, 1.3C, 1.3CSV, 1.5C, 2C, 3C

COMPOSITE FLOOR DECK

Vulcraft composite floor decks are designed in accordance with the ANSI / Steel Deck Institute “C-2011 Standard for Composite Steel Floor Deck-Slabs” in conformance with the 2015 IBC.

SDI C-2011 Standard available at: <http://www.vulcraft.com/decks>

Composite Floor Deck Profiles: 1.5VL, 1.5VLI, 1.5VLR, 2VLI, 3VLI

DIAPHRAGM

The Diaphragm Shear Strength and Stiffness tables in this catalog are based on the Third Edition of the Diaphragm Manual (published by the Steel Deck Institute).

MATERIAL

Galvanized fluted decks are formed from either ASTM A653 or A1063 steel. Painted/painted or mill finished (black) uncoated fluted roof decks are formed from either ASTM A1008 or A1039 steel.

Cellular deck sections are fabricated from galvanized steel conforming to ASTM A653 or A1063.

FINISHES









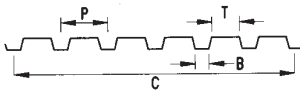



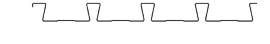

Vulcraft offers a selection of finishes: primer painted over cold-rolled or galvanized, galvanized, or black (uncoated).

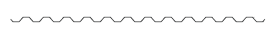
Primer painted: Prior to applying a baked-on acrylic medium gray or white primer, the cold-rolled or galvanized sheet is chemically cleaned and pre-treated.

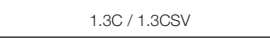
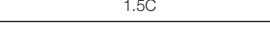
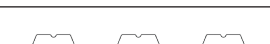
Galvanized: Galvanized decks are supplied from mill coated sheets and are offered in two zinc coated finishes. Coating designation G60 is the standard galvanized material of the deck industry. Coating designation G90 is a heavier, zinc coating often specified for exposed exterior applications or other project specific requirements. Other ASTM A653 galvanized coatings may be available on special request – contact your Vulcraft representative regarding availability.

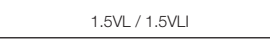
PRODUCT OFFER INFORMATION



		Approximate Dimensions in inches																					
		Indiana				Nebraska				South Carolina				Texas				Alabama / New York					
Deck Type	Gage	C	P	T	B	C	P	T	B	C	P	T	B	C	P	T	B	C	P	T	B		
ROOF DECK	 1.5B / 1.5BI / 1.5BA / 1.5BIA	24 22 20 19 18 16	NA 36 36 36 36 36 36	6.00	3.50	1.75	30 36 36 36 36 36	6.00	3.50	1.75	36 36 36 36 36 36	6.00	3.50	1.75	NA 36 36 36 36 36	6.00	3.50	1.75	36 36 36 36 36 36	6.00	3.50	1.75	1.75
	 3N / 3NI / 3NA / 3NIA	22 20 19 18 16	24	8.00	5.38	1.88	24	8.00	5.38	1.88	24	8.00	5.38	1.88	24	8.00	5.38	1.88	24	8.00	5.38	1.88	1.88
	 1.5F	22 20 19 18	30	6.00	4.25	0.50	36	6.00	4.25	0.50	36	6.00	4.25	0.50	36	6.00	4.25	0.50	36	6.00	4.25	0.50	0.50
	 1.5A	22 20 19 18	36	6.00	5.00	0.38	36	6.00	5.00	0.38	36	6.00	5.00	0.38	NA	---	---	---	NA	---	---	---	---
	 1.0E	26 24 22 20	36	4.00	1.13	1.13	32	4.00	1.25	1.01	33	3.67	0.90	0.90	33	3.67	1.00	1.00	36	4.00	1.13	1.13	1.13
DOVETAIL DECK	 2.0D / 2.0DA	22 20 19 18 16	NA	---	---	---	NA	---	---	---	NA	---	---	---	NA	---	---	---	24.5	6.13	1.50	5.38	
	 3.5D / 3.5DA	20 19 18 16 14	NA	---	---	---	NA	---	---	---	NA	---	---	---	NA	---	---	---	24	8.00	7.25	3.00	
NON-COMPOSITE FLOOR DECK	 0.6C / 0.6CSV	28 26 24 22	NA 30 30 NA	2.50	0.62	0.62	NA 36 36 36	3.04	0.63	0.63	35 35 35 35	2.50	0.75	0.75	30 35 35 35	2.50	0.62	0.62	30 30 30 30	2.50	0.75	0.75	0.75
	 1.0C / 1.0CSV	26 24 22 20	36	4.00	1.13	1.13	32	4.00	1.25	1.01	33	3.67	0.90	0.90	33	3.67	1.00	1.00	36	4.00	1.13	1.13	1.13
	 1.3C / 1.3CSV	26 24 22 20	NA	---	---	---	NA	---	---	---	NA	---	---	---	32	4.57	1.06	1.06	NA	---	---	---	---
	 1.5C	24 22 20 18	NA 36 36 36	6.00	1.75	3.50	30 36 36 36	6.00	1.75	3.50	36 36 36 36	6.00	1.75	3.50	30 36 36 36	6.00	1.75	3.50	36 36 36 36	6.00	1.75	3.50	3.50
	 2C	22 20 18 16	36	12.0	5.00	5.00	36	12.0	5.00	5.00	36	12.0	5.00	5.00	36	12.0	5.00	5.00	36	12.0	5.00	5.00	5.00
	 3C	22 20 18 16	36	12.0	4.75	4.75	36	12.0	4.75	4.75	36	12.0	4.75	4.75	36	12.0	4.75	4.75	36	12.0	4.75	4.75	4.75
COMPOSITE FLOOR DECK	 1.5VL / 1.5VLI	22 20 19 18 16	36	6.0	3.50	1.75	36	6.0	3.50	1.75	36	6.0	3.50	1.75	36	6.0	3.50	1.75	36	6.0	3.50	1.75	1.75
	 1.5VLR	22 20 19 18 16	36	6.00	1.75	3.50	36	6.0	1.75	3.50	36	6.0	1.75	3.50	36	6.0	1.75	3.50	36	6.0	1.75	3.50	3.50
	 2VLI	22 20 19 18 16	36	12.0	5.00	5.00	36	12.0	5.00	5.00	36	12.0	5.00	5.00	36	12.0	5.00	5.00	36	12.0	5.00	5.00	5.00
	 3VLI	22 20 19 18 16	36	12.0	4.75	4.75	36	12.0	4.75	4.75	36	12.0	4.75	4.75	36	12.0	4.75	4.75	36	12.0	4.75	4.75	4.75

DoveTail Deck

If you need the best, you need Vulcraft's DoveTail steel roof deck. The innovative, high-quality decking system boasts a clean, sleek design with distinct shadow lines to provide texture to the ceiling surface.

The DoveTail acoustic steel deck uses pioneering sound-reducing technology to deliver a calm, quiet interior environment – all while reducing overall design costs.

Vulcraft's DoveTail deck delivers.

- Economical 2-inch-deep and long spanning 3.5-inch-deep products
- Excellent acoustic performance with Noise Reduction Coefficient (NRC) of 0.95 to 1.15
- Naturally hides unsightly roof system fasteners with the re-entrant shape of DoveTail Deck
- Factory painted options
- Proven performance listed with UL, FM and IAPMO-UES

For complete performance information, contact Vulcraft to get your Vulcraft DoveTail Roof Deck Catalog or download directly at www.vulcraft.com/catalogs

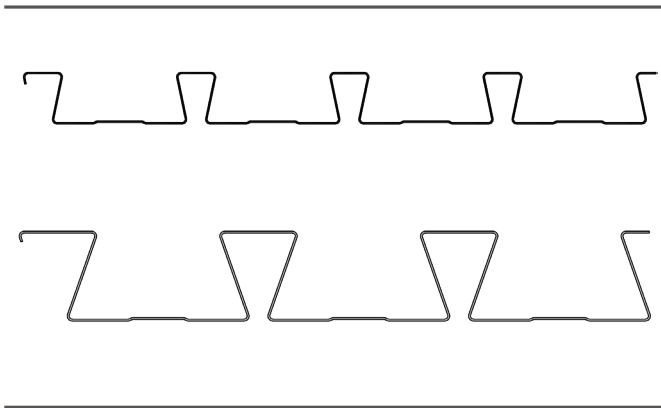

The Vulcraft Structural DoveTail Ceiling/Deck is available in 2-inch-deep and 3.5-inch-deep profiles.



Acoustical Cellular Deck

Cellular deck is used for flat acoustical ceilings, canopies, long spans, and heavy forms. Vulcraft cellular units are approved by U.L. for use as electrical raceways. Contact your Vulcraft representative for more information.



NOISE REDUCTION COEFFICIENTS OF ACOUSTICAL CELLULAR DECK

Deck Type	Above Deck Material	Fiberglass Deck Insulation	Absorption Coefficients						SSA	NRC	RAL Test No.
			125 Hz	250 Hz	500 Hz	1000 Hz	2000 Hz	4000 Hz			
Cellular Roof Deck											
1.5BPA	2" Poly-Iso	Plain (3 pcf)	0.27	0.32	0.70	1.02	0.80	0.52	0.69	0.70	A15-114
3NPA	2" Poly-Iso	Plain (3 pcf)	0.25	0.47	0.92	0.75	0.62	0.54	0.69	0.70	A15-141
Cellular Composite Floor Deck											
1.5VLPA	Concrete	Plain (3 pcf)	0.21	0.29	0.64	0.96	0.74	0.51	0.65	0.65	A15-118
2VLPA	Concrete	Plain (3 pcf)	0.31	0.44	0.72	0.77	0.47	0.47	0.60	0.60	A15-120
3VLPA	Concrete	Plain (3 pcf)	0.48	0.59	1.00	0.75	0.49	0.49	0.69	0.70	A15-121

Acoustical Roof Deck

Acoustical decks can provide sound attenuation within buildings where the decks are exposed to the interior. Acoustical deck is particularly suitable in structures such as auditoriums, schools, gymnasiums and theaters where sound control is desirable.



NOISE REDUCTION COEFFICIENTS OF ACOUSTICAL DECK

Deck Type	Above Deck Material	Fiberglass Deck Insulation	Absorption Coefficients						SSA	NRC	RAL Test No.
			125 Hz	250 Hz	500 Hz	1000 Hz	2000 Hz	4000 Hz			
Roof Deck											
1.5BA or 1.5BIA	2" Poly-Iso	Plain (0.75 pcf)	0.09	0.20	0.47	0.97	0.55	0.32	0.55	0.55	A15-125
	2" Fiberglass	Plain (0.75 pcf)	0.68	1.16	1.17	0.96	0.52	0.31	0.95	0.95	A15-126
3NA or 3NIA	2" Poly-Iso	Plain (0.75 pcf)	0.19	0.33	0.73	0.83	0.48	0.33	0.59	0.60	A15-130
	2" Fiberglass	Plain (0.75 pcf)	0.81	1.16	1.15	0.91	0.47	0.27	0.92	0.90	A15-128
DoveTail Deck											
2.0DA	2" Poly-Iso	Plain (3 pcf)	0.19	0.54	1.15	1.07	1.01	0.79	0.95	0.95	A14-170
	2" Fiberglass	Plain (3 pcf)	0.74	1.40	1.25	1.03	0.98	0.80	1.14	1.15	A14-169
3.5DA	2" Poly-Iso	Plain (3 pcf)	0.25	0.74	1.13	1.06	0.97	0.75	0.96	1.00	A14-186
	2" Fiberglass	Plain (3 pcf)	0.92	1.51	1.13	1.06	0.98	0.78	1.14	1.15	A14-187

Acoustical Notes:

- 1) For acoustical test reports please contact your Vulcraft representative.
- 2) Contact your Vulcraft representative for acoustical performance data of alternate assemblies.

CELLULAR DECK PRODUCTS

CELLULAR ROOF DECK

Vulcraft produces the following acoustical and non-acoustical cellular roof decks:

Cellular Roof Deck Profiles: 1.5BP and 3NP
 Cellular Acoustical Roof Deck Profiles: 1.5BPA and 3NPA

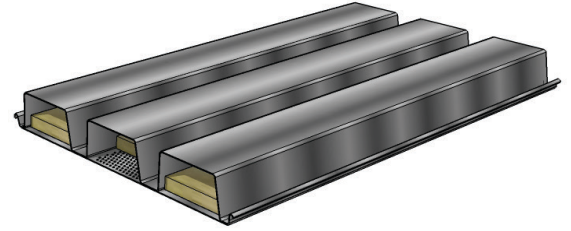

CELLULAR COMPOSITE FLOOR DECK

Vulcraft produces the following acoustical and non-acoustical cellular composite floor decks:

Cellular Composite Floor Deck Profiles: 1.5VLP, 2VLP and 3VLP
 Cellular Acoustical Composite Floor Deck Profiles: 1.5VLPA, 2VLPA and 3VLPA

Cellular decks are available in the following gage combinations (hat / pan): 20/20, 20/18, 18/20, 18/18, 18/16, 16/18, and 16/16.

CELLULAR DECK DESIGN

Design of cellular deck may be conservatively based on the guidelines outlined below. Please contact your Vulcraft representative if more detailed information is required.

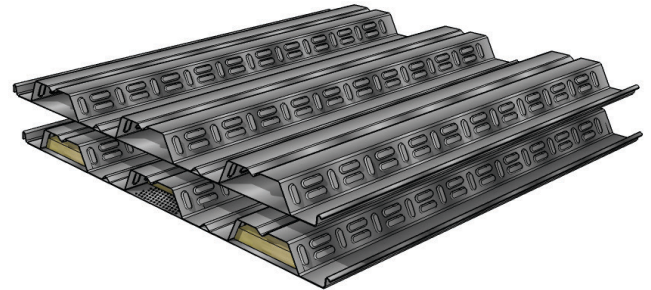

CELLULAR ROOF DECK

Vertical Load Design: Vertical load design of cellular deck may be based on the properties of fluted deck of the same gage and profile as the fluted top section, with or without acoustical perforations in the flat bottom section of the cellular deck.

Diaphragm Design: Diaphragm shear strength and flexibility factors for B and N fluted decks are applicable to cellular sections with a fluted top section of the same profile but with the gage of the flat bottom sheet, with or without acoustical perforations in the flat bottom section of the cellular deck. See “Roof Deck Legacy Diaphragm Tables”, available at www.vulcraft.com/catalogs for B and N roof deck diaphragm tables.

CELLULAR COMPOSITE FLOOR DECK

Unshored Clear Spans: Determination of maximum unshored clear spans of cellular deck may be based on the properties of fluted deck of the same gage and profile as the fluted top section, with or without acoustical perforations in the flat bottom section of the cellular deck.

Superimposed Live Load: Superimposed live loads for Vulcraft composite decks for a given concrete type and thickness may be applied to composite cellular sections with a fluted top section of the same profile and gage, with or without acoustical perforations in the flat bottom section of the cellular deck.

Diaphragm Design: Diaphragm shear strength and flexibility factors shown on pages 68 to 69 for fluted composite decks are applicable to cellular sections with a fluted top section of the same profile but with the gage of the flat bottom sheet, with or without acoustical perforations in the flat bottom section of the cellular deck.

LEED

Vulcraft Group –

Vulcraft - Florence, SC; Norfolk, NE; Brigham City, UT; Grapeland, TX; St. Joe, IN; Fort Payne, AL; Chemung, NY; Nisku, AB; Ancaster, ON

Verco Decking, Inc. – Phoenix, AZ; Fontana, CA; Antioch, CA



Joists/Structural Products - The bar steel for Vulcraft joists is typically obtained from one of the ten (10) Nucor bar mills. That would mean that the average recycled content percentage for the Vulcraft group is 94.6%. The post- and pre-consumer recycled content have been calculated to be 83.0% and 11.7% respectively. Specific project information is available from facility representatives.

Deck – Steel for decking produced by Vulcraft facilities is typically obtained from one of the seven (7) Nucor sheet mills. That would mean that the Vulcraft deck products contain 60.6% recycled steel. The post- and pre-consumer recycled content were calculated to be 31.7% and 28.9% respectively. Verco Decking, Inc. may obtain steel from sources outside of Nucor that may contain lower amounts of recycled content. Specific product information regarding Verco Decking, Inc., and individual Vulcraft locations is available from facility representatives.

LEED v4 Information

Nucor can provide a variety of documentation to help projects satisfy LEED v4 credit requirements. Nucor publishes a Corporate Sustainability Report bi-annually which can be found here - <http://nucor.com/responsibility/sustainability/performance/>.

Additional LEED and/or other environmental information regarding specific Nucor Corporation products for a customer’s specific order is available from facility representatives or the corporate office. A current contact list can be found here - http://nucor.com/media/Nucor_LEED_CONTACTS.pdf.

Additional industry information is available on-line through the Steel Recycling Institute at <http://www.recycle-steel.org>.

We continue to develop product-specific Environmental Product Declarations and Health Product Declarations for a variety of product groups. Nucor has participated in multiple industry-wide Environmental Product Declarations which can be used for Nucor products. Additionally Nucor will work individually with any customer requiring product life cycle inventory data or other environmental footprint information.

Regional Materials – LEED 2009 Credit 5; LEED v4 Local Sourcing

Nucor tracks the origin of scrap shipments to our mills. Nucor can approximate the amount of scrap recovered from any project site region. Nucor owns steel and steel products manufacturing facilities throughout the US that are often within 500 miles of the project site. Please refer to the LEED Contact List (<http://nucor.com/responsibility/sustainability/compliance/leed/>, then click on “LEED Contact”), and contact the specific Nucor representative at the facility directly.

2016 Recycled Steel Content of Nucor Products (% by Total Weight)	
Product Group	Average Recycled Content
Nucor Bar Products	94.6%
Nucor Engineered Bar Products	86.2%
Nucor Beam Products	76.8%
Nucor Plate Products	66.2%
Nucor Sheet Products	60.6%
Nucor Castrip®	89.3%
Total Nucor Steel Combined	79.2%
Vulcraft Structural Products	94.6%
Vulcraft / Verco Decking	60.6%
Nucor Grating / Fisher-Ludlow Grating	94.6%
Nucor Building Group	79.2%
Harris Rebar	94.6%
Nucor Fastener Products	94.6%
Nucor Wire Products	94.6%
Nucor Cold Finish	86.2%

PunchLok® II System

Vulcraft PunchLok® II roofing and decking system is an easy, low-cost way to install steel roof decks. The PunchLok® II System not only has the highest diaphragm shear, but it also provides the building's owner with incredible value by minimizing steel deck attachments and reducing steel deck gage.

Vulcraft's PunchLok® II System gets the job done right.

- Works with all common steel deck profiles: 1.5PLB, 3.0PLN, 1.5PLVI, 2.0PLVLI, & 3.0PLVLI
- Pneumatic PunchLok® II tool creates the VSC2 crimp connection
- The PunchLok® II system provides a positive, permanent VSC2 sidelap attachment for steel deck
- The VSC2 seam attachments are easily verified through visual inspection

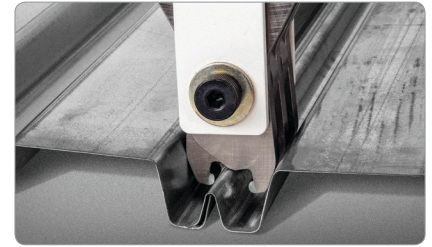

Punch once...

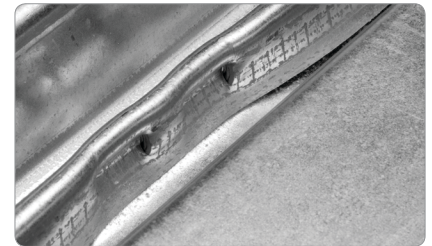

...and forget about it.

PunchLok® II System Brings Value to Your Project

Low Shear < 500 plf						
Deck	Gage	Weld to Supports	Sidelaps		Shear (plf)	PunchLok® II System Value
			# per Span	Type		
B	22	36/7	6	#10 screws	495	<ul style="list-style-type: none"> • Same gage of steel deck, • Fewer sidelap connections, • Eliminates 11,000 welds per 100,000 sf
PLB	22	36/4	2	VSC2	479	
500 plf < Modest Shear < 1000 plf						
Deck	Gage	Weld to Supports	Sidelaps		Shear (plf)	PunchLok® II System Value
			# per Span	Type		
B	18	36/7	7	#10 screws	842	<ul style="list-style-type: none"> • 22 ga PLB saves 52 tons of steel per 100,000 sf, • Fewer sidelap connections, • Eliminates 11,000 welds per 100,000 sf
PLB	22	36/4	6	VSC2	856	
High Shear > 1000 plf						
Deck	Gage	Weld to Supports	Sidelaps		Shear (plf)	PunchLok® II System Value
			# per Span	Type		
B	18	36/7	10	Weld	1214	<ul style="list-style-type: none"> • Comparable number of sidelap connections, • 20 ga PLB saves 18 tons of steel per 100,000 sf • Eliminates 66,000 welds per 100,000 sf
PLB	20	36/4	7	VSC2	1259	

Support Welds

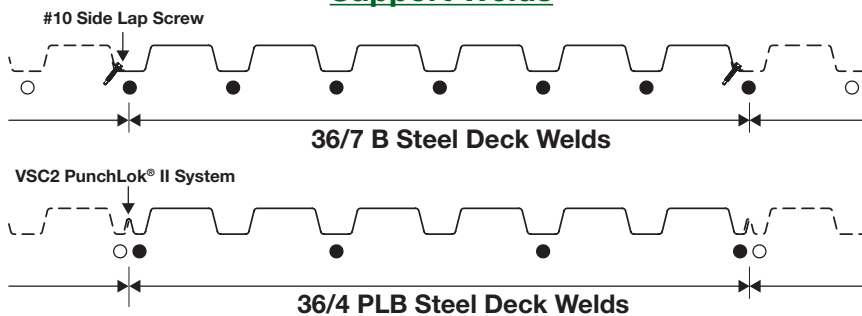

For complete performance information, contact Vulcraft to get your Vulcraft PunchLok® II Roof Deck Catalog or download directly at www.vulcraft.com/catalogs



PUNCHLOK® II

1.5B / 1.5BI / 1.5BA / 1.5BIA ROOF DECK

- Maximum Sheet Length 42'-0"
- Extra charge for lengths under 6'-0"
- ICC ESR-1227
- FM Global Approved

DIMENSIONS

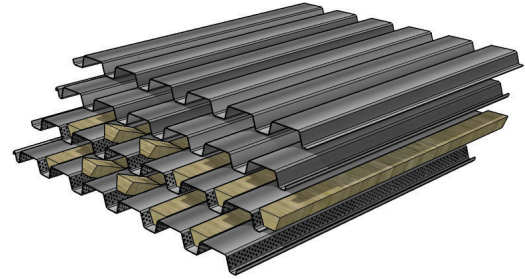
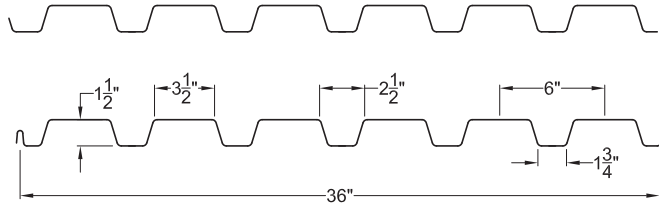

SECTION PROPERTIES

Deck Type	Design Thickness (in.)	Deck Weight (psf)	Section Properties					
			I_p (in ⁴ /ft)	S_p (in ³ /ft)	I_n (in ⁴ /ft)	S_n (in ³ /ft)	V_a (lbs/ft)	F_y (ksi)
B24	0.0239	1.46	0.107	0.120	0.135	0.131	2634	60
B22	0.0295	1.78	0.155	0.186	0.183	0.192	1818	33
B20	0.0358	2.14	0.201	0.234	0.222	0.247	2193	33
B19	0.0418	2.49	0.246	0.277	0.260	0.289	2546	33
B18	0.0474	2.82	0.289	0.318	0.295	0.327	2870	33
B16	0.0598	3.54	0.373	0.408	0.373	0.411	3578	33

VERTICAL LOADS FOR TYPE 1.5B

No. of Spans	Deck Type	Max. SDI Const. Span	Allowable Total Load (psf) / Load Causing Deflection of L/240 or 1 inch (psf)										
			Span (ft.-in.) ctr to ctr of supports										
			5-0	5-6	6-0	6-6	7-0	7-6	8-0	8-6	9-0	9-6	10-0
1	B24	4'-8	115 / 56	95 / 42	80 / 32	68 / 26	59 / 20	51 / 17	45 / 14	40 / 11	35 / 10	32 / 8	29 / 7
	B22	5'-7	98 / 81	81 / 61	68 / 47	58 / 37	50 / 30	44 / 24	38 / 20	34 / 17	30 / 14	27 / 12	25 / 10
	B20	6'-5	123 / 105	102 / 79	86 / 61	73 / 48	63 / 38	55 / 31	48 / 26	43 / 21	38 / 18	34 / 15	31 / 13
	B19	7'-1	146 / 129	121 / 97	101 / 75	86 / 59	74 / 47	65 / 38	57 / 31	51 / 26	45 / 22	40 / 19	36 / 16
	B18	7'-8	168 / 152	138 / 114	116 / 88	99 / 69	85 / 55	74 / 45	65 / 37	58 / 31	52 / 26	46 / 22	42 / 19
	B16	8'-8	215 / 196	178 / 147	149 / 113	127 / 89	110 / 71	96 / 58	84 / 48	74 / 40	66 / 34	60 / 29	54 / 24
2	B24	5'-10	124 / 153	103 / 115	86 / 88	74 / 70	64 / 56	56 / 45	49 / 37	43 / 31	39 / 26	35 / 22	31 / 19
	B22	6'-11	100 / 213	83 / 160	70 / 124	59 / 97	51 / 78	45 / 63	39 / 52	35 / 43	31 / 37	28 / 31	25 / 27
	B20	7'-9	128 / 267	106 / 201	89 / 155	76 / 122	66 / 97	57 / 79	51 / 65	45 / 54	40 / 46	36 / 39	32 / 33
	B19	8'-5	150 / 320	124 / 240	104 / 185	89 / 145	77 / 116	67 / 95	59 / 78	52 / 65	47 / 55	42 / 47	38 / 40
	B18	9'-1	169 / 369	140 / 277	118 / 213	101 / 168	87 / 134	76 / 109	67 / 90	59 / 75	53 / 63	48 / 54	43 / 46
	B16	10'-3	213 / 471	176 / 354	149 / 273	127 / 214	110 / 172	95 / 140	84 / 115	74 / 96	66 / 81	60 / 69	54 / 59
3	B24	5'-10	154 / 120	128 / 90	108 / 69	92 / 55	79 / 44	69 / 35	61 / 29	54 / 24	48 / 21	43 / 17	39 / 15
	B22	6'-11	124 / 167	103 / 126	87 / 97	74 / 76	64 / 61	56 / 50	49 / 41	43 / 34	39 / 29	35 / 24	31 / 21
	B20	7'-9	159 / 209	132 / 157	111 / 121	95 / 95	82 / 76	72 / 62	63 / 51	56 / 43	50 / 36	45 / 31	40 / 26
	B19	8'-5	186 / 250	154 / 188	130 / 145	111 / 114	96 / 91	84 / 74	74 / 61	65 / 51	58 / 43	52 / 37	47 / 31
	B18	9'-1	210 / 289	174 / 217	147 / 167	126 / 132	108 / 105	95 / 86	83 / 71	74 / 59	66 / 50	59 / 42	54 / 36
	B16	10'-3	264 / 369	219 / 277	185 / 214	158 / 168	136 / 135	119 / 109	105 / 90	93 / 75	83 / 63	74 / 54	67 / 46

Notes:

- 1) Minimum exterior bearing length required is 1.50 inches. Minimum interior bearing length is 3.00 inches. If these minimum lengths are not provided, web crippling must be checked.
- 2) FM Global approved spans available on page 23.

3N / 3NI / 3NA / 3NIA ROOF DECK

- Maximum Sheet Length 42'-0"
- Extra charge for lengths under 6'-0"
- ICC ESR-1227
- FM Global Approved

DIMENSIONS

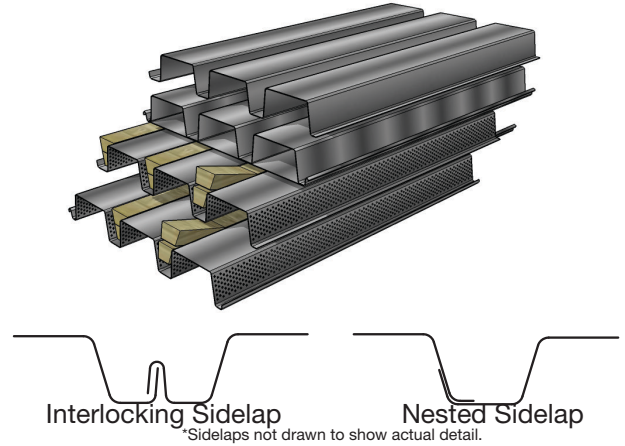
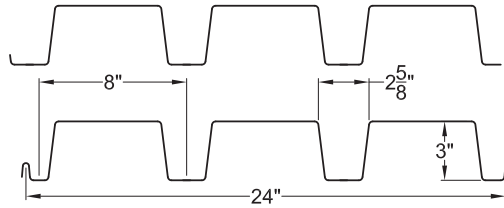

SECTION PROPERTIES

Deck Type	Design Thickness (in.)	Deck Weight (psf)	Section Properties					
			I_p (in ⁴ /ft)	S_p (in ³ /ft)	I_n (in ⁴ /ft)	S_n (in ³ /ft)	V_a (lbs/ft)	F_y (ksi)
N22	0.0295	2.26	0.659	0.382	0.884	0.433	2232	33
N20	0.0358	2.71	0.848	0.501	1.079	0.552	3287	33
N19	0.0418	3.15	1.045	0.597	1.260	0.659	4217	33
N18	0.0474	3.56	1.238	0.688	1.430	0.749	4771	33
N16	0.0598	4.46	1.683	0.893	1.807	0.944	5988	33

VERTICAL LOADS FOR TYPE 3N

No. of Spans	Deck Type	Max. SDI Const. Span	Allowable Total Load (psf) / Load Causing Deflection of L/240 or 1 inch (psf)										
			Span (ft-in.) ctr to ctr of supports										
			10-0	10-6	11-0	11-6	12-0	12-6	13-0	13-6	14-0	14-6	15-0
1	N22	11'-7	50 / 43	46 / 37	42 / 32	38 / 28	35 / 25	32 / 22	30 / 20	28 / 18	26 / 16	24 / 14	22 / 13
	N20	13'-2	66 / 56	60 / 48	55 / 42	50 / 37	46 / 32	42 / 28	39 / 25	36 / 23	34 / 20	31 / 18	29 / 16
	N19	14'-7	79 / 69	71 / 59	65 / 51	59 / 45	55 / 40	50 / 35	47 / 31	43 / 28	40 / 25	37 / 22	35 / 20
	N18	15'-11	91 / 81	82 / 70	75 / 61	69 / 53	63 / 47	58 / 42	54 / 37	50 / 33	46 / 30	43 / 27	40 / 24
	N16	18'-6	118 / 110	107 / 95	97 / 83	89 / 73	82 / 64	75 / 56	70 / 50	65 / 45	60 / 40	56 / 36	52 / 33
2	N22	13'-8	56 / 122	51 / 105	47 / 92	43 / 80	39 / 71	36 / 62	34 / 55	31 / 50	29 / 44	27 / 40	25 / 36
	N20	15'-6	72 / 152	65 / 131	60 / 114	55 / 100	50 / 88	46 / 78	43 / 69	40 / 62	37 / 55	34 / 50	32 / 45
	N19	16'-11	86 / 182	78 / 157	71 / 137	65 / 120	60 / 105	55 / 93	51 / 83	47 / 74	44 / 66	41 / 60	38 / 54
	N18	18'-1	98 / 211	89 / 182	81 / 158	74 / 139	68 / 122	63 / 108	58 / 96	54 / 86	50 / 77	47 / 69	44 / 62
	N16	20'-4	123 / 276	112 / 238	102 / 207	93 / 181	86 / 159	79 / 141	73 / 125	68 / 112	63 / 100	59 / 90	55 / 82
3	N22	13'-8	69 / 95	64 / 82	58 / 72	53 / 63	49 / 55	45 / 49	42 / 43	39 / 39	36 / 35	34 / 31	31 / 28
	N20	15'-6	90 / 119	81 / 103	74 / 90	68 / 78	63 / 69	58 / 61	53 / 54	50 / 48	46 / 43	43 / 39	40 / 35
	N19	16'-11	107 / 143	97 / 123	89 / 107	81 / 94	75 / 83	69 / 73	64 / 65	59 / 58	55 / 52	51 / 47	48 / 42
	N18	18'-1	122 / 165	111 / 143	101 / 124	92 / 109	85 / 96	78 / 84	72 / 75	67 / 67	63 / 60	58 / 54	55 / 49
	N16	20'-4	154 / 216	139 / 186	127 / 162	116 / 142	107 / 125	99 / 111	91 / 98	85 / 88	79 / 79	74 / 71	69 / 64

Notes:

- 1) Minimum exterior bearing length required is 1.50 inches. Minimum interior bearing length is 3.00 inches. If these minimum lengths are not provided, web crippling must be checked.
- 2) FM Global approved spans available on page 23.

1.5F ROOF DECK

- Maximum Sheet Length 42'-0"
- Extra charge for lengths under 6'-0"
- ICC ESR-1227
- FM Global Approved

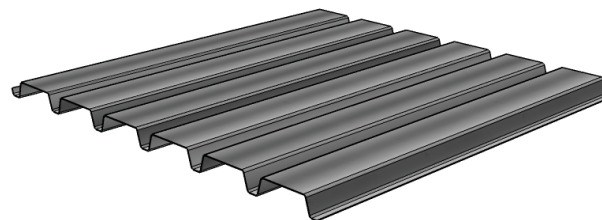

DIMENSIONS

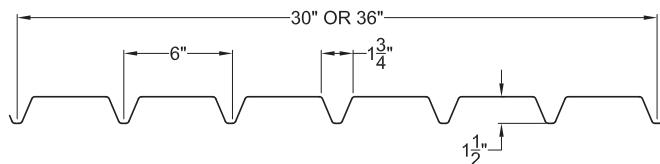

SECTION PROPERTIES

Deck Type	Design Thickness (in.)	Deck Weight (psf)	Section Properties					
			I_p (in ⁴ /ft)	S_p (in ³ /ft)	I_n (in ⁴ /ft)	S_n (in ³ /ft)	V_a (lbs/ft)	F_y (ksi)
F22	0.0295	1.73	0.113	0.112	0.129	0.121	1944	33
F20	0.0358	2.09	0.145	0.139	0.157	0.148	2347	33
F19	0.0418	2.42	0.177	0.166	0.183	0.172	2726	33
F18	0.0474	2.74	0.206	0.190	0.208	0.195	3077	33

VERTICAL LOADS FOR TYPE 1.5F

No. of Spans	Deck Type	Max. SDI Const. Span	Allowable Total Load (psf) / Load Causing Deflection of L/240 or 1 inch (psf)										
			Span (ft.-in.) ctr to ctr of supports										
			4-0	4-6	5-0	5-6	6-0	6-6	7-0	7-6	8-0	8-6	9-0
1	F22	4'-3	92 / 116	73 / 81	59 / 59	49 / 45	41 / 34	35 / 27	30 / 22	26 / 18	23 / 14	20 / 12	18 / 10
	F20	5'-4	114 / 149	90 / 104	73 / 76	61 / 57	51 / 44	43 / 35	37 / 28	33 / 23	29 / 19	25 / 15	23 / 13
	F19	6'-0	137 / 181	108 / 127	87 / 93	72 / 70	61 / 54	52 / 42	45 / 34	39 / 28	34 / 23	30 / 19	27 / 16
	F18	6'-5	156 / 211	124 / 148	100 / 108	83 / 81	70 / 63	59 / 49	51 / 39	44 / 32	39 / 26	35 / 22	31 / 19
2	F22	5'-3	99 / 299	78 / 210	63 / 153	52 / 115	44 / 88	38 / 70	32 / 56	28 / 45	25 / 37	22 / 31	20 / 26
	F20	6'-6	121 / 373	96 / 262	78 / 191	64 / 143	54 / 110	46 / 87	40 / 70	35 / 57	30 / 47	27 / 39	24 / 33
	F19	7'-1	140 / 444	111 / 312	90 / 227	75 / 171	63 / 132	53 / 104	46 / 83	40 / 67	35 / 56	31 / 46	28 / 39
	F18	7'-8	159 / 511	126 / 359	102 / 262	85 / 196	71 / 151	61 / 119	52 / 95	46 / 77	40 / 64	35 / 53	32 / 45
3	F22	5'-3	123 / 234	97 / 164	79 / 120	65 / 90	55 / 69	47 / 55	41 / 44	35 / 35	31 / 29	28 / 24	25 / 21
	F20	6'-6	151 / 292	119 / 205	97 / 149	80 / 112	67 / 86	57 / 68	50 / 54	43 / 44	38 / 36	34 / 30	30 / 26
	F19	7'-1	175 / 348	139 / 244	112 / 178	93 / 134	78 / 103	67 / 81	58 / 65	50 / 53	44 / 43	39 / 36	35 / 31
	F18	7'-8	198 / 400	157 / 281	127 / 205	105 / 154	89 / 119	76 / 93	65 / 75	57 / 61	50 / 50	44 / 42	40 / 35

Notes:
 1) Minimum exterior bearing length required is 1.50 inches. Minimum interior bearing length is 3.00 inches. If these minimum lengths are not provided, web crippling must be checked.
 2) FM Global approved spans available on page 23.

1.5A ROOF DECK

- Maximum Sheet Length 42'-0"
- Extra charge for lengths under 6'-0"
- ICC ESR-1227
- FM Global Approved

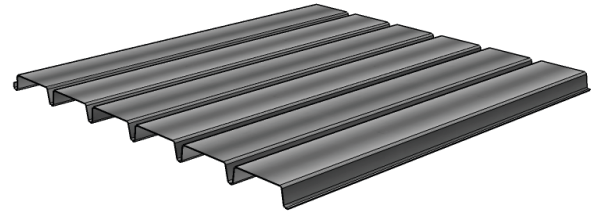

DIMENSIONS

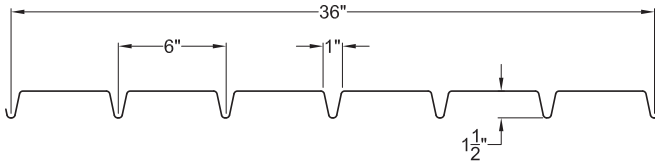

SECTION PROPERTIES

Deck Type	Design Thickness (in.)	Deck Weight (psf)	Section Properties					V _a (lbs/ft)	F _y (ksi)
			I _p (in ⁴ /ft)	S _p (in ³ /ft)	I _n (in ⁴ /ft)	S _n (in ³ /ft)			
A22	0.0295	1.80	0.104	0.098	0.120	0.106	1700	33	
A20	0.0358	2.16	0.134	0.122	0.145	0.130	2049	33	
A19	0.0418	2.51	0.163	0.145	0.170	0.152	2377	33	
A18	0.0474	2.84	0.190	0.167	0.193	0.172	2679	33	

VERTICAL LOADS FOR TYPE 1.5A

No. of Spans	Deck Type	Max. SDI Const. Span	Allowable Total Load (psf) / Load Causing Deflection of L/240 or 1 inch (psf)										
			Span (ft-in.) ctr to ctr of supports										
			4-0	4-6	5-0	5-6	6-0	6-6	7-0	7-6	8-0	8-6	9-0
1	A22	3'-9"	81 / 107	64 / 75	52 / 55	43 / 41	36 / 32	31 / 25	26 / 20	23 / 16	20 / 13	18 / 11	16 / 9
	A20	4'-8"	100 / 137	79 / 96	64 / 70	53 / 53	45 / 41	38 / 32	33 / 26	29 / 21	25 / 17	22 / 14	20 / 12
	A19	5'-6"	119 / 167	94 / 117	76 / 85	63 / 64	53 / 49	45 / 39	39 / 31	34 / 25	30 / 21	26 / 17	24 / 15
	A18	6'-2"	138 / 195	109 / 137	88 / 100	73 / 75	61 / 58	52 / 45	45 / 36	39 / 30	34 / 24	30 / 20	27 / 17
2	A22	4'-7"	87 / 276	69 / 194	56 / 141	46 / 106	39 / 82	33 / 64	28 / 52	25 / 42	22 / 35	19 / 29	17 / 24
	A20	5'-9"	106 / 344	84 / 242	68 / 176	56 / 132	47 / 102	40 / 80	35 / 64	30 / 52	27 / 43	24 / 36	21 / 30
	A19	6'-10"	124 / 411	98 / 289	80 / 210	66 / 158	55 / 122	47 / 96	41 / 77	36 / 62	31 / 51	28 / 43	25 / 36
	A18	7'-4"	140 / 473	111 / 332	90 / 242	75 / 182	63 / 140	53 / 110	46 / 88	40 / 72	35 / 59	31 / 49	28 / 41
3	A22	4'-7"	108 / 216	85 / 152	69 / 111	57 / 83	48 / 64	41 / 50	35 / 40	31 / 33	27 / 27	24 / 23	21 / 19
	A20	5'-9"	132 / 270	105 / 189	85 / 138	70 / 104	59 / 80	50 / 63	44 / 50	38 / 41	33 / 34	30 / 28	26 / 24
	A19	6'-10"	155 / 322	122 / 226	99 / 165	82 / 124	69 / 95	59 / 75	51 / 60	44 / 49	39 / 40	35 / 34	31 / 28
	A18	7'-4"	175 / 370	138 / 260	112 / 190	93 / 142	78 / 110	67 / 86	58 / 69	50 / 56	44 / 46	39 / 39	35 / 32

- Notes:**
 1) Minimum exterior bearing length required is 1.50 inches. Minimum interior bearing length is 3.00 inches. If these minimum lengths are not provided, web crippling must be checked.
 2) FM Global approved spans available on page 23.

2.0D DOVETAIL DECK

- Maximum Sheet Length 42'-0"
- Extra charge for lengths under 6'-0"
- IAPMO ER-0423
- FM Global Approved

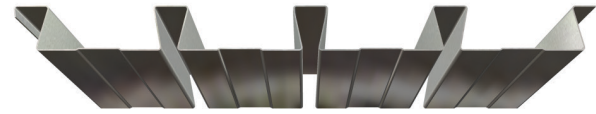

DIMENSIONS

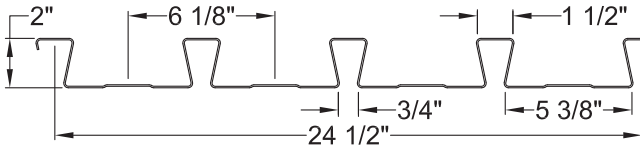

SECTION PROPERTIES

Deck Type	Design Thickness (in.)	Deck Weight (psf)	Section Properties					
			I_d (in ⁴ /ft)	S_{e+} (in ³ /ft)	I_d (in ⁴ /ft)	S_{e-} (in ³ /ft)	V_a (lbs/ft)	F_y (ksi)
2.0D22	0.0295	2.13	0.387	0.272	0.359	0.272	2944	40
2.0D20	0.0358	2.59	0.472	0.343	0.447	0.334	3557	40
2.0D18	0.0474	3.43	0.626	0.463	0.612	0.450	4671	40
2.0D16	0.0598	4.34	0.792	0.587	0.791	0.576	5841	40

VERTICAL LOADS FOR TYPE 2.0D

No. of Spans	Deck Type	Allowable Total Load (psf) / Load Causing Deflection of L/240 (psf)									
		Span (ft-in.) ctr to ctr of supports									
		5-0	6-0	7-0	8-0	9-0	10-0	11-0	12-0	13-0	14-0
1	2D22	174 / ♦♦♦	121 / 118	89 / 74	68 / 50	54 / 35	43 / 25	36 / 19	30 / 15	26 / 12	22 / 9
	2D20	219 / ♦♦♦	152 / 143	112 / 90	86 / 61	68 / 43	55 / 31	45 / 23	38 / 18	32 / 14	28 / 11
	2D18	296 / ♦♦♦	205 / 190	151 / 120	116 / 80	91 / 56	74 / 41	61 / 31	51 / 24	44 / 19	38 / 15
	2D16	375 / ♦♦♦	260 / 241	191 / 152	146 / 102	116 / 71	94 / 52	77 / 39	65 / 30	55 / 24	48 / 19
2	2D22	174 / ♦♦♦	121 / ♦♦♦	89 / ♦♦♦	68 / ♦♦♦	54 / ♦♦♦	43 / ♦♦♦	36 / ♦♦♦	30 / ♦♦♦	26 / ♦♦♦	22 / 21
	2D20	213 / ♦♦♦	148 / ♦♦♦	109 / ♦♦♦	83 / ♦♦♦	66 / ♦♦♦	53 / ♦♦♦	44 / ♦♦♦	37 / ♦♦♦	32 / ♦♦♦	27 / 26
	2D18	287 / ♦♦♦	200 / ♦♦♦	147 / ♦♦♦	112 / ♦♦♦	89 / ♦♦♦	72 / ♦♦♦	59 / ♦♦♦	50 / ♦♦♦	43 / ♦♦♦	37 / 35
	2D16	368 / ♦♦♦	255 / ♦♦♦	188 / ♦♦♦	144 / ♦♦♦	114 / ♦♦♦	92 / ♦♦♦	76 / ♦♦♦	64 / ♦♦♦	54 / ♦♦♦	47 / 46
3	2D22	217 / ♦♦♦	151 / ♦♦♦	111 / ♦♦♦	85 / ♦♦♦	67 / 61	54 / 44	45 / 33	38 / 26	32 / 20	28 / 16
	2D20	267 / ♦♦♦	185 / ♦♦♦	136 / ♦♦♦	104 / ♦♦♦	82 / 76	67 / 55	55 / 42	46 / 32	39 / 25	34 / 20
	2D18	359 / ♦♦♦	250 / ♦♦♦	183 / ♦♦♦	140 / ♦♦♦	111 / 104	90 / 79	74 / 57	62 / 44	53 / 34	46 / 28
	2D16	460 / ♦♦♦	319 / ♦♦♦	235 / ♦♦♦	180 / ♦♦♦	142 / 134	115 / 98	95 / 74	80 / 57	68 / 45	59 / 36

- Notes:
- 1) This table does not account for web-crippling. Allowable reactions must be checked based on specific span condition using the allowable reactions shown in the Vulcraft DoveTail Roof Deck Catalog, available at: <http://www.vulcraft.com/decks/dovetail-deck>
 - 2) FM Global approved spans are available at: <http://www.dovetaildeck.com/fm.html>
 - 3) The symbol ♦♦♦ indicates that the allowable uniform load based on deflection exceeds the allowable load based on stress.

See www.dovetaildeck.com for more complete DoveTail deck information.

3.5D DOVETAIL DECK

- Maximum Sheet Length 42'-0"
- Extra charge for lengths under 6'-0"
- IAPMO ER-0423
- FM Global Approved



DIMENSIONS

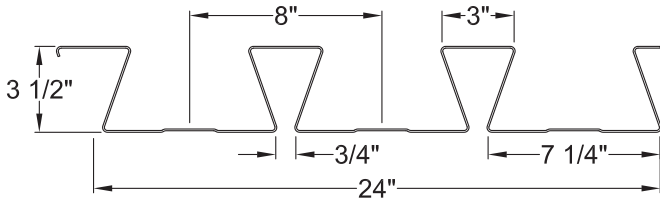

SECTION PROPERTIES

Deck Type	Design Thickness (in.)	Deck Weight (psf)	Section Properties					
			I_d (in ⁴ /ft)	S_{e+} (in ³ /ft)	I_g (in ⁴ /ft)	S_{e-} (in ³ /ft)	V_a (lbs/ft)	F_y (ksi)
3.5D20	0.0358	3.25	1.762	0.676	1.646	0.781	3619	40
3.5D18	0.0474	4.31	2.415	0.980	2.272	1.070	6345	40
3.5D16	0.0598	5.44	3.133	1.317	2.968	1.377	8792	40
3.5D14	0.0747	6.81	3.955	1.742	3.831	1.751	10970	40

VERTICAL LOADS FOR TYPE 3.5D

No. of Spans	Deck Type	Allowable Total Load (psf) / Load Causing Deflection of L/240 (psf)										
		Span (ft-in.) ctr to ctr of supports										
		11-0	12-0	13-0	14-0	15-0	16-0	17-0	18-0	19-0	20-0	21-0
1	3.5D20	89 / 87	75 / 67	64 / 53	55 / 42	48 / 34	42 / 28	37 / 24	33 / 20	30 / 17	27 / 14	24 / 12
	3.5D18	129 / 119	109 / 92	93 / 72	80 / 58	70 / 47	61 / 39	54 / 32	48 / 27	43 / 23	39 / 20	35 / 17
	3.5D16	174 / 155	146 / 119	124 / 94	107 / 75	93 / 61	82 / 50	73 / 42	65 / 35	58 / 30	53 / 26	48 / 22
	3.5D14	230 / 195	193 / 150	165 / 118	142 / 95	124 / 77	109 / 63	96 / 53	86 / 45	77 / 38	70 / 32	63 / 28
2	3.5D20	103 / ♦♦♦	87 / ♦♦♦	74 / ♦♦♦	64 / ♦♦♦	55 / ♦♦♦	49 / ♦♦♦	43 / ♦♦♦	38 / ♦♦♦	35 / ♦♦♦	31 / ♦♦♦	28 / 28
	3.5D18	141 / ♦♦♦	119 / ♦♦♦	101 / ♦♦♦	87 / ♦♦♦	76 / ♦♦♦	67 / ♦♦♦	59 / ♦♦♦	53 / ♦♦♦	47 / ♦♦♦	43 / ♦♦♦	39 / ♦♦♦
	3.5D16	182 / ♦♦♦	153 / ♦♦♦	130 / ♦♦♦	112 / ♦♦♦	98 / ♦♦♦	86 / ♦♦♦	76 / ♦♦♦	68 / ♦♦♦	61 / ♦♦♦	55 / ♦♦♦	50 / ♦♦♦
	3.5D14	231 / ♦♦♦	194 / ♦♦♦	165 / ♦♦♦	143 / ♦♦♦	124 / ♦♦♦	109 / ♦♦♦	97 / ♦♦♦	86 / ♦♦♦	77 / ♦♦♦	70 / ♦♦♦	63 / ♦♦♦
3	3.5D20	121 / ♦♦♦	108 / ♦♦♦	92 / ♦♦♦	80 / 74							
	3.5D18	177 / ♦♦♦	148 / ♦♦♦	126 / ♦♦♦	109 / 102							
	3.5D16	277 / ♦♦♦	191 / ♦♦♦	163 / ♦♦♦	140 / 134							
	3.5D14	289 / ♦♦♦	243 / ♦♦♦	207 / ♦♦♦	178 / 173							

- Notes:**
- 1) This table does not account for web-crippling. Allowable reactions must be checked based on specific span condition using the allowable reactions shown in the Vulcraft DoveTail Roof Deck Catalog, available at: <http://www.vulcraft.com/decks/dovetail-deck>
 - 2) FM Global approved spans are available at: <http://www.dovetaildeck.com/fm.html>
 - 3) The symbol ♦♦♦ indicates that the allowable uniform load based on deflection exceeds the allowable load based on stress.

See www.dovetaildeck.com for more complete DoveTail deck information.

1.0E ROOF DECK

- Maximum Sheet Length 42'-0"
- Extra charge for lengths under 6'-0"
- ICC ESR-1227
- FM Global Approved

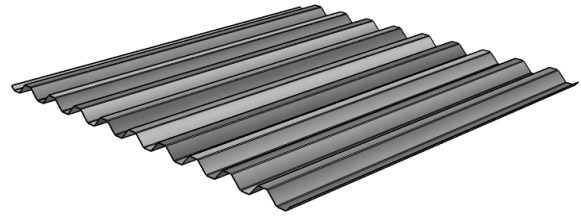

DIMENSIONS

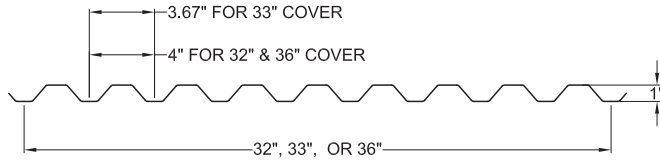

SECTION PROPERTIES

Deck Type	Design Thickness (in.)	Deck Weight (psf)	Section Properties					
			I_p (in ⁴ /ft)	S_p (in ³ /ft)	I_n (in ⁴ /ft)	S_n (in ³ /ft)	V_a (lbs/ft)	F_y (ksi)
E26	0.0179	1.06	0.040	0.067	0.042	0.071	2216	60
E24	0.0239	1.38	0.057	0.098	0.059	0.103	3867	60
E22	0.0295	1.67	0.073	0.130	0.073	0.134	4754	60
E20	0.0358	2.01	0.088	0.167	0.088	0.165	5744	60

VERTICAL LOADS FOR TYPE 1.0E

No. of Spans	Deck Type	Max. SDI Const. Span	Allowable Total Load (psf) / Load Causing Deflection of L/240 or 1 inch (psf)										
			Span (ft-in.) ctr to ctr of supports										
			2-6	3-0	3-6	4-0	4-6	5-0	5-6	6-0	6-6	7-0	7-6
1	E26	2'-10	257 / 168	178 / 97	131 / 61	100 / 41	79 / 29	64 / 21	53 / 16	45 / 12	38 / 10	33 / 8	29 / 6
	E24	3'-5	376 / 239	261 / 138	192 / 87	147 / 58	116 / 41	94 / 30	78 / 22	65 / 17	56 / 14	48 / 11	42 / 9
	E22	3'-10	498 / 306	346 / 177	254 / 112	195 / 75	154 / 53	125 / 38	103 / 29	86 / 22	74 / 17	64 / 14	55 / 11
	E20	4'-2	640 / 369	444 / 214	327 / 135	250 / 90	198 / 63	160 / 46	132 / 35	111 / 27	95 / 21	82 / 17	71 / 14
2	E26	3'-4	267 / 414	187 / 240	138 / 151	106 / 101	84 / 71	68 / 52	56 / 39	47 / 30	40 / 24	35 / 19	30 / 15
	E24	4'-0	390 / 586	272 / 339	200 / 214	153 / 143	121 / 101	98 / 73	81 / 55	68 / 42	58 / 33	50 / 27	44 / 22
	E22	4'-6	506 / 738	353 / 427	260 / 269	199 / 180	158 / 127	128 / 92	106 / 69	89 / 53	76 / 42	65 / 34	57 / 27
	E20	5'-0	623 / 889	435 / 515	320 / 324	246 / 217	194 / 152	158 / 111	130 / 84	109 / 64	93 / 51	81 / 41	70 / 33
3	E26	3'-4	330 / 325	232 / 188	171 / 118	132 / 79	104 / 56	84 / 41	70 / 30	59 / 23	50 / 18	43 / 15	38 / 12
	E24	4'-0	485 / 459	338 / 266	249 / 167	191 / 112	151 / 79	123 / 57	102 / 43	85 / 33	73 / 26	63 / 21	55 / 17
	E22	4'-6	629 / 578	440 / 334	324 / 211	249 / 141	197 / 99	160 / 72	132 / 54	111 / 42	95 / 33	82 / 26	71 / 21
	E20	5'-0	774 / 697	541 / 403	399 / 254	306 / 170	242 / 119	197 / 87	163 / 65	137 / 50	117 / 40	101 / 32	88 / 26

Notes:

1) Minimum exterior bearing length required is 1.50 inches. Minimum interior bearing length is 3.00 inches. If these minimum lengths are not provided, web crippling must be checked.

ROOF DECK FIRE RESISTANCE RATINGS

Restrained Assembly Rating	Type of Protection	Type of Insulation	U.L. Design No. (1,2)	Roof Deck	Unrestrained Beam Rating
1 Hr.	Exposed Grid	Rigid Insulation	P211+	B, BI, F, A	
			P214+	B, BI, F, A	1 Hr.
			P225+	B, BI, F, A	1,1.5 Hr.
			P227+	B, BI, F, A	1,1.5 Hr.
			P230+	B, BI, F, A	1 Hr.
		P235+	B, BI, F, A	1 Hr.	
	Gypsum Board	Rigid Insulation	P510+	B, BI, F, A	
	Cementitious	Rigid Insulation	P701*	B, BI, F, A, N, NI	1,1.5,2 Hr.
			P711*	B, BI, F, N, NI	1,1.5,2 Hr.
			P717*	B, BI, N, NI	1,1.5,2 Hr.
	Sprayed Fiber	Rigid Insulation	P801*	B, BI, F, A, N, NI	1,1.5,2 Hr.
			P815*	B, BI, F, A, N, NI	1,1.5,2 Hr.
			P819*	B, BI, F, N, NI	1,1.5,2 Hr.
	Unprotected Deck	Insulating Fill	P902	B, BI, N, NI	1,1.5,2 Hr.
			P907	B, BI, N, NI	1,1.5,2 Hr.
			P908	B, BI, N, NI	1,1.5,2 Hr.
			P919	B, BI, N, NI	1,1.5 Hr.
			P920	B, BI, N, NI	1,1.5,2 Hr.
			P921	B, BI, N, NI	1,1.5,2 Hr.
			P922	B, BI, N, NI	1,1.5,2 Hr.
			P923	B, BI, N, NI	1,1.5,2 Hr.
1 1/2 Hr.	Exposed Grid	Rigid Insulation	P225+	B, BI, F, A	1,1.5 Hr.
			P227+	B, BI, F, A	1,1.5 Hr.
			P230+	B, BI, F, A	1 Hr.
	Metal Lath	Rigid Insulation	P404+	B, BI	
	Gypsum Board	Rigid Insulation	P510+	B, BI, F, A	
	Cementitious	Rigid Insulation	P701*	B, BI, F, A, N, NI	1,1.5,2 Hr.
			P711*	B, BI, F, N, NI	1,1.5,2 Hr.
			P717*	B, BI, N, NI	1,1.5,2 Hr.
	Sprayed Fiber	Rigid Insulation	P801*	B, BI, F, A, N, NI	1,1.5,2 Hr.
			P815*	B, BI, F, A, N, NI	1,1.5,2 Hr.
			P819*	B, BI, F, N, NI	1,1.5,2 Hr.
	Unprotected Deck	Insulating Fill	P902	B, BI, N, NI	1,1.5,2 Hr.
P907			B, BI, N, NI	1,1.5,2 Hr.	
P908			B, BI, N, NI	1,1.5,2 Hr.	
P919			B, BI, N, NI	1,1.5 Hr.	
P920			B, BI, N, NI	1,1.5,2 Hr.	
P921			B, BI, N, NI	1,1.5,2 Hr.	
P922			B, BI, N, NI	1,1.5,2 Hr.	

Restrained Assembly Rating	Type of Protection	Type of Insulation	U.L. Design No. (1,2)	Roof Deck	Unrestrained Beam Rating
2 Hr.	Exposed Grid	Rigid Insulation	P237+	B, BI, F, A	2 Hr.
	Metal Lath	Rigid Insulation	P404+	B, BI	
	Gypsum Board	Rigid Insulation	P514+	B, BI, F, A	
	Cementitious	Rigid Insulation	P701	B, BI, F, A, N, NI	1,1.5,2 Hr.
			P711*	B, BI, F, N, NI	1,1.5,2 Hr.
			P717*	B, BI, N, NI	1,1.5,2 Hr.
	Sprayed Fiber	Rigid Insulation	P801	B, BI, F, A, N, NI	1,1.5,2 Hr.
			P815*	B, BI, F, A, N, NI	1,1.5,2 Hr.
			P819*	B, BI, F, N, NI	1,1.5,2 Hr.
	Unprotected Deck	Insulating Fill	P902	B, BI, N, NI	1,1.5,2 Hr.
			P907	B, BI, N, NI	1,1.5,2 Hr.
P908			B, BI, N, NI	1,1.5,2 Hr.	
P920			B, BI, N, NI	1,1.5,2 Hr.	
P921			B, BI, N, NI	1,1.5,2 Hr.	
3 Hr.	Metal Lath	Insulating Fill	P923	B, BI, N, NI	1,1.5,2 Hr.

Notes:

1. Refer to the U.L. "Fire Resistance Directory" for the necessary construction details.
 2. Deck finish shall be galvanized unless noted otherwise.
- + Deck finish is not critical for fire resistance when used in P2--, P4--, & P5-- Series designs. Deck finish shall be galvanized or painted.
 - * Denotes deck finish is critical for fire resistance. Deck finish shall be galvanized or painted. This is a special type of paint and is compatible with the spray-applied fire protection and is U.L. approved for use in the denoted P7-- & P8-- Series designs.

ROOF DECK WEB CRIPPLING

Allowable Reactions Due to Web Crippling (lbs/ft)

Deck Type	Reaction Type	One Flange Loading						Two Flange Loading					
		Bearing Length (in.)						Bearing Length (in.)					
		1.5"	2"	2.5"	3"	3.5"	≥4"	1.5"	2"	2.5"	3"	3.5"	≥4"
B24	End	666	734	795	849	899	923	649	702	748	790	829	848
	Interior	979	1066	1142	1211	1275	1306	1175	1289	1389	1479	1563	1603
B22	End	540	593	641	683	722	740	565	608	647	681	713	728
	Interior	806	875	935	990	1040	1062	982	1073	1154	1226	1293	1323
B20	End	771	844	909	968	1022	1044	853	916	971	1021	1067	1086
	Interior	1167	1262	1345	1420	1490	1517	1437	1565	1678	1780	1873	1911
B19	End	1024	1119	1203	1279	1348	1374	1183	1266	1340	1406	1467	1489
	Interior	1567	1690	1797	1895	1984	2017	1944	2111	2259	2392	2515	2559
B18	End	1290	1407	1510	1603	1688	1716	1537	1642	1735	1818	1895	1919
	Interior	1990	2141	2274	2393	2504	2539	2481	2689	2872	3037	3190	3239
B16	End	1977	2147	2297	2433	2557	2587	2485	2643	2783	2909	3025	3053
	Interior	3094	3314	3508	3683	3844	3883	3886	4194	4466	4711	4937	4991
F22	End	511	562	607	647	684	718	532	573	609	642	672	700
	Interior	768	833	891	942	990	1034	932	1018	1094	1163	1226	1284
F20	End	730	800	862	917	969	1014	805	864	916	963	1007	1045
	Interior	1112	1202	1281	1353	1419	1477	1363	1485	1592	1689	1778	1856
F19	End	971	1062	1141	1213	1279	1335	1117	1195	1265	1328	1385	1434
	Interior	1493	1610	1713	1805	1891	1963	1845	2004	2144	2271	2388	2486
F18	End	1224	1335	1432	1520	1602	1667	1453	1552	1639	1718	1790	1849
	Interior	1897	2040	2166	2281	2386	2471	2356	2553	2727	2884	3029	3146
A22	End	554	609	657	701	741	741	582	627	667	703	735	735
	Interior	823	893	954	1010	1060	1060	1006	1100	1182	1256	1324	1324
A20	End	790	866	932	993	1045	1045	879	944	1001	1052	1097	1097
	Interior	1191	1287	1372	1449	1516	1516	1471	1602	1718	1822	1913	1913
A19	End	1050	1147	1233	1311	1374	1374	1217	1303	1378	1447	1503	1503
	Interior	1599	1724	1834	1933	2015	2015	1989	2161	2312	2448	2561	2561
A18	End	1322	1441	1546	1642	1716	1716	1580	1688	1783	1869	1936	1936
	Interior	2030	2183	2319	2441	2537	2537	2538	2751	2938	3107	3240	3240

Allowable Reactions Due to Web Crippling (lbs/ft)

Deck Type	Reaction Type	One Flange Loading						Two Flange Loading					
		Bearing Length (in.)						Bearing Length (in.)					
		2"	3"	4"	5"	6"	≥8"	2"	3"	4"	5"	6"	≥8"
N22	End	420	483	537	584	626	634	394	442	482	517	549	555
	Interior	673	762	836	902	961	972	777	888	981	1063	1137	1151
N20	End	603	691	766	831	891	972	608	678	736	788	835	899
	Interior	972	1094	1197	1288	1370	1482	1141	1297	1429	1546	1651	1795
N19	End	805	920	1016	1101	1178	1315	853	947	1027	1097	1160	1272
	Interior	1301	1459	1593	1710	1816	2005	1546	1752	1926	2078	2217	2462
N18	End	1017	1158	1277	1382	1477	1646	1118	1238	1339	1428	1508	1651
	Interior	1649	1843	2007	2151	2282	2514	1976	2232	2448	2638	2810	3116
N16	End	1563	1771	1946	2100	2240	2487	1831	2015	2170	2307	2430	2650
	Interior	2550	2835	3074	3285	3476	3815	3099	3480	3802	4086	4343	4798

BEARING

Bearing length directly influences allowable reactions governed by web crippling. It is also important to ensure that enough bearing length is provided to meet minimum edge distance requirements for fasteners.

Sufficient bearing at parallel supports should be provided to make the specified connections.

Web Crippling: One vs. Two Flange Loading

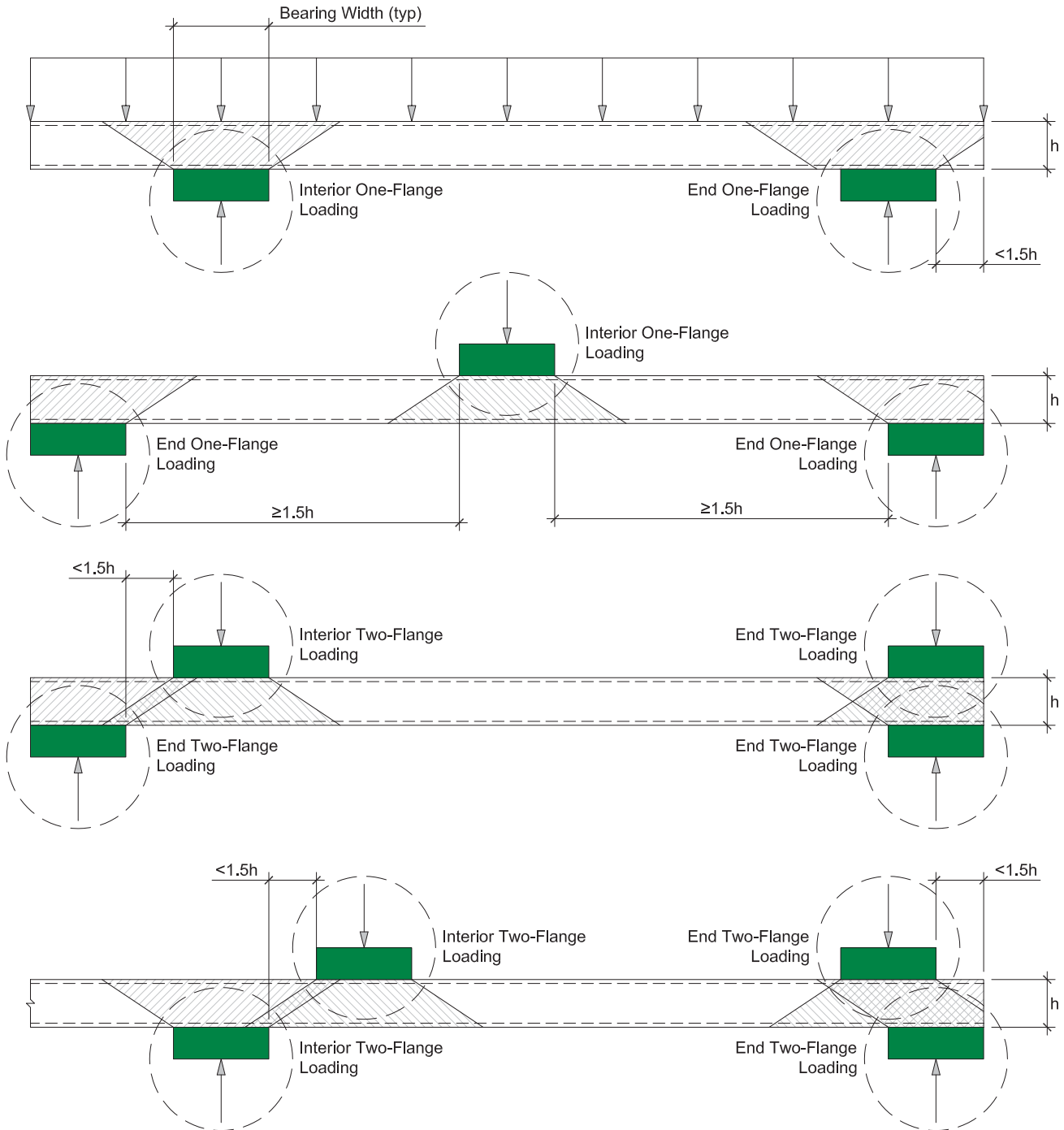

ROOF DECK ACCESSORIES

ROOF

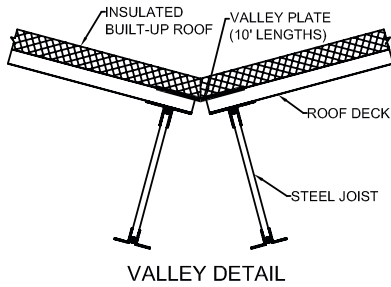

VALLEY DETAIL

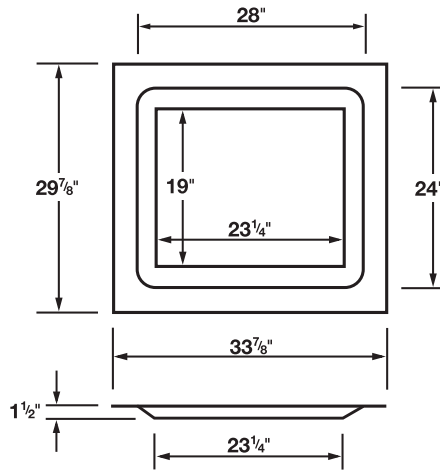

SUMP PANS
14 GA.
GALVANIZED ONLY

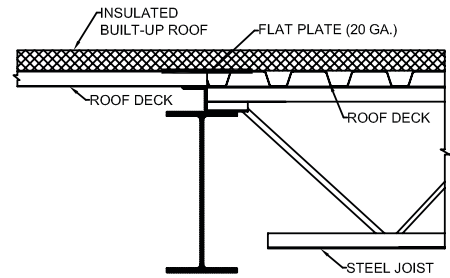

DETAIL WHERE DECK
CHANGES DIRECTION

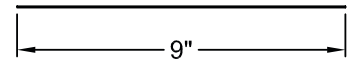

FLAT PLATE (20 GA.)
10'-0" LENGTHS
GALVANIZED ONLY

RIDGE OR VALLEY PLATE (20 GA.)
10'-0" LENGTHS
GALVANIZED ONLY

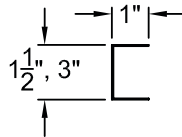
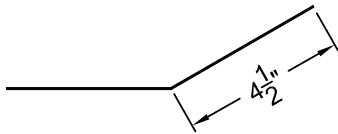

INSIDE OR OUTSIDE CLOSURE (20 GA.)
10'-0" LENGTHS
GALVANIZED ONLY

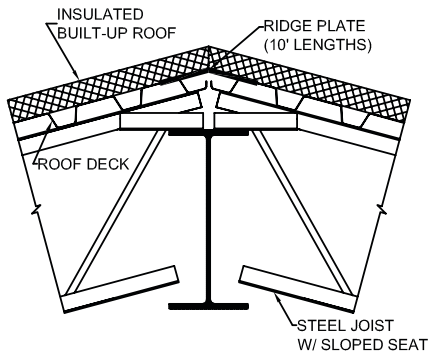

RIDGE DETAIL

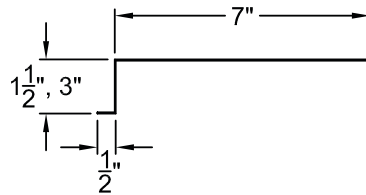

FILLER SHEET (20 GA.)
10'-0" LENGTHS
GALVANIZED ONLY

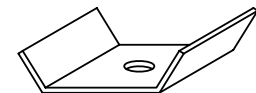

WELDING WASHER
(16 GA.)
3/8" HOLE

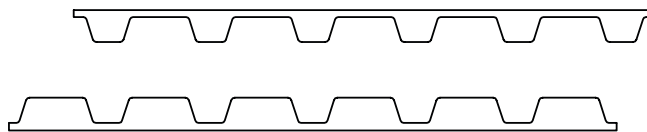

RUBBER CLOSURES
TOP & UNDERSIDE

FM GLOBAL

The tables below provide an abbreviated listing of FM approved spans (c-c) for Vulcraft decks based on live load deflection and wind uplift limited by deck bending and fastener pull-over.

The complete listing of FM allowable spans for Vulcraft decks, including additional profiles and alternate weld sizes is available at <http://www.vulcraft.com/decks/deck-faq>.

The Engineer of Record must investigate the design, including above deck components and selected attachments, as published by FM Global as found at <https://roofnav.fmglobal.com>.

ALLOWABLE SPANS (c-c)

No. of Spans	Deck	5/8" Arc Spot Welds @ 36/4			5/8" Arc Spot Welds @ 36/7		
		1-60	1-75	1-90	1-60	1-75	1-90
1	1.5(B,BI)22	6'-1"	6'-1"	6'-1"	6'-1"	6'-1"	6'-1"
	1.5(B,BI)20	6'-8"	6'-8"	6'-8"	6'-8"	6'-8"	6'-8"
	1.5(B,BI)18	7'-9"	7'-9"	7'-9"	7'-9"	7'-9"	7'-9"
	1.5(B,BI)16	8'-8"	8'-8"	8'-8"	8'-8"	8'-8"	8'-8"
2	1.5(B,BI)22	6'-7"	5'-3"	4'-4"	7'-2"	7'-2"	7'-2"
	1.5(B,BI)20	7'-10"	6'-3"	5'-3"	7'-11"	7'-11"	7'-11"
	1.5(B,BI)18	9'-1"	8'-2"	6'-10"	9'-1"	9'-1"	9'-1"
	1.5(B,BI)16	10'-3"	10'-1"	8'-5"	10'-3"	10'-3"	10'-3"
3	1.5(B,BI)22	7'-2"	6'-7"	5'-5"	7'-2"	7'-2"	7'-2"
	1.5(B,BI)20	7'-11"	7'-10"	6'-7"	7'-11"	7'-11"	7'-11"
	1.5(B,BI)18	9'-1"	9'-1"	8'-6"	9'-1"	9'-1"	9'-1"
	1.5(B,BI)16	10'-3"	10'-3"	10'-3"	10'-3"	10'-3"	10'-3"

No. of Spans	Deck	5/8" Arc Spot Welds @ 24/4		
		1-60	1-75	1-90
1	3(N,NI)22	13'-5"	13'-5"	12'-2"
	3(N,NI)20	14'-10"	14'-10"	13'-10"
	3(N,NI)18	17'-1"	17'-1"	16'-3"
	3(N,NI)16	19'-2"	19'-2"	18'-3"
2	3(N,NI)22	9'-10"	7'-10"	6'-7"
	3(N,NI)20	11'-10"	9'-5"	7'-10"
	3(N,NI)18	15'-4"	12'-3"	10'-3"
	3(N,NI)16	19'-0"	15'-2"	12'-8"
3	3(N,NI)22	12'-4"	9'-10"	8'-2"
	3(N,NI)20	14'-9"	11'-10"	9'-10"
	3(N,NI)18	19'-2"	15'-4"	12'-9"
	3(N,NI)16	22'-8"	19'-0"	15'-10"

NOTES:

- 1) Arc spot weld sizes are visible diameter.
- 2) FM Global reduces deck section properties by 5% to account for acoustical perforations.

Additional decks approved for use in FM constructions include:

Fluted: 1.5A, 1.5F, 2.0D, and 3.5D

Fluted Acoustical: 1.5BA, 1.5BIA, 3NA, 3NIA, 2.0DA, and 3.5DA

Cellular: 1.5BP and 3NP

Cellular Acoustical: 1.5BPA and 3NPA

0.6C / 0.6CSV CONFORM DECK

SECTION PROPERTIES

Deck Gauge	Design Thickness (in)	Deck Weight (psf)	Section Properties				V _a (lbs/ft)	F _y (ksi)
			I _p (in ⁴ /ft)	I _n (in ⁴ /ft)	S _p (in ³ /ft)	S _n (in ³ /ft)		
28	0.0149	0.76	0.012	0.012	0.035	0.036	1179	60
26	0.0179	0.91	0.015	0.015	0.043	0.043	1703	60
24	0.0239	1.21	0.019	0.019	0.057	0.057	2368	60
22	0.0295	1.49	0.024	0.024	0.070	0.070	2946	60

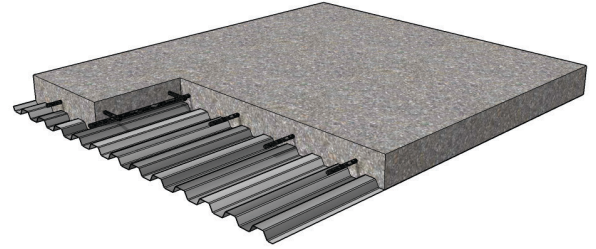

MAXIMUM CONSTRUCTION CLEAR SPANS (S.D.I. CRITERIA) (ft.-in.)

Total Slab Depth	Deck	Weight (psf)	NW Concrete N=9 145 PCF			Weight (psf)	LW Concrete N=14 110 PCF		
			1 SPAN	2 SPAN	3 SPAN		1 SPAN	2 SPAN	3 SPAN
2 (t=1.50)	0.6C28	23	2'-3	2'-9	2'-10	17	2'-4	2'-10	2'-11
	0.6C26	23	2'-9	3'-3	3'-4	18	2'-10	3'-5	3'-6
	0.6C24	23	3'-5	4'-2	4'-2	18	3'-7	4'-4	4'-5
	0.6C22	23	4'-1	4'-10	4'-11	18	4'-3	5'-2	5'-2
2.5 (t=2.00)	0.6C28	29	2'-3	2'-8	2'-8	22	2'-4	2'-9	2'-10
	0.6C26	29	2'-8	3'-2	3'-2	22	2'-9	3'-4	3'-4
	0.6C24	29	3'-4	3'-11	4'-0	22	3'-6	4'-2	4'-3
	0.6C22	29	3'-11	4'-7	4'-8	23	4'-1	4'-11	5'-0
3 (t=2.50)	0.6C28	35	2'-2	2'-7	2'-7	27	2'-3	2'-8	2'-9
	0.6C26	35	2'-7	3'-1	3'-1	27	2'-8	3'-3	3'-3
	0.6C24	35	3'-2	3'-9	3'-10	27	3'-5	4'-0	4'-1
	0.6C22	36	3'-9	4'-5	4'-6	27	4'-0	4'-9	4'-10
3.5 (t=3.00)	0.6C28	41	2'-1	2'-6	2'-6	31	2'-2	2'-8	2'-8
	0.6C26	41	2'-6	2'-11	3'-0	31	2'-7	3'-2	3'-2
	0.6C24	41	3'-1	3'-8	3'-8	32	3'-3	3'-11	3'-11
	0.6C22	42	3'-7	4'-3	4'-4	32	3'-10	4'-7	4'-8
4 (t=3.50)	0.6C28	47	2'-0	2'-5	2'-6	36	2'-2	2'-7	2'-7
	0.6C26	47	2'-5	2'-10	2'-11	36	2'-7	3'-1	3'-1
	0.6C24	47	3'-0	3'-6	3'-7	36	3'-2	3'-9	3'-10
	0.6C22	48	3'-5	4'-1	4'-2	36	3'-9	4'-5	4'-6
4.5 (t=4.00)	0.6C28	53	2'-0	2'-4	2'-5	40	2'-1	2'-6	2'-7
	0.6C26	53	2'-4	2'-9	2'-10	40	2'-6	3'-0	3'-0
	0.6C24	53	2'-11	3'-5	3'-6	41	3'-1	3'-8	3'-9
	0.6C22	54	3'-4	4'-0	4'-0	41	3'-7	4'-3	4'-4
5 (t=4.50)	0.6C28	59	1'-11	2'-4	2'-4	45	2'-1	2'-6	2'-6
	0.6C26	59	2'-3	2'-8	2'-9	45	2'-5	2'-11	2'-11
	0.6C24	59	2'-10	3'-4	3'-4	45	3'-0	3'-7	3'-8
	0.6C22	60	3'-2	3'-10	3'-11	46	3'-6	4'-2	4'-3

Notes:

1) Minimum exterior bearing length required is 1.5". Minimum interior bearing length is 3".

See page 37 for Reinforced Concrete Slab Allowable Loads for 0.6C Deck.

NON-COMPOSITE

0.6C / 0.6CSV CONFORM DECK

DIMENSIONS

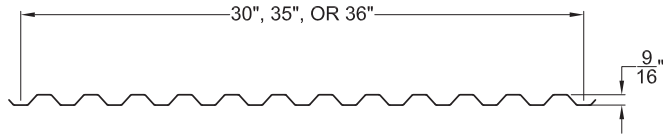

SLAB INFORMATION

Total Slab Depth	Theo. Concrete Volume	
(in.)	(Yd ³ /100 ft ²)	(ft ³ /ft ²)
2	0.52	0.142
2 1/2	0.68	0.183
3	0.83	0.225
3 1/2	0.99	0.267
4	1.14	0.308
4 1/2	1.30	0.350
5	1.46	0.392

*Volumes and weights do not include allowance for deflection.

ALLOWABLE UNIFORM LOAD (PSF)

TYPE NO.	NO. OF SPANS	DESIGN CRITERIA	CLEAR SPAN (ft-in.)												
			2-0	2-3	2-6	2-9	3-0	3-3	3-6	3-9	4-0	4-6	5-0	5-6	6-0
0.6C28	1	Fb = 36,000	210	166	134	111	93	79	68	60	52	41	34	28	23
		Defl. = l/240	98	69	50	38	29	23	18	15	12	9	6	5	4
		Defl. = l/180	131	92	67	51	39	31	25	20	16	12	8	6	5
	2	Fb = 36,000	210	167	136	112	95	81	70	61	54	42	34	28	24
		Defl. = l/240	237	167	121	91	70	55	44	36	30	21	15	11	9
		Defl. = l/180	316	222	162	122	94	74	59	48	40	28	20	15	12
	3	Fb = 36,000	260	207	168	140	118	101	87	76	67	53	43	35	30
		Defl. = l/240	186	130	95	71	55	43	35	28	23	16	12	9	7
		Defl. = l/180	247	174	127	95	73	58	46	38	31	22	16	12	9
0.6C26	1	Fb = 36,000	257	203	165	136	114	98	84	73	64	51	41	34	29
		Defl. = l/240	123	86	63	47	36	29	23	19	15	11	8	6	5
		Defl. = l/180	164	115	84	63	49	38	31	25	21	14	11	8	6
	2	Fb = 36,000	253	201	163	135	114	97	84	73	64	51	41	34	29
		Defl. = l/240	296	208	152	114	88	69	55	45	37	26	19	14	11
		Defl. = l/180	395	278	202	152	117	92	74	60	49	35	25	19	15
	3	Fb = 36,000	314	249	203	168	141	121	104	91	80	63	51	42	36
		Defl. = l/240	232	163	119	89	69	54	43	35	29	20	15	11	9
		Defl. = l/180	309	217	158	119	92	72	58	47	39	27	20	15	11
0.6C24	1	Fb = 36,000	341	270	218	181	152	129	111	97	85	67	55	45	38
		Defl. = l/240	156	110	80	60	46	36	29	24	19	14	10	7	6
		Defl. = l/180	208	146	106	80	62	48	39	32	26	18	13	10	8
	2	Fb = 36,000	336	266	216	179	151	128	111	97	85	67	54	45	38
		Defl. = l/240	375	264	192	144	111	87	70	57	47	33	24	18	14
		Defl. = l/180	501	352	256	193	148	117	93	76	63	44	32	24	19
	3	Fb = 36,000	417	331	269	223	188	160	138	121	106	84	68	56	47
		Defl. = l/240	294	206	150	113	87	68	55	45	37	26	19	14	11
		Defl. = l/180	392	275	201	151	116	91	73	59	49	34	25	19	15
0.6C22	1	Fb = 36,000	419	331	268	222	186	159	137	119	105	83	67	55	47
		Defl. = l/240	197	138	101	76	58	46	37	30	25	17	13	9	7
		Defl. = l/180	263	184	134	101	78	61	49	40	33	23	17	13	10
	2	Fb = 36,000	413	327	266	220	185	158	136	119	104	83	67	55	46
		Defl. = l/240	474	333	243	182	141	111	88	72	59	42	30	23	18
		Defl. = l/180	632	444	324	243	187	147	118	96	79	56	40	30	23
	3	Fb = 36,000	512	407	331	274	231	197	170	148	130	103	84	69	58
		Defl. = l/240	371	261	190	143	110	86	69	56	46	33	24	18	14
		Defl. = l/180	495	348	253	190	147	115	92	75	62	43	32	24	18

1.0C / 1.0CSV CONFORM DECK

SECTION PROPERTIES

Deck Gauge	Design Thickness (in)	Deck Weight (psf)	Section Properties				V _a (lbs/ft)	F _y (ksi)
			I _p (in ⁴ /ft)	I _n (in ⁴ /ft)	S _p (in ³ /ft)	S _n (in ³ /ft)		
26	0.0179	0.96	0.040	0.042	0.067	0.071	1672	60
24	0.0239	1.28	0.057	0.059	0.098	0.103	2922	60
22	0.0295	1.57	0.073	0.073	0.130	0.134	3634	60
20	0.0358	1.91	0.088	0.088	0.167	0.165	4353	60

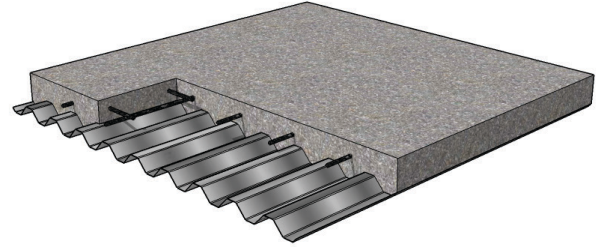

MAXIMUM CONSTRUCTION CLEAR SPANS (S.D.I. CRITERIA) (ft-in.)

Total Slab Depth	Deck	Weight (psf)	NW Concrete N=9 145 PCF			Weight (psf)	LW Concrete N=14 110 PCF		
			1 SPAN	2 SPAN	3 SPAN		1 SPAN	2 SPAN	3 SPAN
2.5 (t=1.50)	1.0C26	25	3'-10	4'-7	4'-8	19	4'-1	4'-11	5'-0
	1.0C24	25	5'-2	6'-2	6'-3	19	5'-6	6'-7	6'-8
	1.0C22	25	6'-0	7'-6	7'-5	20	6'-7	8'-2	8'-2
	1.0C20	26	6'-5	8'-7	7'-11	20	7'-0	9'-4	8'-8
3 (t=2.00)	1.0C26	31	3'-8	4'-5	4'-6	24	3'-11	4'-8	4'-9
	1.0C24	31	4'-11	5'-10	5'-11	24	5'-4	6'-3	6'-4
	1.0C22	31	5'-8	7'-1	7'-0	24	6'-2	7'-9	7'-8
	1.0C20	32	6'-0	8'-0	7'-5	25	6'-7	8'-10	8'-1
3.5 (t=2.50)	1.0C26	37	3'-7	4'-3	4'-3	28	3'-10	4'-6	4'-7
	1.0C24	37	4'-9	5'-7	5'-8	29	5'-1	6'-0	6'-1
	1.0C22	37	5'-4	6'-9	6'-7	29	5'-10	7'-4	7'-3
	1.0C20	38	5'-8	7'-7	7'-0	29	6'-3	8'-4	7'-8
4 (t=3.00)	1.0C26	43	3'-5	4'-1	4'-1	33	3'-8	4'-5	4'-5
	1.0C24	43	4'-6	5'-4	5'-5	33	4'-11	5'-10	5'-10
	1.0C22	43	5'-1	6'-6	6'-4	33	5'-7	7'-1	6'-11
	1.0C20	44	5'-5	7'-3	6'-8	34	5'-11	8'-0	7'-4
4.5 (t=3.50)	1.0C26	49	3'-4	3'-11	4'-0	37	3'-7	4'-3	4'-4
	1.0C24	49	4'-4	5'-2	5'-2	38	4'-9	5'-7	5'-8
	1.0C22	50	4'-11	6'-3	6'-1	38	5'-4	6'-10	6'-8
	1.0C20	50	5'-2	7'-0	6'-5	38	5'-8	7'-8	7'-1
5 (t=4.00)	1.0C26	55	3'-3	3'-10	3'-10	42	3'-6	4'-1	4'-2
	1.0C24	55	4'-3	5'-0	5'-0	42	4'-7	5'-5	5'-6
	1.0C22	56	4'-9	6'-0	5'-10	43	5'-2	6'-7	6'-5
	1.0C20	56	5'-0	6'-9	6'-3	43	5'-6	7'-5	6'-10
5.5 (t=4.50)	1.0C26	61	3'-2	3'-8	3'-9	47	3'-5	4'-0	4'-1
	1.0C24	61	4'-1	4'-10	4'-10	47	4'-6	5'-3	5'-4
	1.0C22	62	4'-7	5'-9	5'-8	47	5'-0	6'-4	6'-2
	1.0C20	62	4'-10	6'-6	6'-0	47	5'-4	7'-2	6'-7

Notes:

1) Minimum exterior bearing length required is 1.5". Minimum interior bearing length is 3".

See page 37 for Reinforced Concrete Slab Allowable Loads for 1.0C Deck.

NON-COMPOSITE

1.0C / 1.0CSV CONFORM DECK

DIMENSIONS

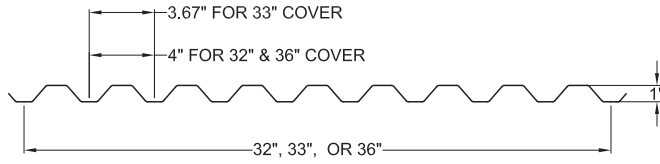

SLAB INFORMATION

Total Slab Depth	Theo. Concrete Volume	
(in.)	(Yd ³ /100 ft ²)	(ft ³ /ft ²)
2 1/2	0.62	0.167
3	0.77	0.208
3 1/2	0.93	0.250
4	1.08	0.292
4 1/2	1.23	0.333
5	1.39	0.375
5 1/2	1.55	0.417

*Volumes and weights do not include allowance for deflection.

ALLOWABLE UNIFORM LOAD (PSF)

TYPE NO.	NO. OF SPANS	DESIGN CRITERIA	CLEAR SPAN (ft-in.)												
			3-0	3-3	3-6	3-9	4-0	4-6	5-0	5-6	6-0	6-6	7-0	7-6	8-0
1.0C26	1	Fb = 36,000	178	152	131	114	100	79	64	53	45	38	33	29	25
		Defl. = l/240	97	77	61	50	41	29	21	16	12	10	8	6	5
		Defl. = l/180	130	102	82	66	55	38	28	21	16	13	10	8	7
	2	Fb = 36,000	185	158	137	119	105	83	67	56	47	40	35	30	26
		Defl. = l/240	240	189	151	123	101	71	52	39	30	24	19	15	13
		Defl. = l/180	320	252	202	164	135	95	69	52	40	31	25	20	17
	3	Fb = 36,000	229	196	170	148	131	103	84	70	59	50	43	38	33
		Defl. = l/240	188	148	118	96	79	56	41	30	23	18	15	12	10
		Defl. = l/180	250	197	158	128	106	74	54	41	31	25	20	16	13
1.0C24	1	Fb = 36,000	261	222	192	167	147	116	94	78	65	56	48	42	37
		Defl. = l/240	139	109	87	71	58	41	30	22	17	14	11	9	7
		Defl. = l/180	185	145	116	95	78	55	40	30	23	18	15	12	10
	2	Fb = 36,000	270	231	199	174	153	121	98	81	68	58	50	44	38
		Defl. = l/240	340	267	214	174	143	101	73	55	42	33	27	22	18
		Defl. = l/180	453	356	285	232	191	134	98	73	57	45	36	29	24
	3	Fb = 36,000	335	287	248	216	190	151	122	101	85	73	63	55	48
		Defl. = l/240	266	209	167	136	112	79	57	43	33	26	21	17	14
		Defl. = l/180	354	279	223	181	149	105	77	58	44	35	28	23	19
1.0C22	1	Fb = 36,000	346	295	254	221	195	154	125	103	86	74	64	55	49
		Defl. = l/240	178	140	112	91	75	53	38	29	22	17	14	11	9
		Defl. = l/180	237	186	149	121	100	70	51	38	30	23	19	15	12
	2	Fb = 36,000	351	300	259	226	199	157	128	106	89	76	65	57	50
		Defl. = l/240	427	336	269	219	180	127	92	69	53	42	34	27	23
		Defl. = l/180	570	448	359	292	240	169	123	92	71	56	45	36	30
	3	Fb = 36,000	435	372	322	281	247	196	159	132	111	94	82	71	62
		Defl. = l/240	334	263	211	171	141	99	72	54	42	33	26	21	18
		Defl. = l/180	446	351	281	228	188	132	96	72	56	44	35	29	24
1.0C20	1	Fb = 36,000	444	379	327	284	250	198	160	132	111	95	82	71	63
		Defl. = l/240	214	168	135	110	90	63	46	35	27	21	17	14	11
		Defl. = l/180	285	224	180	146	120	85	62	46	36	28	22	18	15
	2	Fb = 36,000	431	369	318	278	245	194	157	130	109	93	80	70	62
		Defl. = l/240	515	405	324	264	217	153	111	84	64	51	41	33	27
		Defl. = l/180	687	540	433	352	290	204	148	111	86	68	54	44	36
	3	Fb = 36,000	535	458	396	346	304	241	196	162	136	116	100	87	77
		Defl. = l/240	403	317	254	206	170	119	87	65	50	40	32	26	21
		Defl. = l/180	538	423	339	275	227	159	116	87	67	53	42	34	28

1.3C / 1.3CSV CONFORM DECK

SECTION PROPERTIES

Deck Gauge	Design Thickness	Deck Weight	Section Properties				V _a	F _y
	(in)	(psf)	I _p	I _n	S _p	S _n		
26	0.0179	0.99	0.070	0.069	0.097	0.098	1422	60
24	0.0239	1.33	0.093	0.093	0.132	0.132	2538	60
22	0.0295	1.62	0.115	0.115	0.163	0.162	3518	60
20	0.0358	1.97	0.140	0.140	0.197	0.197	4213	60

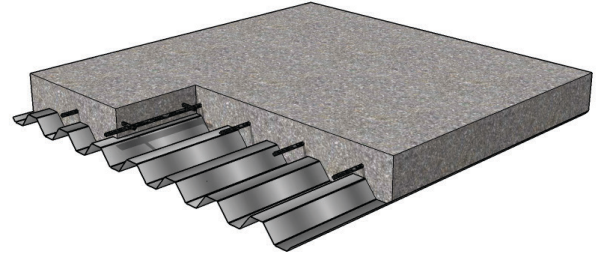

MAXIMUM CONSTRUCTION CLEAR SPANS (S.D.I. CRITERIA) (ft-in.)

Total Slab Depth	Deck	Weight (psf)	NW Concrete N=9 145 PCF			Weight (psf)	LW Concrete N=14 110 PCF		
			1 SPAN	2 SPAN	3 SPAN		1 SPAN	2 SPAN	3 SPAN
3.3 (t=2.00)	1.3C26	33	4'-10	5'-8	5'-9	25	5'-2	6'-2	6'-3
	1.3C24	34	6'-0	7'-1	7'-2	26	6'-6	7'-8	7'-9
	1.3C22	34	6'-5	8'-2	8'-0	26	7'-1	8'-11	8'-9
	1.3C20	34	6'-10	9'-0	8'-6	26	7'-6	9'-10	9'-4
3.8 (t=2.50)	1.3C26	39	4'-8	5'-5	5'-6	30	5'-0	5'-11	6'-0
	1.3C24	40	5'-9	6'-9	6'-10	30	6'-3	7'-4	7'-5
	1.3C22	40	6'-2	7'-9	7'-7	31	6'-9	8'-6	8'-4
	1.3C20	40	6'-6	8'-7	8'-1	31	7'-2	9'-5	8'-10
4.3 (t=3.00)	1.3C26	45	4'-5	5'-3	5'-4	35	4'-10	5'-8	5'-9
	1.3C24	46	5'-6	6'-5	6'-6	35	6'-0	7'-1	7'-2
	1.3C22	46	5'-10	7'-5	7'-3	35	6'-5	8'-2	7'-11
	1.3C20	46	6'-3	8'-2	7'-9	36	6'-10	9'-0	8'-6
4.8 (t=3.50)	1.3C26	51	4'-4	5'-0	5'-1	39	4'-8	5'-6	5'-7
	1.3C24	52	5'-3	6'-2	6'-3	40	5'-9	6'-10	6'-11
	1.3C22	52	5'-8	7'-1	7'-0	40	6'-2	7'-10	7'-8
	1.3C20	52	6'-0	7'-10	7'-5	40	6'-7	8'-8	8'-2
5.3 (t=4.00)	1.3C26	57	4'-2	4'-6	4'-11	44	4'-6	5'-4	5'-5
	1.3C24	58	5'-1	6'-0	6'-1	44	5'-7	6'-7	6'-8
	1.3C22	58	5'-5	6'-10	6'-9	44	6'-0	7'-7	7'-5
	1.3C20	58	5'-10	7'-7	7'-2	45	6'-4	8'-4	7'-10
5.8 (t=4.50)	1.3C26	63	4'-0	4'-1	4'-8	48	4'-5	5'-2	5'-3
	1.3C24	64	4'-11	5'-9	5'-10	49	5'-5	6'-4	6'-5
	1.3C22	64	5'-3	6'-7	6'-6	49	5'-9	7'-4	7'-2
	1.3C20	64	5'-7	7'-3	6'-11	49	6'-2	8'-1	7'-7
6.3 (t=5.00)	1.3C26	69	3'-11	3'-9	4'-3	53	4'-3	4'-11	5'-1
	1.3C24	70	4'-9	5'-7	5'-8	53	5'-3	6'-2	6'-3
	1.3C22	70	5'-1	6'-5	6'-4	54	5'-7	7'-1	6'-11
	1.3C20	70	5'-6	7'-1	6'-9	54	6'-0	7'-10	7'-5

Notes:

1) Minimum exterior bearing length required is 1.5". Minimum interior bearing length is 3".

See page 38 for Reinforced Concrete Slab Allowable Loads for 1.3C Deck.

NON-COMPOSITE

1.3C / 1.3CSV CONFORM DECK

DIMENSIONS

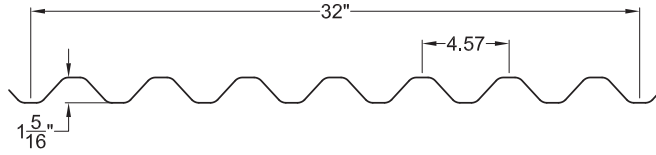

SLAB INFORMATION

Total Slab Depth	Theo. Concrete Volume	
(in.)	(Yd ³ /100 ft ²)	(ft ³ /ft ²)
3.3	0.82	0.221
3.8	0.97	0.263
4.3	1.13	0.304
4.8	1.28	0.346
5.3	1.44	0.388
5.8	1.59	0.429
6.3	1.75	0.471

*Volumes and weights do not include allowance for deflection.

ALLOWABLE UNIFORM LOAD (PSF)

TYPE NO.	NO. OF SPANS	DESIGN CRITERIA	CLEAR SPAN (ft-in.)												
			4-0	4-6	5-0	5-6	6-0	6-6	7-0	7-6	8-0	8-6	9-0	9-6	10-0
1.3C26	1	Fb = 36,000	145	115	93	77	65	55	47	41	36	32	29	26	23
		Defl. = l/240	72	50	37	28	21	17	13	11	9	7	6	5	5
		Defl. = l/180	96	67	49	37	28	22	18	15	12	10	8	7	6
	2	Fb = 36,000	142	113	92	76	64	55	47	41	36	32	29	26	23
		Defl. = l/240	172	121	88	66	51	40	32	26	21	18	15	13	11
		Defl. = l/180	229	161	117	88	68	53	43	35	29	24	20	17	15
	3	Fb = 36,000	175	140	114	95	80	68	59	51	45	40	36	32	29
		Defl. = l/240	134	94	69	52	40	31	25	20	17	14	12	10	9
		Defl. = l/180	179	126	92	69	53	42	33	27	22	19	16	13	11
1.3C24	1	Fb = 36,000	198	156	126	105	88	75	65	56	49	44	39	35	32
		Defl. = l/240	95	67	49	37	28	22	18	14	12	10	8	7	6
		Defl. = l/180	127	89	65	49	38	30	24	19	16	13	11	9	8
	2	Fb = 36,000	194	154	125	103	87	74	64	56	49	44	39	35	32
		Defl. = l/240	230	161	118	88	68	54	43	35	29	24	20	17	15
		Defl. = l/180	306	215	157	118	91	71	57	46	38	32	27	23	20
	3	Fb = 36,000	241	191	155	129	108	93	80	70	61	54	49	44	39
		Defl. = l/240	180	126	92	69	53	42	34	27	22	19	16	13	12
		Defl. = l/180	240	168	123	92	71	56	45	36	30	25	21	18	15
1.3C22	1	Fb = 36,000	244	193	156	129	108	92	80	69	61	54	48	43	39
		Defl. = l/240	118	83	60	45	35	27	22	18	15	12	10	9	8
		Defl. = l/180	157	110	81	61	47	37	29	24	20	16	14	12	10
	2	Fb = 36,000	239	189	154	127	107	91	79	69	60	54	48	43	39
		Defl. = l/240	284	199	145	109	84	66	53	43	36	30	25	21	18
		Defl. = l/180	379	266	194	146	112	88	71	57	47	39	33	28	24
	3	Fb = 36,000	297	236	191	159	133	114	98	86	75	67	60	54	48
		Defl. = l/240	222	156	114	86	66	52	41	34	28	23	20	17	14
		Defl. = l/180	296	208	152	114	88	69	55	45	37	31	26	22	19
1.3C20	1	Fb = 36,000	295	233	189	156	131	112	96	84	74	65	58	52	47
		Defl. = l/240	144	101	74	55	43	33	27	22	18	15	13	11	9
		Defl. = l/180	192	135	98	74	57	45	36	29	24	20	17	14	12
	2	Fb = 36,000	290	230	187	155	130	111	96	84	73	65	58	52	47
		Defl. = l/240	346	243	177	133	102	81	65	52	43	36	30	26	22
		Defl. = l/180	461	324	236	177	137	107	86	70	58	48	40	34	30
	3	Fb = 36,000	361	286	233	193	162	138	120	104	92	81	73	65	59
		Defl. = l/240	271	190	139	104	80	63	50	41	34	28	24	20	17
		Defl. = l/180	361	253	185	139	107	84	67	55	45	38	32	27	23

NON-COMPOSITE

1.5C CONFORM DECK

SECTION PROPERTIES

Deck Gauge	Design Thickness (in)	Deck Weight (psf)	Section Properties				V _a (lbs/ft)	F _y (ksi)
			I _p (in ⁴ /ft)	I _n (in ⁴ /ft)	S _p (in ³ /ft)	S _n (in ³ /ft)		
24	0.0239	1.44	0.136	0.108	0.132	0.120	2508	60
22	0.0295	1.67	0.173	0.139	0.177	0.167	2626	50
20	0.0358	2.03	0.216	0.182	0.226	0.218	3171	50
18	0.0474	2.69	0.286	0.265	0.314	0.298	4160	50

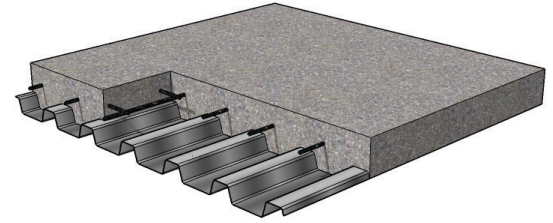

MAXIMUM CONSTRUCTION CLEAR SPANS (S.D.I. CRITERIA) (ft-in.)

Total Slab Depth	Deck	Weight (psf)	NW Concrete N=9 145 PCF			Weight (psf)	LW Concrete N=14 110 PCF		
			1 SPAN	2 SPAN	3 SPAN		1 SPAN	2 SPAN	3 SPAN
3.5 (t=2.00)	1.5C24	37	5'-10	6'-10	6'-11	28	6'-4	7'-6	7'-7
	1.5C22	37	6'-4	7'-4	7'-6	29	6'-10	8'-0	8'-2
	1.5C20	38	7'-5	8'-5	8'-8	29	8'-1	9'-2	9'-6
	1.5C18	38	8'-5	9'-9	10'-1	30	9'-2	10'-8	11'-0
4 (t=2.50)	1.5C24	43	5'-7	6'-6	6'-8	33	6'-1	7'-2	7'-3
	1.5C22	43	6'-0	7'-0	7'-2	33	6'-7	7'-8	7'-10
	1.5C20	44	7'-1	8'-0	8'-3	34	7'-9	8'-9	9'-1
	1.5C18	44	8'-0	9'-4	9'-8	34	8'-9	10'-2	10'-6
4.5 (t=3.00)	1.5C24	49	5'-4	6'-3	6'-4	38	5'-10	6'-10	7'-0
	1.5C22	49	5'-9	6'-8	6'-10	38	6'-4	7'-4	7'-6
	1.5C20	50	6'-9	7'-8	7'-11	38	7'-5	8'-5	8'-8
	1.5C18	50	7'-9	8'-11	9'-3	39	8'-5	9'-10	10'-2
5 (t=3.50)	1.5C24	55	5'-2	6'-0	6'-2	42	5'-8	6'-7	6'-9
	1.5C22	55	5'-7	6'-5	6'-7	42	6'-1	7'-1	7'-3
	1.5C20	56	6'-6	7'-4	7'-7	43	7'-2	8'-1	8'-5
	1.5C18	56	7'-5	8'-7	8'-10	43	8'-2	9'-5	9'-9
5.5 (t=4.00)	1.5C24	61	5'-0	5'-9	5'-11	47	5'-6	6'-5	6'-6
	1.5C22	61	5'-5	6'-2	6'-4	47	5'-11	6'-10	7'-0
	1.5C20	62	6'-3	7'-1	7'-4	47	6'-11	7'-10	8'-1
	1.5C18	62	7'-2	8'-3	8'-6	48	7'-11	9'-2	9'-5
6 (t=4.50)	1.5C24	67	4'-10	5'-7	5'-9	51	5'-4	6'-2	6'-4
	1.5C22	68	5'-3	6'-0	6'-2	52	5'-9	6'-8	6'-10
	1.5C20	68	6'-1	6'-10	7'-1	52	6'-9	7'-7	7'-10
	1.5C18	69	7'-0	8'-0	8'-3	53	7'-8	8'-10	9'-2
6.5 (t=5.00)	1.5C24	73	4'-9	5'-5	5'-7	56	5'-2	6'-0	6'-2
	1.5C22	74	5'-1	5'-9	6'-0	56	5'-7	6'-5	6'-7
	1.5C20	74	5'-11	6'-7	6'-10	57	6'-6	7'-4	7'-7
	1.5C18	75	6'-10	7'-9	8'-0	57	7'-5	8'-7	8'-11

Notes:

- Maximum unshored spans do not consider web crippling. Required bearing should be determined based on allowable reactions on page 43 or with the Vulcraft Unshored Span Calculator available at www.vulcraft.com/designtools. The following conditions are required to meet the maximum unshored spans shown:
 - Minimum exterior bearing length of 1.5" for 24 to 16 gage.
 - Minimum interior bearing length of 2" for 24 to 16 gage.

See page 38 for Reinforced Concrete Slab Allowable Loads for 1.5C Deck.

NON-COMPOSITE

SLAB INFORMATION

Total Slab Depth	Theo. Concrete Volume	
(in.)	(Yd ³ /100 ft ²)	(ft ³ /ft ²)
3 1/2	0.92	0.247
4	1.07	0.289
4 1/2	1.22	0.331
5	1.38	0.372
5 1/2	1.53	0.414
6	1.69	0.456
6 1/2	1.85	0.498

*Volumes and weights do not include allowance for deflection.

1.5C CONFORM DECK

DIMENSIONS

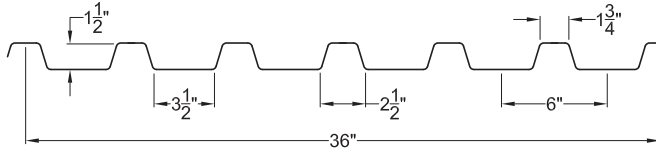

ALLOWABLE UNIFORM LOAD (PSF)

TYPE NO.	NO. OF SPANS	DESIGN CRITERIA	CLEAR SPAN (ft-in.)												
			4-0	4-6	5-0	5-6	6-0	6-6	7-0	7-6	8-0	8-6	9-0	9-6	10-0
1.5C24	1	Fb = 30,000	198	156	126	105	88	75	65	56	49	44	39	35	32
		Defl. = 1/240	140	98	71	54	41	33	26	21	17	15	12	10	9
		Defl. = 1/180	186	131	95	72	55	43	35	28	23	19	16	14	12
	2	Fb = 30,000	177	140	114	94	79	68	58	51	45	40	35	32	29
		Defl. = 1/240	301	212	154	116	89	70	56	46	38	31	26	22	19
		Defl. = 1/180	402	282	206	155	119	94	75	61	50	42	35	30	26
3	Fb = 30,000	220	174	142	117	99	84	73	63	56	49	44	40	36	
	Defl. = 1/240	236	166	121	91	70	55	44	36	29	25	21	18	15	
	Defl. = 1/180	314	221	161	121	93	73	59	48	39	33	28	23	20	
1.5C22	1	Fb = 30,000	221	175	141	117	98	84	72	63	55	49	44	39	35
		Defl. = 1/240	178	125	91	68	53	41	33	27	22	19	16	13	11
		Defl. = 1/180	237	166	121	91	70	55	44	36	30	25	21	18	15
	2	Fb = 30,000	204	162	131	109	92	78	67	59	52	46	41	37	33
		Defl. = 1/240	386	271	198	148	114	90	72	59	48	40	34	29	25
		Defl. = 1/180	514	361	263	198	152	120	96	78	64	54	45	38	33
3	Fb = 30,000	253	201	163	135	114	97	84	73	65	57	51	46	41	
	Defl. = 1/240	302	212	155	116	89	70	56	46	38	31	27	23	19	
	Defl. = 1/180	403	283	206	155	119	94	75	61	50	42	35	30	26	
1.5C20	1	Fb = 30,000	282	223	180	149	125	107	92	80	70	62	56	50	45
		Defl. = 1/240	222	156	113	85	66	52	41	34	28	23	19	17	14
		Defl. = 1/180	295	208	151	114	88	69	55	45	37	31	26	22	19
	2	Fb = 30,000	266	211	172	142	120	102	88	77	68	60	54	48	43
		Defl. = 1/240	491	345	251	189	145	114	92	74	61	51	43	37	31
		Defl. = 1/180	655	460	335	252	194	153	122	99	82	68	57	49	42
3	Fb = 30,000	330	262	213	177	149	127	110	96	84	75	67	60	54	
	Defl. = 1/240	384	270	197	148	114	90	72	58	48	40	34	29	25	
	Defl. = 1/180	512	360	262	197	152	119	96	78	64	53	45	38	33	
1.5C18	1	Fb = 24,000	392	310	251	207	174	148	128	111	98	87	77	69	63
		Defl. = 1/240	294	206	150	113	87	68	55	45	37	31	26	22	19
		Defl. = 1/180	391	275	200	151	116	91	73	59	49	41	34	29	25
	2	Fb = 24,000	363	288	234	194	164	140	121	105	92	82	73	66	59
		Defl. = 1/240	680	478	348	262	202	158	127	103	85	71	60	51	44
		Defl. = 1/180	907	637	464	349	269	211	169	138	113	95	80	68	58
3	Fb = 24,000	449	358	291	241	204	174	150	131	115	102	91	82	74	
	Defl. = 1/240	532	374	273	205	158	124	99	81	67	55	47	40	34	
	Defl. = 1/180	710	498	363	273	210	165	132	108	89	74	62	53	45	

2C CONFORM DECK

SECTION PROPERTIES

Deck Gauge	Design Thickness (in)	Deck Weight (psf)	Section Properties				V _a (lbs/ft)	F _y (ksi)
			I _p (in ⁴ /ft)	I _n (in ⁴ /ft)	S _p (in ³ /ft)	S _n (in ³ /ft)		
22	0.0295	1.56	0.314	0.314	0.244	0.254	1641	50
20	0.0358	1.89	0.403	0.402	0.326	0.337	2419	50
18	0.0474	2.50	0.558	0.558	0.485	0.500	3240	50
16	0.0598	3.16	0.704	0.704	0.653	0.653	3255	40

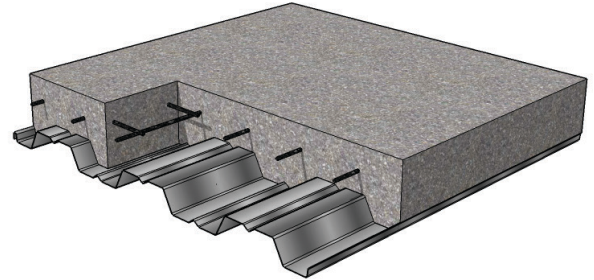

MAXIMUM CONSTRUCTION CLEAR SPANS (S.D.I. CRITERIA) (ft.-in.)

Total Slab Depth	Deck	Weight (psf)	NW Concrete N=9 145 PCF			Weight (psf)	LW Concrete N=14 110 PCF		
			1 SPAN	2 SPAN	3 SPAN		1 SPAN	2 SPAN	3 SPAN
4 (t=2.00)	2C22	38	7'-10	9'-0	9'-3	29	8'-7	9'-10	10'-2
	2C20	39	9'-5	10'-5	10'-9	30	10'-4	11'-4	11'-9
	2C18	39	10'-6	12'-8	12'-6	30	11'-5	13'-9	13'-5
	2C16	40	11'-3	12'-10	13'-3	31	12'-1	14'-0	14'-2
4.5 (t=2.50)	2C22	44	7'-6	8'-7	8'-10	34	8'-2	9'-5	9'-9
	2C20	45	9'-0	9'-11	10'-3	34	9'-11	10'-11	11'-3
	2C18	45	10'-1	12'-1	12'-1	35	11'-0	13'-2	12'-11
	2C16	46	10'-10	12'-3	12'-8	36	11'-8	13'-5	13'-8
5 (t=3.00)	2C22	50	7'-2	8'-3	8'-5	38	7'-10	9'-1	9'-4
	2C20	51	8'-7	9'-6	9'-10	39	9'-6	10'-5	10'-10
	2C18	51	9'-8	11'-6	11'-9	39	10'-7	12'-8	12'-7
	2C16	52	10'-5	11'-9	12'-2	40	11'-4	12'-11	13'-3
5.5 (t=3.50)	2C22	56	6'-10	7'-11	8'-1	43	7'-7	8'-9	8'-11
	2C20	57	8'-3	9'-1	9'-5	43	9'-1	10'-1	10'-5
	2C18	57	9'-4	11'-1	11'-5	44	10'-2	12'-3	12'-3
	2C16	58	10'-0	11'-3	11'-8	45	11'-0	12'-5	12'-10
6 (t=4.00)	2C22	62	6'-7	7'-7	7'-10	48	7'-4	8'-5	8'-8
	2C20	63	7'-11	8'-9	9'-1	48	8'-9	9'-9	10'-1
	2C18	63	9'-0	10'-8	11'-0	49	9'-11	11'-10	11'-11
	2C16	64	9'-9	10'-10	11'-3	49	10'-8	12'-0	12'-5
6.5 (t=4.50)	2C22	68	6'-5	7'-4	7'-6	52	7'-1	8'-2	8'-4
	2C20	69	7'-8	8'-6	8'-9	53	8'-6	9'-5	9'-9
	2C18	69	8'-9	10'-4	10'-8	53	9'-7	11'-5	11'-8
	2C16	70	9'-5	10'-6	10'-10	54	10'-4	11'-8	12'-0
7 (t=5.00)	2C22	74	6'-2	7'-1	7'-4	57	6'-11	7'-11	8'-1
	2C20	75	7'-5	8'-2	8'-6	57	8'-3	9'-2	9'-5
	2C18	75	8'-6	10'-0	10'-4	58	9'-4	11'-1	11'-5
	2C16	76	9'-2	10'-2	10'-6	58	10'-1	11'-4	11'-8

Notes:

1. Maximum unshored spans do not consider web crippling. Required bearing should be determined based on allowable reactions on page 43 or with the Vulcraft Unshored Span Calculator available at www.vulcraft.com/designtools. The following conditions are required to meet the maximum unshored spans shown:

For Normal Weight Concrete:

- Minimum exterior bearing length of 1.5" for 20 to 16 gage. Minimum end bearing varies from 1.5" to 1.875" for 22 gage, depending on slab thickness.
- Minimum interior bearing length of 2" for 19 to 16 gage. Minimum interior bearing varies from 2" to 5.625" for 20 and 22 gage, depending on gage and slab thickness.

For Lightweight Concrete:

- Minimum exterior bearing length of 1.5" for 22 to 16 gage.
- Minimum interior bearing length of 2" for 19 to 16 gage. Minimum interior bearing varies from 2" to 4.25" for 20 to 22 gage, depending on slab thickness.

See page 39 for Reinforced Concrete Slab Allowable Loads for 2C Deck.

NON-COMPOSITE

2C CONFORM DECK

DIMENSIONS

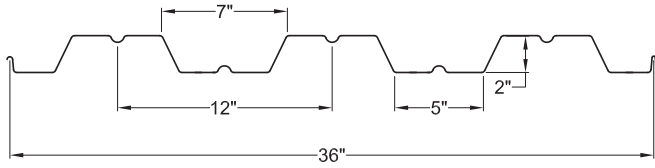

SLAB INFORMATION

Total Slab Depth	Theo. Concrete Volume	
(in.)	(Yd ³ /100 ft ²)	(ft ³ /ft ²)
4	0.93	0.250
4 1/2	1.08	0.292
5	1.23	0.333
5 1/2	1.39	0.375
6	1.54	0.417
6 1/2	1.70	0.458
7	1.86	0.500

*Volumes and weights do not include allowance for deflection.

ALLOWABLE UNIFORM LOAD (PSF)

TYPE NO.	NO. OF SPANS	DESIGN CRITERIA	CLEAR SPAN (ft-in.)												
			5-0	5-6	6-0	6-6	7-0	7-6	8-0	8-6	9-0	9-6	10-0	10-6	11-0
2C22	1	Fb = 30,000	195	161	135	115	100	87	76	67	60	54	49	44	40
		Defl. = 1/240	165	124	95	75	60	49	40	34	28	24	21	18	15
		Defl. = 1/180	220	165	127	100	80	65	54	45	38	32	27	24	21
	2	Fb = 30,000	189	158	134	115	100	87	77	69	61	55	50	45	41
		Defl. = 1/240	397	299	230	181	145	118	97	81	68	58	50	43	37
		Defl. = 1/180	530	398	307	241	193	157	129	108	91	77	66	57	50
	3	Fb = 30,000	230	193	164	142	123	108	95	85	76	68	62	56	51
		Defl. = 1/240	311	234	180	142	113	92	76	63	53	45	39	34	29
		Defl. = 1/180	415	312	240	189	151	123	101	84	71	60	52	45	39
2C20	1	Fb = 30,000	260	215	181	154	133	116	102	90	80	72	65	59	54
		Defl. = 1/240	212	159	122	96	77	63	52	43	36	31	26	23	20
		Defl. = 1/180	282	212	163	128	103	84	69	57	48	41	35	30	26
	2	Fb = 30,000	254	212	180	154	133	117	103	91	82	73	66	60	55
		Defl. = 1/240	509	382	294	232	185	151	124	104	87	74	64	55	48
		Defl. = 1/180	678	510	392	309	247	201	166	138	116	99	85	73	64
	3	Fb = 30,000	311	260	221	190	165	144	127	113	101	91	82	75	68
		Defl. = 1/240	398	299	230	181	145	118	97	81	68	58	50	43	37
		Defl. = 1/180	531	399	307	242	193	157	130	108	91	77	66	57	50
2C18	1	Fb = 30,000	387	320	269	229	198	172	151	134	120	107	97	88	80
		Defl. = 1/240	293	220	170	133	107	87	72	60	50	43	37	32	28
		Defl. = 1/180	391	294	226	178	142	116	95	80	67	57	49	42	37
	2	Fb = 30,000	373	311	264	226	196	172	152	135	120	108	98	89	81
		Defl. = 1/240	705	530	408	321	257	209	172	144	121	103	88	76	66
		Defl. = 1/180	940	706	544	428	343	279	230	191	161	137	118	102	88
	3	Fb = 30,000	453	380	323	278	242	212	187	167	149	134	122	111	101
		Defl. = 1/240	552	415	319	251	201	164	135	112	95	80	69	60	52
		Defl. = 1/180	736	553	426	335	268	218	180	150	126	107	92	79	69
2C16	1	Fb = 24,000	417	345	290	247	213	185	163	144	129	116	104	95	86
		Defl. = 1/240	370	278	214	168	135	110	90	75	63	54	46	40	35
		Defl. = 1/180	493	371	285	225	180	146	120	100	85	72	62	53	46
	2	Fb = 24,000	387	324	275	236	205	179	158	141	126	113	102	93	85
		Defl. = 1/240	891	669	515	405	325	264	217	181	153	130	111	96	84
		Defl. = 1/180	1187	892	687	540	433	352	290	242	204	173	148	128	112
	3	Fb = 24,000	470	395	336	289	252	221	195	174	156	140	127	115	105
		Defl. = 1/240	697	524	403	317	254	207	170	142	120	102	87	75	65
		Defl. = 1/180	929	698	538	423	339	275	227	189	159	135	116	100	87

NON-COMPOSITE

3C CONFORM DECK

SECTION PROPERTIES

Deck Gauge	Design Thickness (in)	Deck Weight (psf)	Section Properties				V _a (lbs/ft)	F _y (ksi)
			I _p (in ⁴ /ft)	I _n (in ⁴ /ft)	S _p (in ³ /ft)	S _n (in ³ /ft)		
22	0.0295	1.71	0.710	0.715	0.387	0.410	1407	50
20	0.0358	2.07	0.907	0.909	0.512	0.538	2485	50
18	0.0474	2.75	1.252	1.252	0.761	0.794	4361	50
16	0.0598	3.47	1.582	1.582	1.013	1.013	4901	40

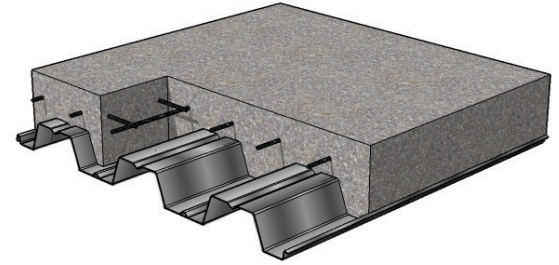

MAXIMUM CONSTRUCTION CLEAR SPANS (S.D.I. CRITERIA) (ft.-in.)

Total Slab Depth	Deck	Weight (psf)	NW Concrete N=9 145 PCF			Weight (psf)	LW Concrete N=14 110 PCF		
			1 SPAN	2 SPAN	3 SPAN		1 SPAN	2 SPAN	3 SPAN
5 (t=2.00)	3C22	44	10'-0	10'-9	11'-1	34	11'-0	11'-10	12'-2
	3C20	44	11'-8	12'-5	12'-10	34	12'-6	13'-8	14'-1
	3C18	45	12'-7	15'-2	14'-9	35	13'-6	16'-7	15'-10
	3C16	46	13'-4	15'-3	15'-7	36	14'-3	16'-8	16'-8
5.5 (t=2.50)	3C22	50	9'-6	9'-11	10'-7	38	10'-7	11'-4	11'-8
	3C20	50	11'-3	11'-11	12'-4	39	12'-2	13'-1	13'-7
	3C18	51	12'-3	14'-6	14'-4	39	13'-1	15'-11	15'-4
	3C16	52	12'-11	14'-7	15'-1	40	13'-10	16'-0	16'-2
6 (t=3.00)	3C22	56	9'-2	9'-2	10'-2	43	10'-2	10'-11	11'-3
	3C20	56	10'-9	11'-5	11'-10	43	11'-10	12'-8	13'-1
	3C18	57	11'-11	13'-11	14'-0	44	12'-9	15'-4	14'-11
	3C16	58	12'-7	14'-0	14'-6	45	13'-6	15'-6	15'-9
6.5 (t=3.50)	3C22	62	8'-9	8'-6	9'-8	48	9'-9	10'-5	10'-10
	3C20	62	10'-4	11'-0	11'-4	48	11'-6	12'-3	12'-7
	3C18	63	11'-8	13'-5	13'-8	49	12'-5	14'-10	14'-7
	3C16	64	12'-4	13'-6	14'-0	49	13'-2	14'-11	15'-5
7 (t=4.00)	3C22	68	8'-6	7'-11	9'-0	52	9'-5	9'-9	10'-6
	3C20	69	10'-0	10'-8	11'-0	52	11'-2	11'-10	12'-3
	3C18	69	11'-5	13'-0	13'-4	53	12'-2	14'-5	14'-3
	3C16	70	12'-1	13'-1	13'-6	54	12'-11	14'-6	15'-0
7.5 (t=4.50)	3C22	74	8'-2	7'-5	8'-6	57	9'-2	9'-3	10'-2
	3C20	75	9'-8	10'-3	10'-7	57	10'-10	11'-6	11'-10
	3C18	75	11'-2	12'-7	13'-0	58	11'-11	14'-0	14'-0
	3C16	76	11'-10	12'-8	13'-1	58	12'-8	14'-1	14'-6
8 (t=5.00)	3C22	80	7'-11	7'-0	8'-0	61	8'-11	8'-8	9'-10
	3C20	81	9'-4	10'-0	10'-4	62	10'-6	11'-2	11'-6
	3C18	81	10'-10	12'-2	12'-7	62	11'-9	13'-7	13'-9
	3C16	82	11'-7	12'-3	12'-8	63	12'-5	13'-8	14'-2

Notes:

1. Maximum unshored spans do not consider web crippling. Required bearing should be determined based on allowable reactions on page 43 or with the Vulcraft Unshored Span Calculator available at www.vulcraft.com/designtools. The following conditions are required to meet the maximum unshored spans shown:

For Normal Weight Concrete:

- Minimum exterior bearing length of 1.5" for 19 to 16 gage. Minimum end bearing varies from 1.5" to 3.75" for 22 and 20 gage, depending on slab thickness.
- Minimum interior bearing length of 2" for 16 gage. Minimum interior bearing varies from 2" to 6.25" for 18 to 22 gage, depending on gage and slab thickness.

For Lightweight Concrete:

- Minimum exterior bearing length of 1.5" for 20 to 16 gage. Minimum end bearing is 1.5" to 2.75" for 22 gage, depending on gage and slab thickness.
- Minimum interior bearing length of 2" for 18 and 16 gage. Minimum end bearing varies from 2" to 6.25" for 22 to 19 gage, depending on gage and slab thickness.

See page 39 for Reinforced Concrete Slab Allowable Loads for 3C.

NON-COMPOSITE

3C CONFORM DECK

DIMENSIONS

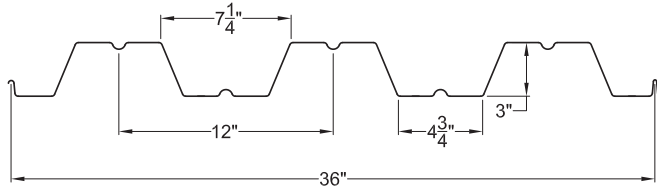

SLAB INFORMATION

Total Slab Depth (in.)	Theo. Concrete Volume	
	(Yd ³ /100 ft ²)	(ft ³ /ft ²)
5	1.08	0.292
5 1/2	1.23	0.333
6	1.39	0.375
6 1/2	1.54	0.417
7	1.70	0.458
7 1/2	1.85	0.500
8	2.01	0.542

*Volumes and weights do not include allowance for deflection.

ALLOWABLE UNIFORM LOAD (PSF)

TYPE NO.	NO. OF SPANS	DESIGN CRITERIA	CLEAR SPAN (ft-in.)												
			6-6	7-0	7-6	8-0	8-6	9-0	9-6	10-0	10-6	11-0	11-6	12-0	12-6
3C22	1	Fb = 30,000	183	158	137	121	107	95	86	77	70	64	58	54	49
		Defl. = 1/240	170	136	110	91	76	64	54	47	40	35	31	27	24
		Defl. = 1/180	226	181	147	121	101	85	72	62	54	47	41	36	32
	2	Fb = 30,000	169	148	131	116	104	94	85	77	70	64	59	54	50
		Defl. = 1/240	410	328	267	220	183	155	131	113	97	85	74	65	58
		Defl. = 1/180	547	438	356	293	245	206	175	150	130	113	99	87	77
	3	Fb = 30,000	201	177	157	140	126	114	103	94	86	79	72	67	62
		Defl. = 1/240	321	257	209	172	144	121	103	88	76	66	58	51	45
		Defl. = 1/180	428	343	279	230	191	161	137	118	102	88	77	68	60
3C20	1	Fb = 30,000	242	209	182	160	141	126	113	102	93	84	77	71	65
		Defl. = 1/240	217	174	141	116	97	82	69	60	51	45	39	34	30
		Defl. = 1/180	289	231	188	155	129	109	93	79	69	60	52	46	41
	2	Fb = 30,000	235	205	180	159	142	127	115	104	94	86	79	73	67
		Defl. = 1/240	523	418	340	280	234	197	167	144	124	108	94	83	73
		Defl. = 1/180	697	558	454	374	312	263	223	191	165	144	126	111	98
	3	Fb = 30,000	284	249	219	194	174	156	141	128	116	106	98	90	83
		Defl. = 1/240	409	328	266	219	183	154	131	112	97	84	74	65	58
		Defl. = 1/180	545	437	355	293	244	205	175	150	129	113	98	87	77
3C18	1	Fb = 30,000	360	310	270	237	210	188	168	152	138	126	115	106	97
		Defl. = 1/240	299	240	195	161	134	113	96	82	71	62	54	48	42
		Defl. = 1/180	399	320	260	214	178	150	128	110	95	82	72	63	56
	2	Fb = 30,000	354	308	270	238	212	190	171	155	141	128	118	108	100
		Defl. = 1/240	721	577	469	387	322	271	231	198	171	149	130	115	101
		Defl. = 1/180	961	769	625	515	430	362	308	264	228	198	173	153	135
	3	Fb = 30,000	433	377	331	293	261	234	211	191	174	159	146	134	124
		Defl. = 1/240	564	452	367	302	252	212	181	155	134	116	102	90	79
		Defl. = 1/180	752	602	489	403	336	283	241	207	178	155	136	120	106
3C16	1	Fb = 24,000	383	330	288	253	224	200	179	162	147	134	122	112	104
		Defl. = 1/240	378	303	246	203	169	142	121	104	90	78	68	60	53
		Defl. = 1/180	504	404	328	270	225	190	161	138	120	104	91	80	71
	2	Fb = 24,000	365	317	277	245	218	195	175	158	144	131	120	111	102
		Defl. = 1/240	910	729	593	488	407	343	292	250	216	188	164	145	128
		Defl. = 1/180	1214	972	790	651	543	457	389	333	288	250	219	193	171
	3	Fb = 24,000	447	389	341	302	269	241	217	196	179	163	150	138	127
		Defl. = 1/240	712	570	464	382	319	268	228	196	169	147	129	113	100
		Defl. = 1/180	950	761	618	510	425	358	304	261	225	196	172	151	134

NON-COMPOSITE

NON-COMPOSITE CONFORM (TYPE "C") SLAB DESIGN

UNDRAPED

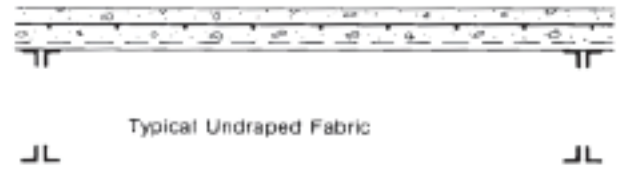
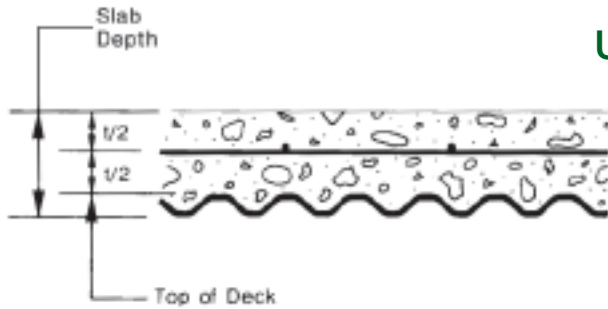

DRAPED

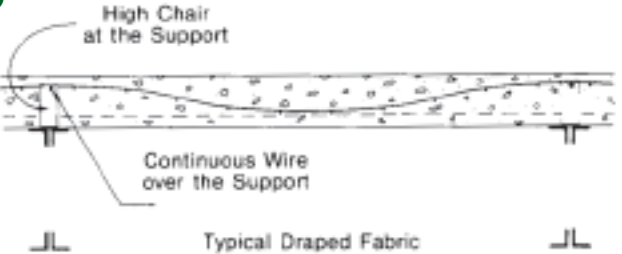
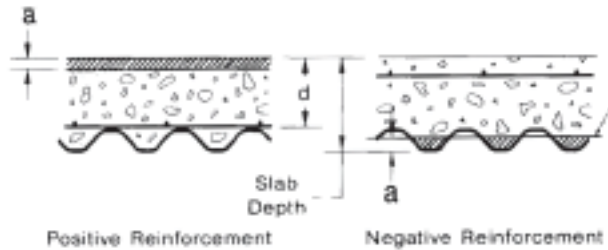

NON-COMPOSITE

Design Notes for Reinforced Concrete Slabs

- Design of concrete slabs in accordance with ACI is the responsibility of the structural engineer of record. Values listed in this catalog are provided as an aid in selecting the appropriate deck and Vulcraft does not assume responsibility for the design of the slab.
- Temperature and shrinkage effects in the concrete shall be controlled by methods permitted by ACI 318. The designer shall be permitted to consider only the area of concrete above the deck.
- Shoring-Slabs temporarily shored during construction must deduct the weight of the slab from the capacity of the reinforced concrete slab.
- Finish-Galvanized form deck can be considered a permanent support in most applications. When uncoated or painted deck is used, the weight of the concrete slab shall be deducted from the calculated capacity of the slab.
- Allowable Slab Loads-These tables are based on an interior three span condition using moment coefficients from ACI 318-14 Section 6.5.2. Moment coefficients must be adjusted for end spans, single spans, or double spans.

$f'_c = 3,000 \text{ psi}$	$\phi = 0.90$	$b = 12 \text{ in}$	$+ M = 1/16W L^2$	$+ M_c = T (d-a/2)/12$
$f_y = 60,000 \text{ psi}$	$T = A_s f_y$	$a = T/0.85 f'_c b$	$- M = 1/12W L^2 (L \leq 10 \text{ ft.})$	$- M_c = T (d-na)/12$
			$- M = 1/10W L^2 (L > 10 \text{ ft.})$	$M_L = \phi M_o/1.6$

- Serviceability-Tabulated values are not evaluated for deflection. Values highlighted in red do not meet the requirements of ACI 318-14 Section 7.3.1 for minimum slab thickness.

REINFORCED CONCRETE SLAB TABLE FOOTNOTES:

- Design of concrete slabs in accordance with ACI is the responsibility of the structural engineer of record. Values listed in this table are provided as an aid in selecting the appropriate deck and Vulcraft does not assume responsibility for the design of the slab.
- Superimposed loads are based upon an three span condition and ACI 318-14 Section 6.5.2 moment coefficients. Load values for single span or double span conditions are to be reduced.
- Deduct weight of slab from table values if deck is not galvanized or if deck is shored during construction.
- The concrete cover thickness (t) for the table values shown meet the ratio of span/28 per ACI 318-14 Section 7.3.1.
- Reinforcing shall be located at center of topping except in shaded areas which require draped mesh.



SLOT VENTS Length = 5/8"
(Type 0.6CSV, 1.0CSV, & 1.3CSV)

VENTING NON-COMPOSITE DECK

0.6C, 1.0C, & 1.3C do not include slot vents in the bottom flute.
Check with plant for availability of sidelap vents

0.6CSV, 1.0CSV, & 1.3CSV are the types of deck that should be specified if slot vents in the bottom flute are required. Check with plant for availability of deck types

REINFORCED CONCRETE SLAB ALLOWABLE LOADS FOR 0.6C DECK

Slab Depth	Reinforcement		Superimposed Uniform Load (psf) -- 3 Span Condition																	
			Clear Span (ft.-in.)																	
	WWF	A _s	2-0	2-3	2-6	2-9	3-0	3-3	3-6	3-9	4-0	4-6	5-0							
2 (t=1.50)	6x6-W2.1xW2.1	0.042	251	198	161	133	112	95	82											
	6x6-W2.9xW2.9	0.058	339	268	217	179	151	128	111											
	6x6-W4.0xW4.0	0.080	400	358	290	240	201	172	148											
2.5 (t=2.00)	6x6-W2.9xW2.9	0.058	400	365	295	244	205	175	151	131	115	91								
	6x6-W4.0xW4.0	0.080	400	400	398	329	276	236	203	177	156	123								
	4x4-W2.9xW2.9	0.087	400	400	400	355	298	254	219	191	168	133								
3 (t=2.50)	6x6-W2.9xW2.9	0.058	400	400	374	309	260	221	191	166	146	115	93							
	6x6-W4.0xW4.0	0.080	400	400	400	400	351	299	258	225	198	156	127							
	4x4-W2.9xW2.9	0.087	400	400	400	400	380	324	279	243	214	169	137							
3.5 (t=3.00)	6x6-W4.0xW4.0	0.080	400	400	400	400	400	400	400	400	400	366	290	235						
	4x4-W2.9xW2.9	0.087	400	400	400	400	400	400	400	400	400	397	314	254						
	4x4-W4.0xW4.0	0.120	400	400	400	400	400	400	400	400	400	400	400	345						
4 (t=3.50)	6x6-W4.0xW4.0	0.080	400	400	400	400	400	400	400	400	400	400	356	289						
	4x4-W2.9xW2.9	0.087	400	400	400	400	400	400	400	400	400	400	386	313						
	4x4-W4.0xW4.0	0.120	400	400	400	400	400	400	400	400	400	400	400	400						
4.5 (t=4.00)	4x4-W2.9xW2.9	0.087	400	400	400	400	400	400	400	400	400	400	400	372						
	4x4-W4.0xW4.0	0.120	400	400	400	400	400	400	400	400	400	400	400	400						
	#3 @ 9" o.c.	0.147	400	400	400	400	400	400	400	400	400	400	400	368						
5 (t=4.50)	4x4-W4.0xW4.0	0.120	400	400	400	400	400	400	400	400	400	400	400	400						
	#3 @ 9" o.c.	0.147	400	400	400	400	400	400	400	400	400	400	400	400						
	#4 @ 12" o.c.	0.196	400	400	400	400	400	400	400	400	400	400	400	400						

REINFORCED CONCRETE SLAB ALLOWABLE LOADS FOR 1.0C DECK

Slab Depth	Reinforcement		Superimposed Uniform Load (psf) -- 3 Span Condition																	
			Clear Span (ft.-in.)																	
	WWF	A _s	3-0	3-3	3-6	3-9	4-0	4-3	4-6	4-9	5-0	5-6	6-0	6-6	7-0	7-6	8-0	8-6	9-0	
2.5 (t=1.50)	6x6-W2.1xW2.1	0.042	112	95	82	71														
	6x6-W2.9xW2.9	0.058	151	128	111	96														
	6x6-W4.0xW4.0	0.080	201	172	148	129														
3 (t=2.00)	6x6-W2.9xW2.9	0.058	205	175	151	131	115	102	91											
	6x6-W4.0xW4.0	0.080	276	236	203	177	156	138	123											
	4x4-W4.0xW4.0	0.120	397	338	292	254	223	198	176											
3.5 (t=2.5)	6x6-W2.9xW2.9	0.058	260	221	191	166	146	129	115	104	93	77								
	6x6-W4.0xW4.0	0.080	351	299	258	225	198	175	156	140	127	105								
	4x4-W4.0xW4.0	0.120	400	400	374	326	287	254	226	203	183	152								
4 (t=3.00)	6x6-W4.0xW4.0	0.080	400	400	400	400	366	325	290	260	235	194	163	139	120					
	4x4-W2.9xW2.9	0.087	400	400	400	400	397	352	314	282	254	210	177	150	130					
	4x4-W4.0xW4.0	0.120	400	400	400	400	400	400	400	383	345	285	240	204	176					
4.5 (t=3.50)	6x6-W4.0xW4.0	0.080	400	400	400	400	400	399	356	320	289	238	200	171	147	128	113			
	4x4-W2.9xW2.9	0.087	400	400	400	400	400	400	386	347	313	259	217	185	160	139	122			
	4x4-W4.0xW4.0	0.120	400	400	400	400	400	400	400	400	352	296	252	218	190	167				
5 (t=4.00)	4x4-W2.9xW2.9	0.087	400	400	400	400	400	400	400	400	372	307	258	220	190	165	145	129	115	
	4x4-W4.0xW4.0	0.120	400	400	400	400	400	400	400	400	400	352	300	259	226	198	176	157		
	#3 @ 9" o.c.	0.147	400	400	400	400	400	400	400	400	368	304	256	218	188	164	144	127	114	
5.5 (t=4.50)	4x4-W4.0xW4.0	0.120	400	400	400	400	400	400	400	400	400	400	348	300	262	230	204	182		
	#3 @ 9" o.c.	0.147	400	400	400	400	400	400	400	400	400	345	290	247	213	186	163	145	129	
	#4 @ 12" o.c.	0.196	400	400	400	400	400	400	400	400	400	400	378	322	278	242	213	188	168	

See page 36 for table footnotes.

REINFORCED CONCRETE SLAB ALLOWABLE LOADS FOR 1.3C DECK

Slab Depth	Reinforcement		Superimposed Uniform Load (psf) -- 3 Span Condition																	
			Clear Span (ft-in.)																	
			WWF	A _s	3-0	3-3	3-6	3-9	4-0	4-3	4-6	4-9	5-0	5-6	6-0	6-6	7-0	7-6	8-0	8-6
3.3 (t=2.00)	6x6-W2.9xW2.9	0.058	205	175	151	131	115	102	91											
	6x6-W4.0xW4.0	0.080	276	236	203	177	156	138	123											
	4x4-W2.9xW2.9	0.087	298	254	219	191	168	149	133											
3.8 (t=2.50)	6x6-W2.9xW2.9	0.058	260	221	191	166	146	129	115	104	93	77								
	6x6-W4.0xW4.0	0.080	351	299	258	225	198	175	156	140	127	105								
	4x4-W2.9xW2.9	0.087	380	324	279	243	214	189	169	152	137	113								
4.3 (t=3.00)	6x6-W4.0xW4.0	0.080	400	400	400	400	400	400	390	350	316	261	219	187	161					
	4x4-W2.9xW2.9	0.087	400	400	400	400	400	400	400	379	342	283	238	203	175					
	4x4-W4.0xW4.0	0.120	400	400	400	400	400	400	400	400	400	386	324	276	238					
4.8 (t=3.50)	6x6-W4.0xW4.0	0.080	400	400	400	400	400	400	400	400	370	305	257	219	189	164	144			
	4x4-W2.9xW2.9	0.087	400	400	400	400	400	400	400	400	400	331	279	237	205	178	157			
	4x4-W4.0xW4.0	0.120	400	400	400	400	400	400	400	400	400	400	381	324	280	244	214			
5.3 (t=4.00)	4x4-W2.9xW2.9	0.087	400	400	400	400	400	400	400	400	400	380	319	272	235	204	180	159	142	
	4x4-W4.0xW4.0	0.120	400	400	400	400	400	400	400	400	400	400	400	372	321	280	246	218	194	
	#3 @ 9" o.c.	0.147	400	400	400	400	400	400	400	400	368	304	256	218	188	164	144	127	114	
5.8 (t=4.50)	4x4-W4.0xW4.0	0.120	400	400	400	400	400	400	400	400	400	400	400	400	362	316	277	246	219	
	#3 @ 9" o.c.	0.147	400	400	400	400	400	400	400	400	400	345	290	247	213	186	163	145	129	
	#4 @ 12" o.c.	0.196	400	400	400	400	400	400	400	400	400	400	378	322	278	242	213	188	168	
6.3 (t=5.00)	4x4-W4.0xW4.0	0.120	400	400	400	400	400	400	400	400	400	400	400	400	352	309	274	244		
	#3 @ 9" o.c.	0.147	400	400	400	400	400	400	400	400	400	386	325	277	239	208	183	162	144	
	#4 @ 12" o.c.	0.196	400	400	400	400	400	400	400	400	400	400	400	361	312	271	239	211	188	

REINFORCED CONCRETE SLAB ALLOWABLE LOADS FOR 1.5C DECK

Slab Depth	Reinforcement		Superimposed Uniform Load (psf) -- 3 Span Condition																	
			Clear Span (ft-in.)																	
			WWF	A _s	2-0	2-6	3-0	3-6	4-0	4-6	5-0	5-6	6-0	6-6	7-0	7-6	8-0	8-6	9-0	9-6
3.5 (t=2.00)	6x6-W2.9xW2.9	0.058	400	295	205	151	115	91												
	6x6-W4.0xW4.0	0.080	400	398	276	203	156	123												
	4x4-W2.9xW2.9	0.087	400	400	298	219	168	133												
4.0 (t=2.50)	6x6-W2.9xW2.9	0.058	400	374	260	191	146	115	93	77										
	6x6-W4.0xW4.0	0.080	400	400	351	258	198	156	127	105										
	4x4-W2.9xW2.9	0.087	400	400	380	279	214	169	137	113										
4.5 (t=3.00)	6x6-W4.0xW4.0	0.080	400	400	400	400	366	290	235	194	163	139	120							
	4x4-W2.9xW2.9	0.087	400	400	400	400	397	314	254	210	177	150	130							
	4x4-W4.0xW4.0	0.120	400	400	400	400	400	345	285	240	204	176								
5.0 (t=3.50)	6x6-W4.0xW4.0	0.080	400	400	400	400	400	356	289	238	200	171	147	128	113					
	4x4-W2.9xW2.9	0.087	400	400	400	400	400	386	313	259	217	185	160	139	122					
	4x4-W4.0xW4.0	0.120	400	400	400	400	400	400	352	296	252	218	190	167						
5.5 (t=4.00)	4x4-W2.9xW2.9	0.087	400	400	400	400	400	400	372	307	258	220	190	165	145	129	115	103		
	4x4-W4.0xW4.0	0.120	400	400	400	400	400	400	400	352	300	259	226	198	176	157	141			
	#3 @ 9" o.c.	0.147	400	400	400	400	400	400	368	304	256	218	188	164	144	127	114	102		
6.0 (t=4.50)	4x4-W4.0xW4.0	0.120	400	400	400	400	400	400	400	400	400	348	300	262	230	204	182	163	147	
	#3 @ 9" o.c.	0.147	400	400	400	400	400	400	400	345	290	247	213	186	163	145	129	116	104	
	#4 @ 12" o.c.	0.196	400	400	400	400	400	400	400	400	378	322	278	242	213	188	168	151	136	
6.5 (t=5.00)	4x4-W4.0xW4.0	0.120	400	400	400	400	400	400	400	400	400	396	342	298	262	232	207	185	167	
	#3 @ 9" o.c.	0.220	400	400	400	400	400	400	400	400	400	400	346	302	265	235	209	188	170	
	#4 @ 12" o.c.	0.400	400	400	400	400	400	400	400	400	400	400	400	400	400	378	351	315	285	

See page 36 for table footnotes.

REINFORCED CONCRETE SLAB ALLOWABLE LOADS FOR 2C DECK

Slab Depth	Reinforcement		Superimposed Uniform Load (psf) -- 3 Span Condition																
			Clear Span (ft-in.)																
	WWF	A _s	2-0	2-6	3-0	3-6	4-0	4-6	5-0	5-6	6-0	6-6	7-0	7-6	8-0	8-6	9-0	9-6	10-0
4.5 (t=2.50)	6x6-W2.9xW2.9	0.058	400	374	260	191	146	115	93	77									
	6x6-W4.0xW4.0	0.080	400	400	351	258	198	156	127	105									
	4x4-W2.9xW2.9	0.087	400	400	380	279	214	169	137	113									
5.0 (t=3.00)	6x6-W2.9xW2.9	0.058	400	400	400	350	268	212	172	142	119	102	88						
	6x6-W4.0xW4.0	0.080	400	400	400	400	366	290	235	194	163	139	120						
	4x4-W2.9xW2.9	0.087	400	400	400	400	397	314	254	210	177	150	130						
5.5 (t=3.50)	6x6-W4.0xW4.0	0.080	400	400	400	400	400	356	289	238	200	171	147	128	113				
	4x4-W2.9xW2.9	0.087	400	400	400	400	400	386	313	259	217	185	160	139	122				
	4x4-W4.0xW4.0	0.120	400	400	400	400	400	400	400	352	296	252	218	190	167				
6.0 (t=4.00)	4x4-W2.9xW2.9	0.087	400	400	400	400	400	400	372	307	258	220	190	165	145	129	115		
	4x4-W4.0xW4.0	0.120	400	400	400	400	400	400	400	400	352	300	259	226	198	176	157		
	#3 @ 9" o.c.	0.147	400	400	400	400	400	400	368	304	256	218	188	164	144	127	114		
6.5 (t=4.50)	4x4-W4.0xW4.0	0.120	400	400	400	400	400	400	400	400	400	348	300	262	230	204	182	163	147
	#3 @ 9" o.c.	0.147	400	400	400	400	400	400	400	345	290	247	213	186	163	145	129	116	104
	#4 @ 12" o.c.	0.196	400	400	400	400	400	400	400	400	378	322	278	242	213	188	168	151	136
7.0 (t=5.00)	4x4-W4.0xW4.0	0.120	400	400	400	400	400	400	400	400	400	396	342	298	262	232	207	185	167
	#3 @ 9" o.c.	0.147	400	400	400	400	400	400	400	386	325	277	239	208	183	162	144	130	117
	#4 @ 12" o.c.	0.196	400	400	400	400	400	400	400	400	400	361	312	271	239	211	188	169	153
7.5 (t=5.50)	4x4-W4.0xW4.0	0.120	400	400	400	400	400	400	400	400	400	400	383	334	293	260	232	208	188
	#3 @ 9" o.c.	0.147	400	400	400	400	400	400	400	400	359	306	264	230	202	179	160	143	129
	#4 @ 12" o.c.	0.196	400	400	400	400	400	400	400	400	400	345	301	264	234	209	187	169	153

REINFORCED CONCRETE SLAB ALLOWABLE LOADS FOR 3C DECK

Slab Depth	Reinforcement		Superimposed Uniform Load (psf) -- 3 Span Condition																
			Clear Span (ft-in.)																
	WWF	A _s	2-0	2-6	3-0	3-6	4-0	4-6	5-0	5-6	6-0	6-6	7-0	7-6	8-0	8-6	9-0	9-6	10-0
5.0 (t=2.00)	6x6-W2.9xW2.9	0.058	400	295	205	151	115	91											
	6x6-W4.0xW4.0	0.080	400	398	276	203	156	123											
	4x4-W2.9xW2.9	0.087	400	400	298	219	168	133											
5.5 (t=2.50)	6x6-W2.9xW2.9	0.058	400	374	260	191	146	115	93	77									
	6x6-W4.0xW4.0	0.080	400	400	351	258	198	156	127	105									
	4x4-W4.0xW4.0	0.120	400	400	400	374	287	226	183	152									
6.0 (t=3.00)	6x6-W4.0xW4.0	0.080	400	400	400	400	366	290	235	194	163	139	120						
	4x4-W2.9xW2.9	0.087	400	400	400	400	397	314	254	210	177	150	130						
	4x4-W4.0xW4.0	0.120	400	400	400	400	400	400	345	285	240	204	176						
6.5 (t=3.50)	6x6-W4.0xW4.0	0.080	400	400	400	400	400	356	289	238	200	171	147	128	113				
	4x4-W2.9xW2.9	0.087	400	400	400	400	400	386	313	259	217	185	160	139	122				
	4x4-W4.0xW4.0	0.120	400	400	400	400	400	400	352	296	252	218	190	167					
7.0 (t=4.00)	4x4-W2.9xW2.9	0.087	400	400	400	400	400	400	372	307	258	220	190	165	145	129	115		
	4x4-W4.0xW4.0	0.120	400	400	400	400	400	400	400	400	352	300	259	226	198	176	157		
	#3 @ 9" o.c.	0.147	400	400	400	400	400	400	368	304	256	218	188	164	144	127	114		
7.5 (t=4.50)	4x4-W4.0xW4.0	0.120	400	400	400	400	400	400	400	400	400	348	300	262	230	204	182	163	147
	#3 @ 9" o.c.	0.147	400	400	400	400	400	400	400	345	290	247	213	186	163	145	129	116	104
	#4 @ 12" o.c.	0.196	400	400	400	400	400	400	400	400	378	322	278	242	213	188	168	151	136
8.0 (t=5.00)	4x4-W4.0xW4.0	0.120	400	400	400	400	400	400	400	400	400	396	342	298	262	232	207	185	167
	#3 @ 9" o.c.	0.147	400	400	400	400	400	400	400	386	325	277	239	208	183	162	144	130	117
	#4 @ 12" o.c.	0.196	400	400	400	400	400	400	400	400	400	361	312	271	239	211	188	169	153

See page 36 for table footnotes.

NON-COMPOSITE DECK FIRE RESISTANCE RATINGS

Restrained Assembly Rating	Type of Protection	Concrete Thickness & Type (1)	U.L. Design No. (2,3)	Type of Form Deck	Unrestrained Beam Rating
1 Hr.	Exposed Grid	2 1/2" NW	G256 +	0.6C, 1.0C, 1.3C, 1.5C	1,2,3 Hr.
	Cementitious	2 1/2" NW&LW	G701	0.6C, 1.0C, 1.3C, 1.5C	1,1.5,2,3 Hr.
			G705	0.6C, 1.0C, 1.3C, 1.5C	1,1.5,2 Hr.
		2 3/4" NW&LW	G702	0.6C, 1.0C, 1.3C, 1.5C	1,1.5,2 Hr.
	Sprayed Fiber	2 1/2" NW&LW	G801	0.6C, 1.0C, 1.3C, 1.5C	1,1.5,2 Hr.
		2 3/4" NW&LW	G802	0.6C, 1.0C, 1.3C, 1.5C	1,1.5,2 Hr.
1 1/2 Hr.	Exposed Grid	2" NW	G229 +	0.6C, 1.0C, 1.3C, 1.5C	1.5,2,3 Hr.
		2 1/2" NW	G228 +	0.6C, 1.0C, 1.3C, 1.5C	1.5,2 Hr.
			G243 +	0.6C, 1.0C, 1.3C, 1.5C	1.5,2 Hr.
		3" NW	G213 +	0.6C, 1.0C, 1.3C, 1.5C	1.5,2,3 Hr.
	Gypsum Board	2" NW&LW	G502 +	0.6C, 1.0C, 1.3C, 1.5C	
	Cementitious	2 1/2" NW&LW	G701	0.6C, 1.0C, 1.3C, 1.5C	1,1.5,2,3 Hr.
			G705	0.6C, 1.0C, 1.3C, 1.5C	1,1.5,2 Hr.
	2 3/4" NW&LW	G702	0.6C, 1.0C, 1.3C, 1.5C	1,1.5,2 Hr.	
		Sprayed Fiber	2 1/2" NW&LW	G801	0.6C, 1.0C, 1.3C, 1.5C
	2 3/4" NW&LW		G802	0.6C, 1.0C, 1.3C, 1.5C	1,1.5,2 Hr.
2 Hr.	Exposed Grid	2 1/2" NW	G227 +	0.6C, 1.0C, 1.3C, 1.5C	3 Hr.
			G228 +	0.6C, 1.0C, 1.3C, 1.5C	1.5,2 Hr.
			G229 +	0.6C, 1.0C, 1.3C, 1.5C	1.5,2,3 Hr.
			G243 +	0.6C, 1.0C, 1.3C, 1.5C	1.5,2 Hr.
			G256 +	0.6C, 1.0C, 1.3C, 1.5C	1,2,3 Hr.
		3" NW	G213 +	0.6C, 1.0C, 1.3C, 1.5C	1.5,2,3 Hr.
	Gypsum Board	2" NW	G505 +	0.6C, 1.0C, 1.3C, 1.5C	
			G529 +	0.6C, 1.0C, 1.3C, 1.5C	2,3 Hr.
		2 1/2" NW	G514 +	0.6C, 1.0C, 1.3C, 1.5C	3 Hr.
			G523 +	0.6C, 1.0C, 1.3C, 1.5C	2 Hr.
	Cementitious	2 1/2" NW&LW	G701	0.6C, 1.0C, 1.3C, 1.5C	1,1.5,2,3 Hr.
			G705	0.6C, 1.0C, 1.3C, 1.5C	1,1.5,2 Hr.
	2 3/4" NW&LW	G702	0.6C, 1.0C, 1.3C, 1.5C	1,1.5,2 Hr.	
		Sprayed Fiber	2 1/2" NW&LW	G801	0.6C, 1.0C, 1.3C, 1.5C
2 3/4" NW&LW	G802		0.6C, 1.0C, 1.3C, 1.5C	1,1.5,2 Hr.	
3 Hr.	Exposed Grid	3 1/4" NW	G229 +	0.6C, 1.0C, 1.3C, 1.5C	1.5,2,3 Hr.
		3 1/2" NW	G213 +	0.6C, 1.0C, 1.3C, 1.5C	1.5,2,3 Hr.
			G256 +	0.6C, 1.0C, 1.3C, 1.5C	1,2,3 Hr.
	Gypsum Board	3 3/4" NW&LW	G529 +	0.6C, 1.0C, 1.3C, 1.5C	3 Hr.
	Cementitious	2 3/4" NW&LW	G701	0.6C, 1.0C, 1.3C, 1.5C	1,1.5,2,3 Hr.
			G705	0.6C, 1.0C, 1.3C, 1.5C	1,1.5,2 Hr.
	Sprayed Fiber	2 3/4" NW&LW	G801	0.6C, 1.0C, 1.3C, 1.5C	1,1.5,2 Hr.

Notes:

- Concrete thickness is thickness of slab above deck, in.
 - Refer to the U.L. "Fire Resistance Directory" for the necessary construction details.
 - Deck finish shall be galvanized unless noted otherwise.
- + Denotes deck finish is not critical when used in G0--, G2-- & G5-- Series designs. Deck finish shall be galvanized or painted.

NON-COMPOSITE

NON-COMPOSITE & COMPOSITE FLOOR DECK CONSTRUCTION LOADING DIAGRAMS PER ANSI/SDI C-2011

FIGURE 1
Loading Diagrams and Bending Moments

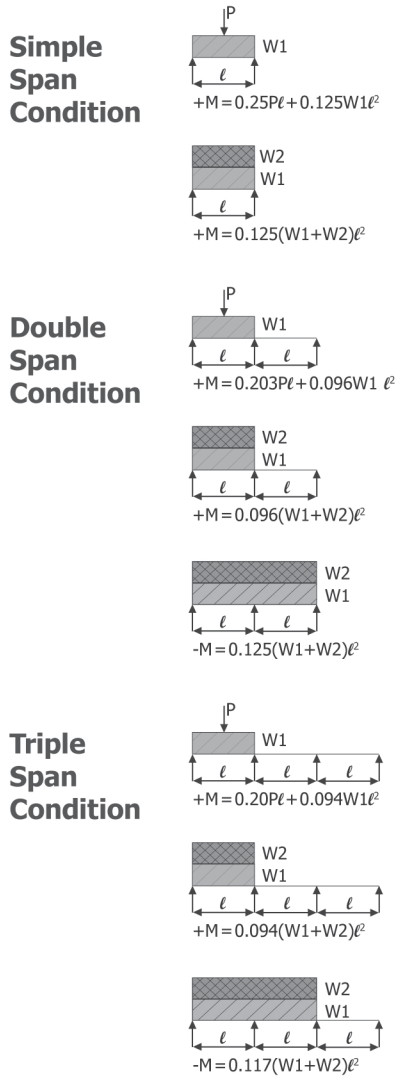

FIGURE 2
Loading Diagrams and Support Reactions

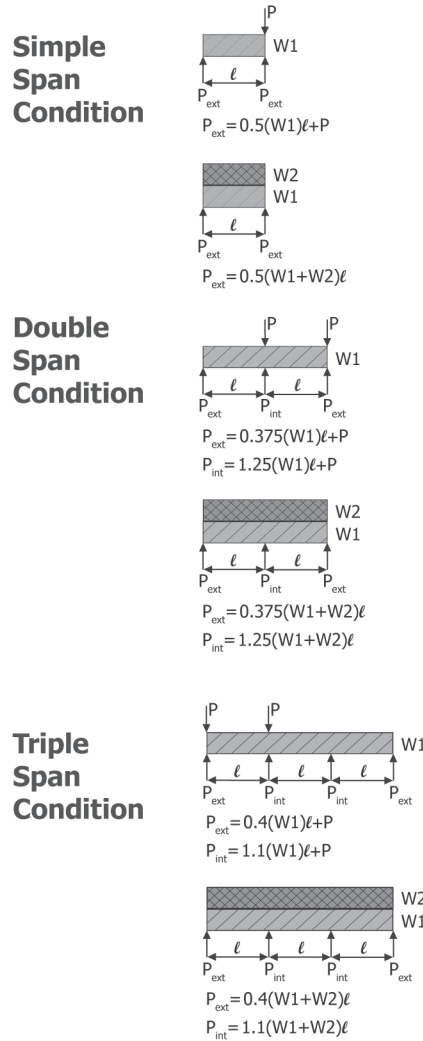
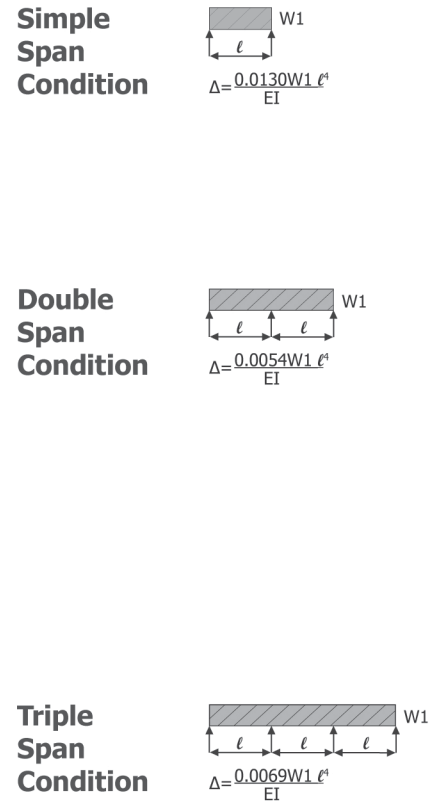

FIGURE 3
Loading Diagrams and Deflections



Notes for Figures 1, 2, and 3

- $P = P_{lc}$ = concentrated construction live load
- I = in^4/ft . (mm^4/m) - deck moment of inertia
- $W_1 = w_{dc} + w_{dd}$ = slab weight + deck weight
- $W_2 = w_{lc}$ = uniform construction live load
- E = 29.5×10^6 psi (203,000 MPa)
- l = clear span length (ft.) (m)

Dimensional consistency requires consistent units when calculating deflections.

Note: Slab weight used in shoring calculations includes an allowance for deck deflection between supports: 3 psf for NW concrete and 2 psf for LW concrete.

WEB CRIPPLING DESIGN EXAMPLE

GIVEN: 3VLI22 deck with a total slab depth of 6 1/2" of normal weight concrete has a span of 7'-7". The end bearing length available is 2 1/2" and the interior bearing length available is 5". From the construction span tables (excerpt below), 3VLI22 with this slab depth can span a 8'-9" in the simple span condition, but since 22 gauge bearing length varies, web crippling must be checked.

CHECK FOR BEARING DESIGN CONDITION: The following checks are performed in accordance with ANSI/SDI C-2011 Standard for Composite Steel Floor Deck-Slabs.

(N = 9.35) NORMAL WEIGHT CONCRETE (145 PCF)

TOTAL SLAB DEPTH	DECK TYPE	SDI Max. Unshored Clear Span			Superimposed Live Load (PSF)														
		1 SPAN	2 SPAN	3 SPAN	Clear Span (ft-in.)														
					7'-0	7'-6	8'-0	8'-6	9'-0	9'-6	10'-0	10'-6	11'-0	11'-6	12'-0	12'-6	13'-0	13'-6	14'-0
6.50 (t=3.50) 63 psf	3VLI22	8'-9	8'-6	9'-8	307	277	251	229	171	155	141	129	118	108	99	91	84	78	72
	3VLI20	10'-4	11'-0	11'-4	343	307	278	253	232	214	198	144	132	121	111	103	95	87	81
	3VLI19	11'-3	12'-4	12'-9	377	337	304	276	252	232	214	199	185	134	123	113	104	96	89
	3VLI18	11'-8	13'-5	13'-8	400	371	338	309	285	264	246	229	215	202	151	140	131	123	115
	3VLI16	12'-4	13'-6	14'-0	400	400	378	345	317	293	272	253	237	222	209	157	146	137	128

Notes:

1. Maximum unshored spans do not consider web crippling. Required bearing should be determined based on allowable reactions on page 43 or with the Vulcraft Unshored Span Calculator available at www.vulcraft.com/designtools. The following conditions are required to meet the maximum unshored spans shown:

- Minimum exterior bearing length of 1.5" for 19 to 16 gage. Minimum end bearing varies from 1.5" to 3.5" for 22 and 20 gage, depending on slab thickness.
- Minimum interior bearing length of 2" for 16 gage. Minimum interior bearing varies from 2" to 6.25" for 18 to 22 gage, depending on gage and slab thickness.

3VLI22

Span: 7.5833 ft	W1: 65.1 psf
R _{a-ext} : 419 plf	W2: 20 psf
R _{a-int} : 844 plf	P: 150 plf
Single Span	
P _{ext} = 397 plf	plf <= R _{a-ext} okay
P _{ext} = 323 plf	plf <= R _{a-ext} okay
Double Span	
P _{ext} = 335 plf	plf <= R _{a-ext} okay
P _{ext} = 242 plf	plf <= R _{a-ext} okay
P _{int} = 767 plf	plf <= R _{a-int} okay
P _{int} = 807 plf	plf <= R _{a-int} okay
Triple Span	
P _{ext} = 347 plf	plf <= R _{a-ext} okay
P _{ext} = 258 plf	plf <= R _{a-ext} okay
P _{int} = 693 plf	plf <= R _{a-int} okay
P _{int} = 710 plf	plf <= R _{a-int} okay

$$W1 = W_{conc} + W_{deck} + 3 \text{ psf (NW) or } 2 \text{ psf (LW)}$$

Therefore, the deck is satisfactory for the project details noted above.

NON-COMPOSITE & COMPOSITE DECK WEB CRIPPLING

1.5C/1.5VLI/1.5VLR		Allowable Reaction, (lbs/ft)								
Deck Gauge	Reaction Type	One Flange Loading								
		Bearing Length (in.)								
		1.5	2	2.5	3	3.5	4	4.5	5	6
22	Exterior	818	899	971	1035	1095	1121	1121	1121	1121
	Interior	1222	1325	1417	1499	1575	1609	1609	1609	1609
20	Exterior	1168	1280	1378	1467	1549	1582	1582	1582	1582
	Interior	1768	1912	2038	2152	2257	2299	2299	2299	2299
19	Exterior	1552	1696	1823	1938	2043	2081	2081	2081	2081
	Interior	2375	2560	2723	2871	3007	3056	3056	3056	3056
18	Exterior	1955	2132	2288	2428	2558	2600	2600	2600	2600
	Interior	3016	3244	3444	3626	3793	3847	3847	3847	3847
16	Exterior	2397	2603	2784	2948	3099	3136	3136	3136	3136
	Interior	3750	4017	4252	4464	4660	4707	4707	4707	4707

2C/2VLI		Allowable Reaction, (lbs/ft)								
Deck Gauge	Reaction Type	One Flange Loading								
		Bearing Length (in.)								
		1.5	2	2.5	3	3.5	4	4.5	5	6
22	Exterior	363	399	431	460	486	511	534	556	596
	Interior	570	618	661	699	735	767	798	828	882
20	Exterior	522	572	616	655	692	726	758	788	844
	Interior	825	892	951	1004	1053	1098	1141	1182	1257
19	Exterior	696	761	818	869	916	960	1002	1041	1114
	Interior	1108	1195	1271	1340	1403	1462	1517	1570	1667
18	Exterior	879	959	1029	1092	1151	1205	1256	1304	1393
	Interior	1407	1514	1608	1692	1770	1843	1911	1975	2095
16	Exterior	1083	1176	1258	1333	1401	1464	1524	1580	1685
	Interior	1750	1875	1985	2084	2175	2260	2340	2415	2555

3C/3VLI		Allowable Reaction, (lbs/ft)								
Deck Gauge	Reaction Type	One Flange Loading								
		Bearing Length (in.)								
		1.5	2	2.5	3	3.5	4	4.5	5	6
22	Exterior	353	388	419	447	472	496	518	540	579
	Interior	581	631	674	713	749	783	815	844	900
20	Exterior	510	559	602	640	676	709	741	770	825
	Interior	842	910	970	1025	1075	1121	1165	1206	1283
19	Exterior	683	747	803	853	899	943	983	1022	1093
	Interior	1131	1219	1297	1368	1432	1492	1549	1602	1702
18	Exterior	866	944	1013	1075	1133	1186	1236	1284	1372
	Interior	1437	1545	1641	1728	1807	1881	1951	2017	2139
16	Exterior	1071	1164	1245	1318	1386	1449	1508	1563	1667
	Interior	1787	1914	2026	2127	2221	2307	2389	2466	2609

NON-COMPOSITE

COMPOSITE



NON-COMPOSITE & COMPOSITE FLOOR DECK SDI POUR STOP SELECTION TABLE PER ANSI/SDI NC1.0 ATTACHMENT NC2 AND C-2011

NON-COMPOSITE

COMPOSITE

SLAB DEPTH (INCHES)	SLAB DEPTH (mm)	OVERHANG - INCHES (mm)												
		0	1	2	3	4	5	6	7	8	9	10	11	12
		0	25	51	76	102	127	152	178	203	229	254	279	305
		POUR STOP TYPES												
4.00	102	20	20	20	20	18	18	16	14	12	12	12	10	10
4.25	108	20	20	20	18	18	16	16	14	12	12	12	10	10
4.50	114	20	20	20	18	18	16	16	14	12	12	12	10	10
4.75	121	20	20	18	18	16	16	14	14	12	12	10	10	10
5.00	127	20	20	18	18	16	16	14	14	12	12	10	10	
5.25	133	20	18	18	16	16	14	14	12	12	12	10	10	
5.50	140	20	18	18	16	16	14	14	12	12	12	10	10	
5.75	146	20	18	16	16	14	14	12	12	12	12	10	10	
6.00	152	18	18	16	16	14	14	12	12	12	10	10	10	
6.25	159	18	18	16	14	14	12	12	12	12	10	10		
6.50	165	18	16	16	14	14	12	12	12	12	10	10		
6.75	171	18	16	14	14	14	12	12	12	10	10	10		
7.00	178	18	16	14	14	12	12	12	12	10	10	10		
7.25	184	16	16	14	14	12	12	12	10	10	10			
7.50	191	16	14	14	12	12	12	12	10	10	10			
7.75	197	16	14	14	12	12	12	10	10	10	10			
8.00	203	14	14	12	12	12	12	10	10	10				
8.25	210	14	14	12	12	12	10	10	10	10				
8.50	216	14	12	12	12	12	10	10	10					
8.75	222	14	12	12	12	12	10	10	10					
9.00	229	14	12	12	12	10	10	10						
9.25	235	12	12	12	12	10	10	10						
9.50	241	12	12	12	10	10	10							
9.75	248	12	12	12	10	10	10							
10.00	254	12	12	10	10	10	10							
10.25	260	12	12	10	10	10								
10.50	267	12	12	10	10	10								
10.75	273	12	10	10	10									
11.00	279	12	10	10	10									
11.25	286	12	10	10										
11.50	292	10	10	10										
11.75	298	10	10											
12.00	305	10	10											

TYPES	DESIGN THICKNESS (INCHES)	DESIGN THICKNESS (mm)
20	0.0358	0.91
18	0.0474	1.20
16	0.0598	1.52
14	0.0747	1.90
12	0.1046	2.66
10	0.1345	3.42

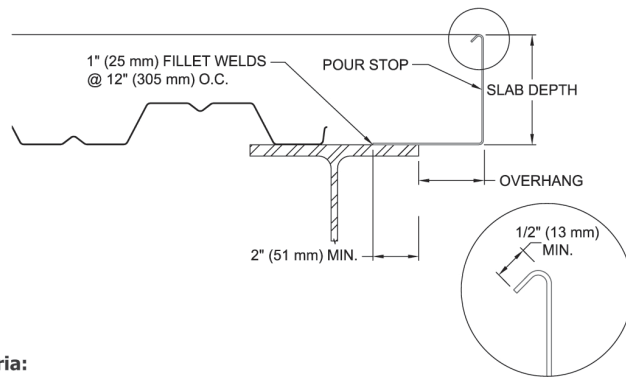

NOTES: This Selection Chart is based on the following criteria:

1. Normal weight concrete 150 PCF (2,400 kg/m³).
2. Horizontal and vertical deflection is limited to 1/4" (6.3mm) maximum for concrete dead load.
3. Design stress is limited to 20 KSI (138 MPa) for concrete dead load temporarily increased by one-third for the construction live load of 20 PSF (0.96 kPa).
4. Pour Stop Selection Chart does not consider the effect of the performance, deflection, or rotation of the pour stop support which may include both the supporting deck and/or the frame.
5. Vertical leg return lip is recommended for all types (gages).
6. This selection table is not meant to replace the judgment of experienced structural engineers and should be considered as a reference only.

NON-COMPOSITE & COMPOSITE DECK DETAILS

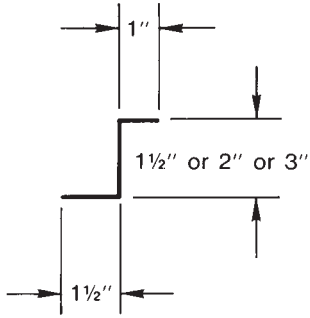

"Z" Closure



Hanger Tab
Max. Load
60 lbs. per Tab
#12 Wire Minimum

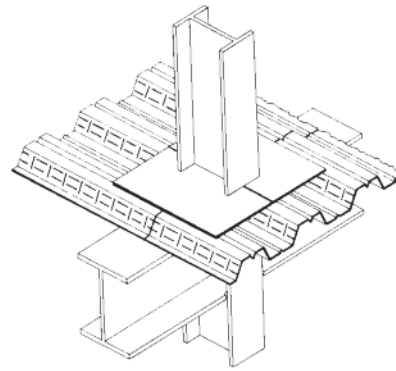

COLUMN CLOSURE

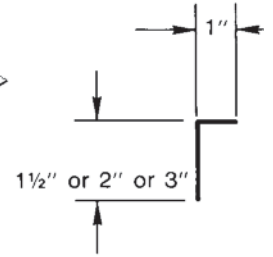

Cell Closure

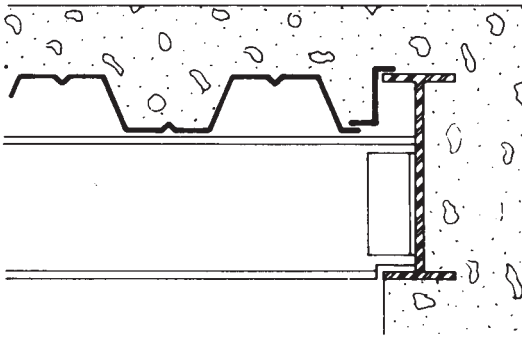

"z" CLOSURE

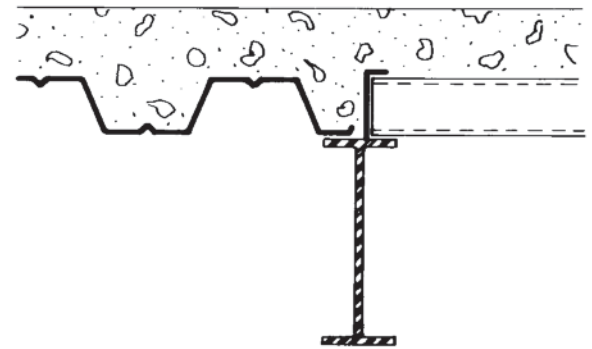

CELL CLOSURE

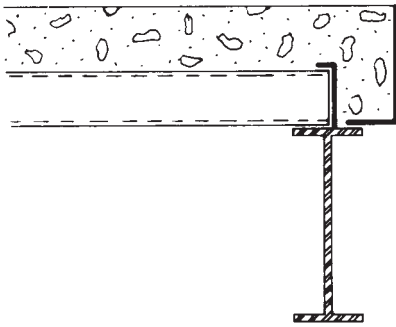

POUR STOP AT END

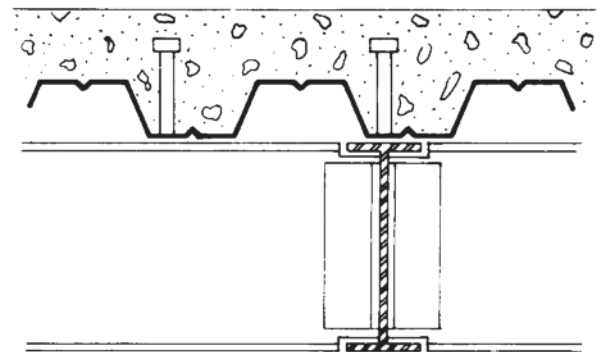

STUD LOCATIONS

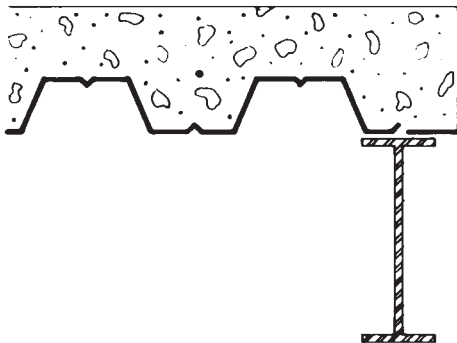

POUR STOP AT SIDE

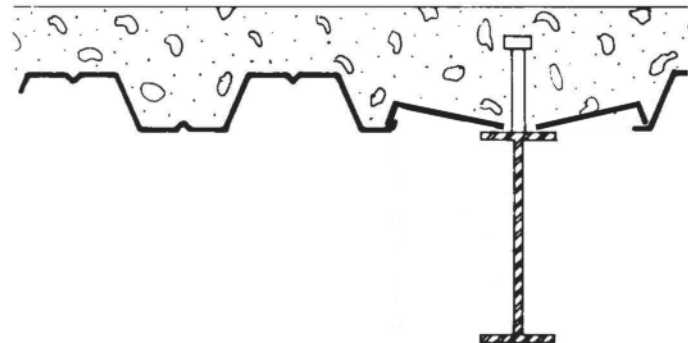

GIRDER FILLER

NON-COMPOSITE

COMPOSITE

1.5VL / 1.5VLI COMPOSITE DECK

SECTION PROPERTIES

Deck Gauge	Design Thickness (in.)	Deck Weight (psf)	Section Properties				V _a (lbs/ft)	F _y (ksi)
			I _p (in ⁴ /ft)	S _p (in ³ /ft)	I _n (in ⁴ /ft)	S _n (in ³ /ft)		
22	0.0295	1.67	0.139	0.167	0.173	0.177	2626	50
20	0.0358	2.03	0.182	0.218	0.216	0.226	3171	50
19	0.0418	2.37	0.224	0.259	0.252	0.275	3685	50
18	0.0474	2.69	0.265	0.298	0.286	0.314	4160	50
16	0.0598	3.40	0.362	0.389	0.362	0.396	4156	40

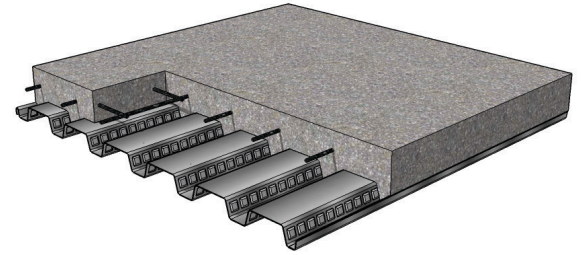

(N = 9.35) NORMAL WEIGHT CONCRETE (145 PCF)

TOTAL SLAB DEPTH	DECK TYPE	SDI Max. Unshored Clear Span			Superimposed Live Load (PSF)															
		1 SPAN	2 SPAN	3 SPAN	Clear Span (ft-in.)															
					5'-0	5'-6	6'-0	6'-6	7'-0	7'-6	8'-0	8'-6	9'-0	9'-6	10'-0	10'-6	11'-0	11'-6	12'-0	
3.50 (t=2.00) 33 psf	1.5VL22	6'-4	7'-5	7'-6	314	279	250	206	186	169	154	141	130	120	111	100	87	76	67	
	1.5VL20	7'-7	8'-10	9'-0	345	306	275	249	227	208	171	157	144	134	124	108	94	82	73	
	1.5VL19	8'-1	9'-10	10'-0	372	330	296	268	244	224	207	171	157	146	134	116	101	88	78	
	1.5VL18	8'-7	10'-6	10'-9	395	351	315	285	260	238	220	204	168	156	142	123	107	94	82	
	1.5VL16	9'-5	10'-5	10'-10	397	353	316	286	261	239	221	205	190	156	145	135	119	104	92	
4.00 (t=2.50) 39 psf	1.5VL22	6'-0	7'-0	7'-2	366	325	291	240	216	196	179	164	151	139	129	119	111	103	96	
	1.5VL20	7'-2	8'-5	8'-6	400	356	319	289	263	217	198	182	167	155	143	133	124	115	108	
	1.5VL19	7'-8	9'-4	9'-6	400	383	344	311	283	260	215	197	182	168	156	145	135	126	115	
	1.5VL18	8'-1	9'-11	10'-2	400	400	365	330	301	276	254	211	195	180	167	156	145	136	122	
	1.5VL16	9'-0	9'-11	10'-3	400	400	365	330	301	276	255	236	220	180	167	155	145	136	127	
4.50 (t=3.00) 45 psf	1.5VL22	5'-9	6'-9	6'-10	400	373	307	275	248	225	205	188	173	159	147	137	127	118	109	
	1.5VL20	6'-10	8'-0	8'-1	400	400	366	331	274	249	227	208	192	177	164	152	142	132	123	
	1.5VL19	7'-4	8'-11	9'-1	400	400	393	356	325	269	246	226	208	193	179	166	155	145	135	
	1.5VL18	7'-9	9'-6	9'-9	400	400	400	378	344	316	262	241	222	206	191	178	166	155	145	
	1.5VL16	8'-7	9'-6	9'-10	400	400	400	377	344	315	291	270	222	205	190	177	165	155	145	
5.00 (t=3.50) 51 psf	1.5VL22	5'-6	6'-6	6'-6	400	400	347	311	280	255	232	213	195	180	167	154	143	133	124	
	1.5VL20	6'-7	7'-8	7'-9	400	400	400	375	310	281	257	236	217	200	186	172	160	149	139	
	1.5VL19	7'-1	8'-6	8'-8	400	400	400	400	367	304	278	255	235	218	202	188	175	163	153	
	1.5VL18	7'-6	9'-1	9'-4	400	400	400	400	389	357	297	272	251	233	216	201	187	175	164	
	1.5VL16	8'-2	9'-1	9'-5	400	400	400	400	388	356	328	271	250	232	215	200	187	175	164	
5.50 (t=4.00) 57 psf	1.5VL22	5'-4	6'-3	6'-4	400	400	388	348	314	285	260	238	219	202	186	173	160	149	138	
	1.5VL20	6'-4	7'-5	7'-6	400	400	400	383	346	315	287	263	243	224	208	193	179	167	156	
	1.5VL19	6'-10	8'-2	8'-4	400	400	400	400	374	340	311	286	263	243	226	210	196	183	171	
	1.5VL18	7'-3	8'-9	9'-0	400	400	400	400	400	363	332	305	281	260	241	225	210	196	183	
	1.5VL16	7'-10	8'-9	9'-0	400	400	400	400	400	398	330	303	280	259	240	224	209	195	183	
6.00 (t=4.50) 63 psf	1.5VL22	5'-2	6'-0	6'-1	400	400	400	385	348	315	288	263	242	223	207	191	178	165	153	
	1.5VL20	6'-1	7'-2	7'-3	400	400	400	400	383	348	318	292	269	248	230	214	199	185	173	
	1.5VL19	6'-7	7'-11	8'-0	400	400	400	400	400	377	344	316	291	270	250	233	217	202	189	
	1.5VL18	7'-0	8'-5	8'-9	400	400	400	400	400	400	367	337	311	288	267	249	232	217	203	
	1.5VL16	7'-7	8'-5	8'-9	400	400	400	400	400	400	365	336	310	286	266	248	231	216	202	

Notes:

- Maximum unshored spans do not consider web crippling. Required bearing should be determined based on allowable reactions on page 43 or with the Vulcraft Unshored Span Calculator available at www.vulcraft.com/designtools. The following conditions are required to meet the maximum unshored spans shown:
 - Minimum exterior bearing length of 1.5" for 22 to 16 gage.
 - Minimum interior bearing length of 2" for 22 to 16 gage.
- Always contact Vulcraft when using loads in excess of 200 psf. Such loads often result from concentrated, dynamic or "long term" load cases for which reductions due to bond breakage, concrete creep etc. should be evaluated.
- All fire rated assemblies are subject to an upper live load limit of 250 psf.

1.5VL / 1.5VLI COMPOSITE DECK

DIMENSIONS

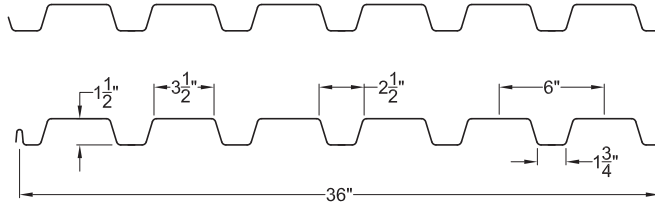

SLAB INFORMATION

Total Slab Depth (in.)	Theo. Concrete Volume (Yd ³ /100 ft ²)	(ft ³ /ft ²)	Recommended Welded Wire Fabric
3 1/2	0.78	0.211	6x6 - W1.4xW1.4
4	0.94	0.253	6x6 - W1.4xW1.4
4 1/2	1.09	0.294	6x6 - W1.4xW1.4
4 3/4	1.17	0.315	6x6 - W1.4xW1.4
5	1.24	0.336	6x6 - W2.1xW2.1
5 1/2	1.4	0.378	6x6 - W2.1xW2.1
5 3/4	1.48	0.398	6x6 - W2.1xW2.1
6	1.55	0.419	6x6 - W2.1xW2.1

*Volumes and weights do not include allowance for deflection.

(N = 14.15) LIGHT WEIGHT CONCRETE (110 PCF)

TOTAL SLAB DEPTH	DECK TYPE	SDI Max. Unshored Clear Span			Superimposed Live Load (PSF)															
		1 SPAN	2 SPAN	3 SPAN	Clear Span (ft-in.)															
					5'-0	5'-6	6'-0	6'-6	7'-0	7'-6	8'-0	8'-6	9'-0	9'-6	10'-0	10'-6	11'-0	11'-6	12'-0	
3.50 (t=2.00) 25 psf	1.5VL22	6'-10	8'-0	8'-2	278	247	222	200	167	152	139	124	105	89	76	66	57	50	44	
	1.5VL20	8'-3	9'-8	9'-10	305	271	243	220	201	184	162	135	114	97	83	72	62	54	48	
	1.5VL19	8'-10	10'-8	11'-0	329	292	262	237	216	198	173	144	122	104	89	77	67	58	51	
	1.5VL18	9'-4	11'-4	11'-7	350	311	279	252	230	211	184	153	129	110	94	81	71	62	54	
	1.5VL16	10'-3	11'-4	11'-8	352	312	280	253	231	212	195	171	144	122	105	91	79	69	61	
4.00 (t=2.50) 30 psf	1.5VL22	6'-6	7'-8	7'-9	324	288	258	233	194	177	161	148	137	126	113	98	85	75	66	
	1.5VL20	7'-10	9'-2	9'-4	355	315	283	256	233	214	178	164	151	140	123	106	92	81	71	
	1.5VL19	8'-5	10'-2	10'-5	382	339	304	275	251	230	212	178	164	152	131	113	99	86	76	
	1.5VL18	8'-11	10'-10	11'-1	400	360	323	292	266	244	225	209	175	162	139	120	104	91	80	
	1.5VL16	9'-9	10'-10	11'-2	400	360	323	292	266	244	225	209	195	180	151	134	116	102	90	
4.50 (t=3.00) 35 psf	1.5VL22	6'-3	7'-4	7'-5	372	330	296	247	223	203	185	170	157	145	134	125	116	106	93	
	1.5VL20	7'-6	8'-10	8'-11	400	361	324	293	267	245	204	188	173	160	149	139	129	114	101	
	1.5VL19	8'-1	9'-9	10'-0	400	388	348	315	287	264	243	203	188	174	162	151	139	122	107	
	1.5VL18	8'-6	10'-5	10'-8	400	400	369	334	305	279	258	239	200	186	173	161	147	129	114	
	1.5VL16	9'-4	10'-5	10'-9	400	400	369	334	304	279	257	239	222	185	172	160	150	140	126	
4.75 (t=3.25) 37 psf	1.5VL22	6'-2	7'-3	7'-4	396	352	316	263	237	216	197	181	167	154	143	133	124	115	108	
	1.5VL20	7'-4	8'-8	8'-9	400	385	345	312	285	238	218	200	185	171	159	148	138	129	118	
	1.5VL19	7'-11	9'-7	9'-9	400	400	371	336	306	281	236	217	200	185	172	160	150	140	126	
	1.5VL18	8'-4	10'-2	10'-5	400	400	393	356	324	298	274	231	213	198	184	171	160	150	133	
	1.5VL16	9'-2	10'-2	10'-6	400	400	392	355	324	297	274	254	236	197	183	171	160	149	140	
5.00 (t=3.5) 39 psf	1.5VL22	6'-0	7'-1	7'-2	400	374	335	279	252	229	209	192	177	164	152	141	131	123	115	
	1.5VL20	7'-3	8'-6	8'-7	400	400	367	332	302	253	231	212	196	181	168	157	146	137	128	
	1.5VL19	7'-9	9'-5	9'-7	400	400	394	356	325	298	250	230	212	197	183	170	159	149	140	
	1.5VL18	8'-2	10'-0	10'-3	400	400	400	378	344	316	291	245	226	210	195	182	170	159	150	
	1.5VL16	9'-0	10'-0	10'-4	400	400	400	377	343	315	291	269	251	209	194	181	169	159	149	
5.75 (t=4.25) 46 psf	1.5VL22	5'-9	6'-9	6'-10	400	400	367	329	297	270	247	227	209	193	179	166	155	145	135	
	1.5VL20	6'-10	8'-0	8'-1	400	400	400	391	327	298	273	250	231	214	199	185	172	161	151	
	1.5VL19	7'-4	8'-11	9'-0	400	400	400	400	383	322	295	271	250	232	215	201	187	175	165	
	1.5VL18	7'-9	9'-6	9'-9	400	400	400	400	400	372	314	289	267	247	230	214	200	188	176	
	1.5VL16	8'-6	9'-6	9'-10	400	400	400	400	400	371	342	317	265	246	229	213	199	187	175	

Notes:

1. Maximum unshored spans do not consider web crippling. Required bearing should be determined based on allowable reactions on page 43 or with the Vulcraft Unshored Span Calculator available at www.vulcraft.com/designtools. The following conditions are required to meet the maximum unshored spans shown:

- Minimum exterior bearing length of 1.5" for 22 to 16 gage.
- Minimum interior bearing length of 2" for 22 to 16 gage.

2. Always contact Vulcraft when using loads in excess of 200 psf. Such loads often result from concentrated, dynamic or "long term" load cases for which reductions due to bond breakage, concrete creep etc. should be evaluated.

3. All fire rated assemblies are subject to an upper live load limit of 250 psf.

1.5VLR COMPOSITE DECK

SECTION PROPERTIES

Deck Gauge	Design Thickness (in.)	Deck Weight (psf)	Section Properties				V _a (lbs/ft)	F _y (ksi)
			I _p (in ⁴ /ft)	S _p (in ³ /ft)	I _n (in ⁴ /ft)	S _n (in ³ /ft)		
22	0.0295	1.67	0.173	0.177	0.139	0.167	2626	50
20	0.0358	2.03	0.216	0.226	0.182	0.218	3171	50
19	0.0418	2.37	0.252	0.275	0.224	0.259	3685	50
18	0.0474	2.69	0.286	0.314	0.265	0.298	4160	50
16	0.0598	3.40	0.362	0.396	0.362	0.389	4156	40

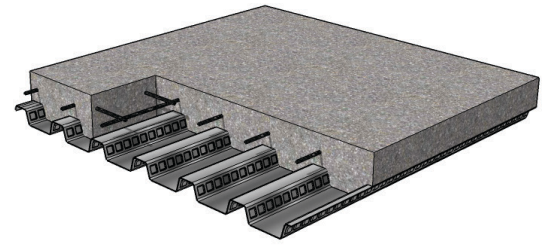

(N = 9.35) NORMAL WEIGHT CONCRETE (145 PCF)

TOTAL SLAB DEPTH	DECK TYPE	SDI Max. Unshored Clear Span			Superimposed Live Load (PSF)															
		1 SPAN	2 SPAN	3 SPAN	Clear Span (ft-in.)															
					5'-0	5'-6	6'-0	6'-6	7'-0	7'-6	8'-0	8'-6	9'-0	9'-6	10'-0	10'-6	11'-0	11'-6	12'-0	
3.50 (t=2.00) 38 psf	1.5VLR22	6'-4	7'-4	7'-6	314	279	250	203	183	166	151	138	127	117	108	100	92	86	77	
	1.5VLR20	7'-5	8'-5	8'-8	345	306	275	249	227	184	168	154	141	130	120	112	104	94	83	
	1.5VLR19	8'-1	9'-1	9'-5	372	330	296	268	244	224	207	167	154	142	132	122	114	100	88	
	1.5VLR18	8'-5	9'-9	10'-1	395	351	315	285	260	238	220	179	165	153	141	131	119	105	92	
	1.5VLR16	9'-0	9'-11	10'-3	397	353	316	286	261	239	221	205	190	153	142	132	123	115	101	
4.00 (t=2.50) 44 psf	1.5VLR22	6'-0	7'-0	7'-2	366	325	291	236	213	193	176	161	148	136	125	116	108	100	93	
	1.5VLR20	7'-1	8'-0	8'-3	400	356	319	289	263	214	195	179	164	151	140	130	121	112	105	
	1.5VLR19	7'-8	8'-8	9'-0	400	383	344	311	283	260	212	194	179	165	153	142	132	123	115	
	1.5VLR18	8'-0	9'-4	9'-8	400	400	365	330	301	276	254	208	191	177	164	152	142	132	124	
	1.5VLR16	8'-8	9'-6	9'-9	400	400	365	330	301	276	255	236	191	176	164	152	142	132	124	
4.50 (t=3.00) 50 psf	1.5VLR22	5'-9	6'-8	6'-10	400	373	303	271	245	222	202	185	170	156	144	133	124	115	107	
	1.5VLR20	6'-9	7'-8	7'-11	400	400	366	331	270	245	224	205	189	174	161	149	139	129	120	
	1.5VLR19	7'-5	8'-4	8'-7	400	400	393	356	325	266	243	223	205	189	175	163	151	141	132	
	1.5VLR18	7'-9	8'-11	9'-3	400	400	400	378	344	316	259	238	219	202	188	174	163	152	142	
	1.5VLR16	8'-4	9'-1	9'-4	400	400	400	377	344	315	291	237	218	202	187	174	162	151	141	
5.00 (t=3.50) 56 psf	1.5VLR22	5'-7	6'-5	6'-7	400	400	344	308	277	251	229	209	192	177	164	151	140	130	121	
	1.5VLR20	6'-6	7'-4	7'-7	400	400	400	375	306	278	254	232	214	197	182	169	157	146	136	
	1.5VLR19	7'-2	8'-0	8'-3	400	400	400	400	367	301	275	252	232	214	199	184	172	160	149	
	1.5VLR18	7'-5	8'-7	8'-10	400	400	400	400	389	321	293	269	248	229	213	198	184	172	161	
	1.5VLR16	8'-0	8'-9	9'-0	400	400	400	400	388	356	328	268	247	228	212	197	183	171	160	
5.50 (t=4.00) 62 psf	1.5VLR22	5'-5	6'-2	6'-4	400	400	385	345	310	281	256	235	216	199	183	170	157	146	136	
	1.5VLR20	6'-3	7'-1	7'-4	400	400	400	380	343	311	284	260	239	221	204	190	176	164	153	
	1.5VLR19	6'-11	7'-9	8'-0	400	400	400	400	371	337	308	282	260	240	222	207	192	179	168	
	1.5VLR18	7'-2	8'-3	8'-6	400	400	400	400	400	359	328	301	278	257	238	221	206	193	180	
	1.5VLR16	7'-8	8'-5	8'-8	400	400	400	400	400	398	327	300	276	255	237	220	205	192	179	
6.00 (t=4.50) 68 psf	1.5VLR22	5'-3	6'-0	6'-2	400	400	400	382	344	312	284	260	239	220	204	188	175	162	151	
	1.5VLR20	6'-1	6'-10	7'-1	400	400	400	400	380	345	315	289	265	245	227	210	196	182	170	
	1.5VLR19	6'-9	7'-5	7'-8	400	400	400	400	400	374	341	313	288	266	247	229	213	199	186	
	1.5VLR18	7'-0	8'-0	8'-3	400	400	400	400	400	398	364	334	308	285	264	245	229	214	200	
	1.5VLR16	7'-5	8'-1	8'-5	400	400	400	400	400	396	362	332	306	283	263	244	228	213	199	

Notes:

- Maximum unshored spans do not consider web crippling. Required bearing should be determined based on allowable reactions on page 43 or with the Vulcraft Unshored Span Calculator available at www.vulcraft.com/designtools. The following conditions are required to meet the maximum unshored spans shown:
 - Minimum exterior bearing length of 1.5" for 22 to 16 gage.
 - Minimum interior bearing length of 2" for 22 to 16 gage.
- Always contact Vulcraft when using loads in excess of 200 psf. Such loads often result from concentrated, dynamic or "long term" load cases for which reductions due to bond breakage, concrete creep etc. should be evaluated.
- All fire rated assemblies are subject to an upper live load limit of 250 psf.

1.5VLR COMPOSITE DECK

DIMENSIONS

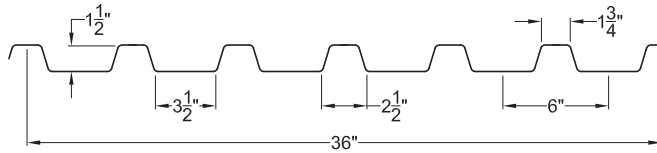

SLAB INFORMATION

Total Slab Depth (in.)	Theo. Concrete Volume (Yd ³ /100 ft ²)	(ft ³ /ft ²)	Recommended Welded Wire Fabric
3 1/2	0.92	0.247	6x6 - W1.4xW1.4
4	1.07	0.289	6x6 - W1.4xW1.4
4 1/2	1.22	0.331	6x6 - W1.4xW1.4
4 3/4	1.30	0.352	6x6 - W1.4xW1.4
5	1.38	0.372	6x6 - W2.1xW2.1
5 1/2	1.53	0.414	6x6 - W2.1xW2.1
5 3/4	1.61	0.435	6x6 - W2.1xW2.1
6	1.69	0.456	6x6 - W2.1xW2.1

*Volumes and weights do not include allowance for deflection.

(N = 14.15) LIGHT WEIGHT CONCRETE (110 PCF)

TOTAL SLAB DEPTH	DECK TYPE	SDI Max. Unshored Clear Span			Superimposed Live Load (PSF)															
		1 SPAN	2 SPAN	3 SPAN	Clear Span (ft-in.)															
					5'-0	5'-6	6'-0	6'-6	7'-0	7'-6	8'-0	8'-6	9'-0	9'-6	10'-0	10'-6	11'-0	11'-6	12'-0	
3.50 (t=2.00) 29 psf	1.5VLR22	6'-10	8'-0	8'-2	278	247	222	200	165	149	136	125	115	103	88	76	66	58	51	
	1.5VLR20	8'-1	9'-2	9'-6	305	271	243	220	201	184	170	139	128	110	95	82	71	62	55	
	1.5VLR19	8'-10	9'-11	10'-3	329	292	262	237	216	198	183	163	137	117	100	86	75	66	58	
	1.5VLR18	9'-2	10'-8	11'-0	350	311	279	252	230	211	195	171	144	123	105	91	79	69	61	
	1.5VLR16	9'-10	10'-10	11'-2	352	312	280	253	231	212	195	181	158	135	115	100	87	76	67	
4.00 (t=2.50) 34 psf	1.5VLR22	6'-7	7'-8	7'-10	324	288	258	233	192	174	159	146	134	124	115	106	98	86	76	
	1.5VLR20	7'-9	8'-9	9'-1	355	315	283	256	233	214	176	161	149	138	128	119	105	92	81	
	1.5VLR19	8'-5	9'-6	9'-10	382	339	304	275	251	230	212	175	161	149	139	128	111	97	85	
	1.5VLR18	8'-9	10'-2	10'-6	400	360	323	292	266	244	225	209	173	160	148	134	116	102	90	
	1.5VLR16	9'-5	10'-4	10'-8	400	360	323	292	266	244	225	209	195	159	148	138	128	112	98	
4.50 (t=3.00) 39 psf	1.5VLR22	6'-4	7'-4	7'-6	372	330	296	244	220	200	183	167	154	142	132	122	114	106	99	
	1.5VLR20	7'-5	8'-5	8'-8	400	361	324	293	267	221	202	185	171	158	146	136	127	118	111	
	1.5VLR19	8'-1	9'-2	9'-6	400	388	348	315	287	264	243	201	185	171	159	148	138	129	120	
	1.5VLR18	8'-5	9'-10	10'-2	400	400	369	334	305	279	258	214	198	183	170	158	148	138	126	
	1.5VLR16	9'-1	9'-11	10'-4	400	400	369	334	304	279	257	239	222	182	169	158	147	138	129	
4.75 (t=3.25) 41 psf	1.5VLR22	6'-3	7'-3	7'-4	396	352	316	260	235	213	195	179	164	152	141	131	121	113	106	
	1.5VLR20	7'-4	8'-3	8'-7	400	385	345	312	285	236	215	198	182	168	156	145	135	126	118	
	1.5VLR19	7'-11	9'-0	9'-4	400	400	371	336	306	281	233	214	197	183	170	158	147	138	129	
	1.5VLR18	8'-3	9'-7	9'-11	400	400	393	356	324	298	274	228	211	195	181	169	158	148	138	
	1.5VLR16	8'-11	9'-9	10'-1	400	400	392	355	324	297	274	254	210	194	180	168	157	147	138	
5.00 (t=3.5) 43 psf	1.5VLR22	6'-1	7'-1	7'-3	400	374	335	277	250	227	207	190	175	161	149	139	129	120	112	
	1.5VLR20	7'-2	8'-1	8'-5	400	400	367	332	302	250	229	210	194	179	166	154	144	134	126	
	1.5VLR19	7'-10	8'-10	9'-2	400	400	394	356	325	298	248	227	210	194	180	168	157	146	137	
	1.5VLR18	8'-2	9'-5	9'-9	400	400	400	378	344	316	291	242	224	207	193	179	168	157	147	
	1.5VLR16	8'-9	9'-7	9'-11	400	400	400	377	343	315	291	269	223	206	192	178	167	156	146	
5.75 (t=4.25) 50 psf	1.5VLR22	5'-10	6'-9	6'-11	400	400	364	326	295	268	244	224	206	191	177	164	153	142	133	
	1.5VLR20	6'-10	7'-9	8'-0	400	400	400	391	325	295	270	248	229	211	196	182	170	159	149	
	1.5VLR19	7'-6	8'-5	8'-8	400	400	400	400	383	351	292	268	248	229	213	198	185	173	162	
	1.5VLR18	7'-9	9'-0	9'-4	400	400	400	400	400	372	311	286	264	245	227	212	198	185	174	
	1.5VLR16	8'-4	9'-2	9'-5	400	400	400	400	400	371	342	285	263	243	226	211	197	184	173	

Notes:

1. Maximum unshored spans do not consider web crippling. Required bearing should be determined based on allowable reactions on page 43 or with the Vulcraft Unshored Span Calculator available at www.vulcraft.com/designtools. The following conditions are required to meet the maximum unshored spans shown:

- Minimum exterior bearing length of 1.5" for 22 to 16 gage.
- Minimum interior bearing length of 2" for 22 to 16 gage.

2. Always contact Vulcraft when using loads in excess of 200 psf. Such loads often result from concentrated, dynamic or "long term" load cases for which reductions due to bond breakage, concrete creep etc. should be evaluated.

3. All fire rated assemblies are subject to an upper live load limit of 250 psf.

2VLI COMPOSITE DECK

SECTION PROPERTIES

Deck Gauge	Design Thickness (in.)	Deck Weight (psf)	Section Properties				V _a (lbs/ft)	F _y (ksi)
			I _p (in ⁴ /ft)	S _p (in ³ /ft)	I _n (in ⁴ /ft)	S _n (in ³ /ft)		
22	0.0295	1.56	0.314	0.244	0.314	0.254	1641	50
20	0.0358	1.89	0.403	0.326	0.402	0.337	2419	50
19	0.0418	2.21	0.489	0.409	0.487	0.421	2863	50
18	0.0474	2.50	0.558	0.485	0.558	0.500	3240	50
16	0.0598	3.16	0.704	0.653	0.704	0.653	3255	40

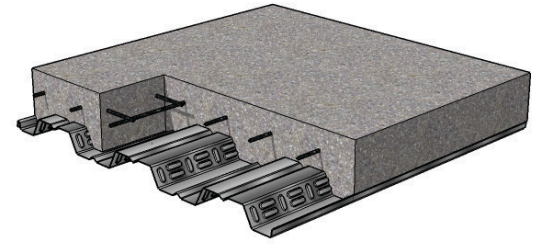

(N = 9.35) NORMAL WEIGHT CONCRETE (145 PCF)

TOTAL SLAB DEPTH	DECK TYPE	SDI Max. Unshored Clear Span		Superimposed Live Load (PSF)																
					Clear Span (ft-in.)															
		1 SPAN	2 SPAN	3 SPAN	5'-6"	6'-0"	6'-6"	7'-0"	7'-6"	8'-0"	8'-6"	9'-0"	9'-6"	10'-0"	10'-6"	11'-0"	11'-6"	12'-0"	12'-6"	
4.00 (t=2.00) 39 psf	2VLI22	7'-10"	9'-0"	9'-3"	274	239	211	188	169	129	115	104	94	85	78	71	65	59	54	
	2VLI20	9'-5"	10'-5"	10'-9"	310	269	236	210	188	170	155	142	106	96	88	80	73	67	62	
	2VLI19	10'-1"	11'-7"	12'-0"	344	298	261	231	207	186	169	155	142	131	97	88	81	74	68	
	2VLI18	10'-6"	12'-8"	12'-6"	373	324	285	253	228	206	188	172	159	147	137	103	95	87	81	
	2VLI16	11'-3"	12'-10"	13'-3"	400	376	330	292	261	235	214	195	180	166	154	143	109	100	93	
4.50 (t=2.50) 45 psf	2VLI22	7'-6"	8'-7"	8'-10"	319	278	245	218	196	150	134	121	109	99	90	83	76	69	63	
	2VLI20	9'-0"	9'-11"	10'-3"	361	313	275	244	219	198	180	165	123	112	102	93	85	78	72	
	2VLI19	9'-8"	11'-1"	11'-5"	400	346	303	268	240	216	196	180	165	124	113	103	94	86	79	
	2VLI18	10'-1"	12'-1"	12'-1"	400	376	331	295	264	239	218	200	184	171	130	120	110	102	94	
	2VLI16	10'-10"	12'-3"	12'-8"	400	400	383	339	303	274	248	227	209	193	179	137	126	117	108	
5.00 (t=3.00) 51 psf	2VLI22	7'-2"	8'-3"	8'-5"	364	317	279	249	192	171	153	138	125	113	103	94	86	79	72	
	2VLI20	8'-7"	9'-6"	9'-10"	400	356	313	278	249	225	205	156	141	128	116	106	97	89	82	
	2VLI19	9'-3"	10'-7"	10'-11"	400	394	345	306	273	247	224	205	156	141	129	117	107	99	91	
	2VLI18	9'-8"	11'-6"	11'-9"	400	400	377	336	301	273	249	228	210	162	148	136	126	116	107	
	2VLI16	10'-5"	11'-9"	12'-2"	400	400	400	386	346	312	283	259	238	220	171	157	144	133	123	
5.50 (t=3.50) 57 psf	2VLI22	6'-10"	7'-11"	8'-1"	400	355	313	244	216	192	172	155	140	127	116	106	97	89	81	
	2VLI20	8'-3"	9'-1"	9'-5"	400	400	351	312	280	253	194	175	158	143	131	119	109	100	92	
	2VLI19	8'-11"	10'-2"	10'-6"	400	400	388	343	307	277	251	194	175	159	144	132	121	111	102	
	2VLI18	9'-4"	11'-1"	11'-5"	400	400	400	377	338	306	279	256	199	182	167	153	141	130	121	
	2VLI16	10'-0"	11'-3"	11'-8"	400	400	400	400	388	350	318	290	267	246	192	176	162	150	138	
6.00 (t=4.00) 63 psf	2VLI22	6'-7"	7'-7"	7'-10"	400	394	348	270	239	213	191	172	156	141	129	118	108	99	90	
	2VLI20	7'-11"	8'-9"	9'-1"	400	400	390	346	310	241	215	194	175	159	145	132	121	111	102	
	2VLI19	8'-8"	9'-10"	10'-2"	400	400	400	381	340	307	279	215	194	176	160	146	134	123	113	
	2VLI18	9'-0"	10'-8"	11'-0"	400	400	400	400	375	339	309	284	221	202	185	170	157	145	134	
	2VLI16	9'-9"	10'-10"	11'-3"	400	400	400	400	400	388	352	322	296	233	213	195	180	166	154	
6.50 (t=4.50) 69 psf	2VLI22	6'-5"	7'-4"	7'-6"	400	400	339	297	263	234	210	189	171	155	141	129	118	108	99	
	2VLI20	7'-8"	8'-6"	8'-9"	400	400	400	380	341	265	237	213	193	175	159	145	133	122	112	
	2VLI19	8'-5"	9'-6"	9'-9"	400	400	400	400	374	337	262	236	213	193	176	161	147	135	124	
	2VLI18	8'-9"	10'-4"	10'-8"	400	400	400	400	400	373	340	268	243	222	203	187	172	159	147	
	2VLI16	9'-5"	10'-6"	10'-10"	400	400	400	400	400	400	387	353	281	256	234	215	198	183	169	

Notes:

- Maximum unshored spans do not consider web crippling. Required bearing should be determined based on allowable reactions on page 43 or with the Vulcraft Unshored Span Calculator available at www.vulcraft.com/designtools. The following conditions are required to meet the maximum unshored spans shown:
 - Minimum exterior bearing length of 1.5" for 20 to 16 gage. Minimum end bearing varies from 1.5" to 1.75" for 22 gage, depending on slab thickness.
 - Minimum interior bearing length of 2" for 19 to 16 gage. Minimum interior bearing varies from 2.125" to 5.125" for 20 and 22 gage, depending on gage and slab thickness.
- Always contact Vulcraft when using loads in excess of 200 psf. Such loads often result from concentrated, dynamic or "long term" load cases for which reductions due to bond breakage, concrete creep etc. should be evaluated.
- All fire rated assemblies are subject to an upper live load limit of 250 psf.

2VLI COMPOSITE DECK

DIMENSIONS

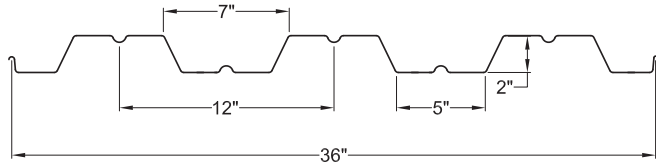

SLAB INFORMATION

Total Slab Depth (in.)	Theo. Concrete Volume (Yd ³ /100 ft ²)	(ft ³ /ft ²)	Recommended Welded Wire Fabric
4	0.93	0.250	6x6 - W1.4xW1.4
4 1/2	1.08	0.292	6x6 - W1.4xW1.4
5	1.23	0.333	6x6 - W1.4xW1.4
5 1/4	1.31	0.354	6x6 - W1.4xW1.4
5 1/2	1.39	0.375	6x6 - W2.1xW2.1
6	1.54	0.417	6x6 - W2.1xW2.1
6 1/4	1.62	0.438	6x6 - W2.1xW2.1
6 1/2	1.70	0.458	6x6 - W2.1xW2.1

*Volumes and weights do not include allowance for deflection.

(N = 14.15) LIGHT WEIGHT CONCRETE (110 PCF)

TOTAL SLAB DEPTH	DECK TYPE	SDI Max. Unshored Clear Span			Superimposed Live Load (PSF)														
		1 SPAN	2 SPAN	3 SPAN	Clear Span (ft-in.)														
					6'-0	6'-6	7'-0	7'-6	8'-0	8'-6	9'-0	9'-6	10'-0	10'-6	11'-0	11'-6	12'-0	12'-6	13'-0
4.00 (t=2.00) 30 psf	2VLI22	8'-7	9'-10	10'-2	238	209	186	167	152	138	108	98	90	82	75	69	64	59	55
	2VLI20	10'-4	11'-4	11'-9	268	235	209	187	169	153	140	129	119	92	84	78	72	66	61
	2VLI19	11'-0	12'-8	13'-0	297	260	230	206	185	168	153	141	130	121	112	86	79	73	68
	2VLI18	11'-5	13'-9	13'-5	324	285	253	227	205	187	171	158	146	136	127	99	92	86	80
	2VLI16	12'-1	14'-0	14'-2	377	330	292	261	235	214	195	179	165	153	143	133	118	98	91
4.50 (t=2.50) 35 psf	2VLI22	8'-2	9'-5	9'-9	276	243	216	194	176	139	126	114	104	96	88	81	75	69	64
	2VLI20	9'-11	10'-11	11'-3	312	273	243	217	196	178	163	150	117	107	98	91	84	77	72
	2VLI19	10'-7	12'-2	12'-7	346	302	268	239	215	195	178	164	151	140	108	100	92	85	79
	2VLI18	11'-0	13'-2	12'-11	376	331	294	264	238	217	199	183	170	158	147	116	107	100	93
	2VLI16	11'-8	13'-5	13'-8	400	384	340	303	273	248	227	208	192	178	166	155	123	114	106
5.00 (t=3.00) 39 psf	2VLI22	7'-10	9'-1	9'-4	315	277	247	222	176	159	144	130	119	109	100	92	85	79	73
	2VLI20	9'-6	10'-5	10'-10	355	312	276	248	224	203	186	171	134	122	112	103	95	88	82
	2VLI19	10'-2	11'-8	12'-1	394	345	305	272	245	223	203	187	172	135	124	114	105	97	90
	2VLI18	10'-7	12'-8	12'-7	400	377	335	300	272	247	227	209	193	180	143	132	123	114	106
	2VLI16	11'-4	12'-11	13'-3	400	400	387	346	311	283	258	237	219	203	189	151	140	130	121
5.25 (t=3.25) 41 psf	2VLI22	7'-9	8'-11	9'-1	334	294	262	235	187	168	152	138	126	116	106	98	90	84	78
	2VLI20	9'-3	10'-3	10'-7	377	331	293	263	237	216	197	156	142	130	119	110	101	94	87
	2VLI19	9'-11	11'-5	11'-10	400	366	324	289	260	236	216	198	156	143	131	121	111	103	96
	2VLI18	10'-5	12'-5	12'-5	400	400	355	319	288	263	241	222	205	164	152	140	130	121	113
	2VLI16	11'-2	12'-8	13'-1	400	400	400	367	330	300	274	252	232	215	201	160	149	138	129
5.50 (t=3.5) 44 psf	2VLI22	7'-7	8'-9	8'-11	353	311	277	249	198	178	161	147	134	123	113	104	96	89	82
	2VLI20	9'-1	10'-1	10'-5	399	350	310	278	251	228	209	165	150	137	126	116	107	99	92
	2VLI19	9'-9	11'-3	11'-7	400	387	342	306	275	250	228	209	165	151	139	128	118	109	101
	2VLI18	10'-2	12'-3	12'-3	400	400	376	337	305	278	254	234	217	174	160	148	138	128	119
	2VLI16	11'-0	12'-5	12'-10	400	400	400	388	350	317	290	266	246	228	212	170	157	146	136
6.25 (t=4.25) 51 psf	2VLI22	7'-2	8'-3	8'-6	400	362	322	258	231	208	188	171	156	143	131	121	112	103	96
	2VLI20	8'-8	9'-7	9'-11	400	400	361	323	292	266	211	192	175	160	147	135	125	116	107
	2VLI19	9'-4	10'-8	11'-0	400	400	398	356	320	291	265	212	193	176	162	149	137	127	118
	2VLI18	9'-9	11'-7	11'-10	400	400	400	392	355	323	296	273	220	202	187	173	160	149	139
	2VLI16	10'-6	11'-10	12'-3	400	400	400	400	400	369	337	310	286	265	214	198	183	170	159

Notes:

- Maximum unshored spans do not consider web crippling. Required bearing should be determined based on allowable reactions on page 43 or with the Vulcraft Unshored Span Calculator available at www.vulcraft.com/designtools. The following conditions are required to meet the maximum unshored spans shown:
 - Minimum exterior bearing length of 1.5" for 22 to 16 gage.
 - Minimum interior bearing length of 2" for 20 to 16 gage. Minimum interior bearing varies from 2.125" to 3.625" for 22 gage, depending on slab thickness.
- Always contact Vulcraft when using loads in excess of 200 psf. Such loads often result from concentrated, dynamic or "long term" load cases for which reductions due to bond breakage, concrete creep etc. should be evaluated.
- All fire rated assemblies are subject to an upper live load limit of 250 psf.

3VLI COMPOSITE DECK

SECTION PROPERTIES

Deck Gauge	Design Thickness (in.)	Deck Weight (psf)	Section Properties				V _a (lbs/ft)	F _y (ksi)
			I _p (in ⁴ /ft)	S _p (in ³ /ft)	I _n (in ⁴ /ft)	S _n (in ³ /ft)		
22	0.0295	1.71	0.710	0.387	0.715	0.410	1407	50
20	0.0358	2.07	0.907	0.512	0.909	0.538	2485	50
19	0.0418	2.42	1.098	0.639	1.100	0.668	3390	50
18	0.0474	2.75	1.252	0.761	1.252	0.794	4361	50
16	0.0598	3.47	1.582	1.013	1.582	1.013	4901	40

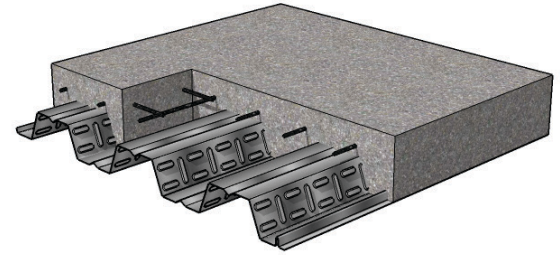

(N = 9.35) NORMAL WEIGHT CONCRETE (145 PCF)

TOTAL SLAB DEPTH	DECK TYPE	SDI Max. Unshored Clear Span			Superimposed Live Load (PSF)															
		1 SPAN	2 SPAN	3 SPAN	Clear Span (ft-in.)															
					7'-0"	7'-6"	8'-0"	8'-6"	9'-0"	9'-6"	10'-0"	10'-6"	11'-0"	11'-6"	12'-0"	12'-6"	13'-0"	13'-6"	14'-0"	
5.00 (t=2.00) 45 psf	3VLI22	10'-0"	10'-9"	11'-1"	216	195	176	161	148	137	127	90	83	76	70	64	59	54	50	
	3VLI20	11'-8"	12'-5"	12'-10"	241	216	196	178	163	150	139	129	121	113	78	72	66	61	57	
	3VLI19	12'-3"	13'-11"	14'-4"	265	237	214	194	178	163	151	140	131	122	115	79	73	68	62	
	3VLI18	12'-7"	15'-2"	14'-9"	289	261	238	218	201	186	173	161	151	142	134	127	92	86	80	
	3VLI16	13'-4"	15'-3"	15'-7"	327	294	267	243	223	206	191	178	167	156	147	139	132	96	89	
5.50 (t=2.50) 51 psf	3VLI22	9'-6"	9'-11"	10'-7"	247	222	201	184	169	156	113	103	94	87	80	73	67	62	57	
	3VLI20	11'-3"	11'-11"	12'-4"	275	247	223	203	186	171	159	148	138	97	89	82	76	70	65	
	3VLI19	11'-10"	13'-4"	13'-9"	302	270	244	222	203	186	172	160	149	139	98	91	84	77	71	
	3VLI18	12'-3"	14'-6"	14'-4"	330	298	271	248	229	212	197	184	173	162	153	112	105	98	92	
	3VLI16	12'-11"	14'-7"	15'-1"	373	335	304	277	255	235	218	203	190	178	168	159	117	109	102	
6.00 (t=3.00) 57 psf	3VLI22	9'-2"	9'-2"	10'-2"	277	249	226	206	190	140	127	116	106	97	89	82	76	70	65	
	3VLI20	10'-9"	11'-5"	11'-10"	309	277	250	228	209	193	178	166	119	109	100	92	85	79	73	
	3VLI19	11'-7"	12'-9"	13'-2"	339	304	274	249	227	209	193	179	167	156	111	102	94	87	80	
	3VLI18	11'-11"	13'-11"	14'-0"	370	334	304	279	257	238	221	207	194	182	136	126	118	110	103	
	3VLI16	12'-7"	14'-0"	14'-6"	400	376	341	311	286	264	245	228	213	200	189	178	132	123	115	
6.50 (t=3.50) 63 psf	3VLI22	8'-9"	8'-6"	9'-8"	307	277	251	229	171	155	141	129	118	108	99	91	84	78	72	
	3VLI20	10'-4"	11'-0"	11'-4"	343	307	278	253	232	214	198	144	132	121	111	103	95	87	81	
	3VLI19	11'-3"	12'-4"	12'-9"	377	337	304	276	252	232	214	199	185	134	123	113	104	96	89	
	3VLI18	11'-8"	13'-5"	13'-8"	400	371	338	309	285	264	246	229	215	202	151	140	131	123	115	
	3VLI16	12'-4"	13'-6"	14'-0"	400	400	378	345	317	293	272	253	237	222	209	157	146	137	128	
7.00 (t=4.00) 69 psf	3VLI22	8'-6"	7'-11"	9'-0"	338	304	276	252	188	171	155	142	130	119	109	101	93	86	79	
	3VLI20	10'-0"	10'-8"	11'-0"	377	338	305	278	255	235	217	159	145	133	122	113	104	96	89	
	3VLI19	11'-0"	11'-11"	12'-3"	400	370	334	303	277	255	236	219	204	147	135	124	115	106	98	
	3VLI18	11'-5"	13'-0"	13'-4"	400	400	371	340	313	290	270	252	236	178	166	154	144	135	126	
	3VLI16	12'-1"	13'-1"	13'-6"	400	400	400	379	348	322	298	278	260	244	230	172	161	150	141	
7.50 (t=4.50) 75 psf	3VLI22	8'-2"	7'-5"	8'-6"	368	331	300	228	205	186	169	154	141	130	119	110	101	93	86	
	3VLI20	9'-8"	10'-3"	10'-7"	400	368	333	303	278	256	190	173	158	145	134	123	114	105	97	
	3VLI19	10'-8"	11'-6"	11'-11"	400	400	364	331	302	278	257	238	175	160	147	136	125	116	107	
	3VLI18	11'-2"	12'-7"	13'-0"	400	400	400	370	341	316	294	275	258	195	181	168	157	147	138	
	3VLI16	11'-10"	12'-8"	13'-1"	400	400	400	400	380	351	325	303	283	266	202	188	175	164	153	

- Notes:**
- Maximum unshored spans do not consider web crippling. Required bearing should be determined based on allowable reactions on page 43 or with the Vulcraft Unshored Span Calculator available at www.vulcraft.com/designtools. The following conditions are required to meet the maximum unshored spans shown:
 - Minimum exterior bearing length of 1.5" for 19 to 16 gage. Minimum end bearing varies from 1.5" to 3.5" for 22 and 20 gage, depending on slab thickness.
 - Minimum interior bearing length of 2" for 16 gage. Minimum interior bearing varies from 2" to 6.25" for 18 to 22 gage, depending on gage and slab thickness.
 - Always contact Vulcraft when using loads in excess of 200 psf. Such loads often result from concentrated, dynamic or "long term" load cases for which reductions due to bond breakage, concrete creep etc. should be evaluated.
 - All fire rated assemblies are subject to an upper live load limit of 250 psf.

3VLI COMPOSITE DECK

DIMENSIONS

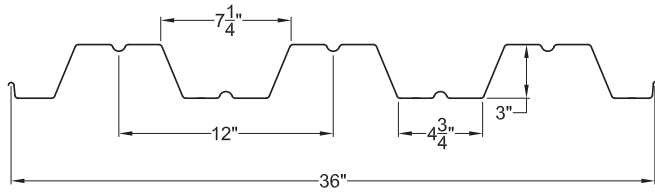

SLAB INFORMATION

Total Slab Depth (in.)	Theo. Concrete Volume (Yd ³ /100 ft ²)	(ft ³ /ft ²)	Recommended Welded Wire Fabric
5	1.08	0.292	6x6 - W1.4xW1.4
5 1/2	1.23	0.333	6x6 - W1.4xW1.4
6	1.39	0.375	6x6 - W1.4xW1.4
6 1/4	1.47	0.396	6x6 - W1.4xW1.4
6 1/2	1.54	0.417	6x6 - W2.1xW2.1
7	1.70	0.458	6x6 - W2.1xW2.1
7 1/4	1.77	0.479	6x6 - W2.1xW2.1
7 1/2	1.85	0.500	6x6 - W2.1xW2.1

*Volumes and weights do not include allowance for deflection.

(N = 14.15) LIGHT WEIGHT CONCRETE (110 PCF)

TOTAL SLAB DEPTH	DECK TYPE	SDI Max. Unshored Clear Span			Superimposed Live Load (PSF)															
		1 SPAN	2 SPAN	3 SPAN	Clear Span (ft-in.)															
					8'-0	8'-6	9'-0	9'-6	10'-0	10'-6	11'-0	11'-6	12'-0	12'-6	13'-0	13'-6	14'-0	14'-6	15'-0	
5.00 (t=2.00) 35 psf	3VLI22	11'-0	11'-10	12'-2	141	127	115	105	96	88	82	54	49	45	40					
	3VLI20	12'-6	13'-8	14'-1	163	147	133	121	110	102	94	87	81	75	49	44	40			
	3VLI19	13'-1	15'-3	15'-4	185	166	150	136	124	114	105	97	90	84	79	52	47	43		
	3VLI18	13'-6	16'-7	15'-10	244	222	204	188	174	162	151	142	133	126	119	112	85	79	75	
	3VLI16	14'-3	16'-8	16'-8	279	253	231	213	196	182	170	159	149	140	132	125	118	90	84	
5.50 (t=2.50) 39 psf	3VLI22	10'-7	11'-4	11'-8	161	145	131	120	110	101	69	62	56	51	46	42				
	3VLI20	12'-2	13'-1	13'-7	186	167	151	138	126	116	107	99	92	61	56	51	46	42		
	3VLI19	12'-8	14'-8	14'-11	211	189	171	155	142	130	120	111	103	96	65	59	54	49	45	
	3VLI18	13'-1	15'-11	15'-4	278	253	232	214	198	184	172	161	152	143	135	103	97	91	85	
	3VLI16	13'-10	16'-0	16'-2	318	289	264	242	224	208	193	181	170	160	151	142	109	103	96	
6.00 (t=3.00) 44 psf	3VLI22	10'-2	10'-11	11'-3	181	163	147	134	123	86	78	70	63	57	52	47	43			
	3VLI20	11'-10	12'-8	13'-1	209	188	170	155	141	130	120	111	76	69	63	57	52	47	43	
	3VLI19	12'-4	14'-1	14'-6	237	212	192	174	159	146	135	125	116	80	73	67	61	56	51	
	3VLI18	12'-9	15'-4	14'-11	312	284	261	240	223	207	193	181	170	161	124	116	109	102	96	
	3VLI16	13'-6	15'-6	15'-9	357	324	296	272	251	233	217	203	190	179	169	160	123	115	108	108
6.25 (t=3.25) 46 psf	3VLI22	9'-11	10'-8	11'-1	191	172	155	142	101	91	82	74	67	60	55	50	45	41		
	3VLI20	11'-8	12'-5	12'-10	221	198	179	163	149	137	127	117	80	73	66	60	55	50	46	
	3VLI19	12'-3	13'-10	14'-4	250	224	202	184	168	154	142	131	122	84	77	70	64	59	54	
	3VLI18	12'-7	15'-1	14'-9	329	300	275	253	235	218	204	191	180	169	131	122	115	108	101	
	3VLI16	13'-4	15'-2	15'-7	377	342	312	287	265	246	229	214	201	189	178	139	130	122	114	
6.50 (t=3.5) 48 psf	3VLI22	9'-9	10'-5	10'-10	200	180	164	149	107	96	86	78	70	64	58	52	47	43		
	3VLI20	11'-6	12'-3	12'-7	232	209	189	172	157	144	133	123	84	77	70	63	58	53	48	
	3VLI19	12'-1	13'-8	14'-1	263	236	213	193	176	162	149	138	128	89	81	74	68	62	57	
	3VLI18	12'-5	14'-10	14'-7	346	316	289	267	247	230	215	201	189	147	138	129	121	113	107	
	3VLI16	13'-2	14'-11	15'-5	396	360	329	302	279	259	241	225	211	199	188	146	137	128	121	
7.25 (t=4.25) 55 psf	3VLI22	9'-4	9'-6	10'-4	230	207	188	137	122	110	99	89	81	73	66	60	55	49	45	
	3VLI20	11'-0	11'-8	12'-0	267	240	217	197	180	166	153	107	97	88	80	73	67	61	55	
	3VLI19	11'-8	13'-0	13'-5	302	271	244	222	203	186	171	159	112	102	93	85	78	71	65	
	3VLI18	12'-1	14'-2	14'-2	398	362	332	306	284	264	246	231	217	170	158	148	139	130	123	
	3VLI16	12'-9	14'-3	14'-9	400	400	377	347	320	297	277	259	243	228	180	168	157	148	139	

Notes:

1. Maximum unshored spans do not consider web crippling. Required bearing should be determined based on allowable reactions on page 43 or with the Vulcraft Unshored Span Calculator available at www.vulcraft.com/designtools. The following conditions are required to meet the maximum unshored spans shown:

- Minimum exterior bearing length of 1.5" for 20 to 16 gage. Minimum end bearing varies from 1.5" to 2.5" for 22 gage, depending on slab thickness.
- Minimum interior bearing length of 2" for 18 and 16 gage. Minimum end bearing varies from 2" to 6.25" for 22 to 19 gage, depending on gage and slab thickness.

2. Always contact Vulcraft when using loads in excess of 200 psf. Such loads often result from concentrated, dynamic or "long term" load cases for which reductions due to bond breakage, concrete creep etc. should be evaluated.

3. All fire rated assemblies are subject to an upper live load limit of 250 psf.



COMPOSITE DECK FIRE RESISTANCE RATINGS

Restrained Assembly Rating	Type of Protection	Concrete Thickness & Type (1)	U.L. Design No. (2,3,4)	Classified Deck Type		Unrestrained Beam Rating
				Fluted Deck	Cellular Deck (5)	
3/4 Hr.	Unprotected Deck	2 1/2" LW	D914 #	1.5VL,1.5VLI,2VLI,3VLI	1.5VLP, 2VLP, 3VLP	1 Hr.
			D916 #	1.5VL,1.5VLI,2VLI,3VLI	1.5VLP, 2VLP, 3VLP	1,1.5,2,3 Hr.
1 Hr.	Exposed Grid	2 1/2" NW	D216 +	1.5VL,1.5VLI,2VLI,3VLI	2VLP, 3VLP	2,3 Hr.
	Cementitious	2" NW&LW	D743 *	2VLI,3VLI	2VLP, 3VLP	1,1.5,2,3 Hr.
			D703 *	1.5VLI,2VLI,3VLI	1.5VLP, 2VLP, 3VLP	1.5 Hr.
		2 1/2" NW&LW	D712 *	3VLI	3VLP	2 Hr.
			D722 *	2VLI,3VLI	2VLP, 3VLP	1,1.5,2 Hr.
			D739 *	1.5VLI,2VLI,3VLI	1.5VLP, 2VLP, 3VLP	1,1.5,2,3,4 Hr.
			D759	1.5VL,1.5VLI,2VLI,3VLI	1.5VLP, 2VLP, 3VLP	1,1.5,2,3 Hr.
	Sprayed Fiber	2" NW&LW	D859 *	2VLI,3VLI	2VLP, 3VLP	1,1.5,2,3 Hr.
			D832 *	1.5VLI,2VLI,3VLI	1.5VLP, 2VLP, 3VLP	1,1.5,2,3 Hr.
		2 1/2" NW&LW	D847 *	2VLI,3VLI	3VLP	1,1.5,3 Hr.
			D858 *	2VLI,3VLI	2VLP, 3VLP	1,1.5,2,4 Hr.
	Unprotected Deck	2 1/2" LW	D871 *	2VLI,3VLI	2VLP, 3VLP	1,1.5,2,3 Hr.
			D902 #	1.5VL,1.5VLI,2VLI,3VLI	1.5VLP, 2VLP, 3VLP	1,1.5 Hr.
			D914 #	1.5VL,1.5VLI,2VLI,3VLI	1.5VLP, 2VLP, 3VLP	1 Hr.
			D916 #	1.5VL,1.5VLI,2VLI,3VLI	1.5VLP, 2VLP, 3VLP	1,1.5,2,3 Hr.
			D918 #	1.5VL,1.5VLI,2VLI,3VLI	1.5VLP, 2VLP, 3VLP	1,1.5 Hr.
		3 1/2" NW	D919 #	1.5VL,1.5VLI,2VLI,3VLI	1.5VLP, 2VLP, 3VLP	1,1.5 Hr.
			D902 #	1.5VL,1.5VLI,2VLI,3VLI	1.5VLP, 2VLP, 3VLP	1,1.5 Hr.
			D916 #	1.5VL,1.5VLI,2VLI,3VLI	1.5VLP, 2VLP, 3VLP	1,1.5,2,3 Hr.
			D918 #	1.5VL,1.5VLI,2VLI,3VLI	1.5VLP, 2VLP, 3VLP	1,1.5 Hr.
D919 #			1.5VL,1.5VLI,2VLI,3VLI	1.5VLP, 2VLP, 3VLP	1,1.5 Hr.	
11/2 Hr.	Gypsum Board	2 1/2" NW	D502 *	1.5VL,1.5VLI,2VLI,3VLI	2VLP, 3VLP	1.5,2 Hr.
	Cementitious	2" NW&LW	D743 *	2VLI,3VLI	2VLP, 3VLP	1,1.5,2,3 Hr.
			D703 *	1.5VLI,2VLI,3VLI	1.5VLP, 2VLP, 3VLP	1.5 Hr.
		2 1/2" NW&LW	D712 *	3VLI	3VLP	2 Hr.
			D722 *	2VLI,3VLI	2VLP, 3VLP	1,1.5,2 Hr.
			D739 *	1.5VLI,2VLI,3VLI	1.5VLP, 2VLP, 3VLP	1,1.5,2,3,4 Hr.
			D759	1.5VL,1.5VLI,2VLI,3VLI	1.5VLP, 2VLP, 3VLP	1,1.5,2,3 Hr.
	Sprayed Fiber	2" NW&LW	D859 *	2VLI,3VLI	2VLP, 3VLP	1,1.5,2,3 Hr.
			D832 *	1.5VLI,2VLI,3VLI	3VLP	1,1.5,2,3 Hr.
		2 1/2" NW&LW	D847 *	2VLI,3VLI	3VLP	1,1.5,3 Hr.
			D858 *	2VLI,3VLI	2VLP, 3VLP	1,1.5,2,4 Hr.
	Unprotected Deck	3" LW	D871 *	2VLI,3VLI	2VLP, 3VLP	1,1.5,2,3 Hr.
			D902 #	1.5VL,1.5VLI,2VLI,3VLI	1.5VLP, 2VLP, 3VLP	1,1.5 Hr.
			D916 #	1.5VL,1.5VLI,2VLI,3VLI	1.5VLP, 2VLP, 3VLP	1,1.5,2,3 Hr.
			D919 #	1.5VL,1.5VLI,2VLI,3VLI	1.5VLP, 2VLP, 3VLP	1,1.5 Hr.
		4" NW	D902 #	1.5VL,1.5VLI,2VLI,3VLI	1.5VLP, 2VLP, 3VLP	1,1.5 Hr.
			D916 #	1.5VL,1.5VLI,2VLI,3VLI	1.5VLP, 2VLP, 3VLP	1,1.5,2,3 Hr.
			D918 #	1.5VL,1.5VLI,2VLI,3VLI	1.5VLP, 2VLP, 3VLP	1,1.5 Hr.
			D919 #	1.5VL,1.5VLI,2VLI,3VLI	1.5VLP, 2VLP, 3VLP	1,1.5 Hr.

Notes:

- Concrete thickness is thickness of slab above deck, in.
 - Refer to the U.L. "Fire Resistance Directory" for the necessary construction details.
 - Cellular deck finish shall be galvanized.
 - Fluted deck finish shall be galvanized unless noted otherwise.
- + Denotes fluted deck finish is not critical when used in D2-- & D5-- Series designs. Deck finish shall be galvanized or phosphatized/painted.
 - * Fluted deck finish is critical for fire resistance. Fluted deck finish shall be galvanized or phosphatized/painted. This paint is a special type of paint and is compatible with the spray-applied fire protection and is U.L. approved for use in the denoted D7-- & D8-- Series designs.
 - # Denotes fluted deck finish is not critical for fire resistance. Fluted deck finish shall be galvanized or phosphatized/painted.
- Vulcraft cellular deck units are approved by U.L. for use as electrical raceways under U.L. Standard 209.

COMPOSITE

COMPOSITE DECK FIRE RESISTANCE RATINGS

Restrained Assembly Rating	Type of Protection	Concrete Thickness & Type (1)	U.L. Design No. (2,3,4)	Classified Deck Type		Unrestrained Beam Rating		
				Fluted Deck	Cellular Deck (5)			
2 Hr.	Exposed Grid	2 1/2" NW	D216 +	1.5VL,1.5VLI,2VLI,3VLI	2VLP, 3VLP	2,3 Hr.		
	Gypsum Board	2 1/2" NW	D502 +	1.5VL,1.5VLI,2VLI,3VLI	2VLP, 3VLP	1.5,2 Hr.		
	Cementitious	2" NW&LW	D743 *	2VLI,3VLI	2VLP, 3VLP	1,1.5,2,3 Hr.		
			D746 *	1.5VLI		1,1.5,2,3 Hr.		
		2 1/2" LW	D752 *	1.5VLI,2VLI,3VLI	1.5VLP, 2VLP, 3VLP	1,1.5,2, Hr.		
			D703 *	1.5VLI,2VLI,3VLI	1.5VLP, 2VLP, 3VLP	1.5 Hr.		
			D712 *	3VLI	3VLP	2 Hr.		
			D716 *	1.5VLI,2VLI,3VLI	2VLP, 3VLP	1.5,2 Hr.		
			D722 *	2VLI,3VLI	2VLP, 3VLP	1,1.5,2 Hr.		
			D739 *	1.5VLI,2VLI,3VLI	1.5VLP, 2VLP, 3VLP	1,1.5,2,3,4 Hr.		
			D745 *	2VLI,3VLI		1,1.5,2, Hr.		
			D750 *	1.5VLI,2VLI,3VLI		1.5,2 Hr.		
			D755	1.5VLI,2VLI,3VLI	1.5VLP, 2VLP, 3VLP	1,1.5,2,3 Hr.		
			D759	1.5VL,1.5VLI,2VLI,3VLI	1.5VLP, 2VLP, 3VLP	1,1.5,2,3 Hr.		
		2 1/2" NW	D760 *	2VLI,3VLI		1,1.5,2,3,4 Hr.		
			D730 *	2VLI,3VLI	2VLP, 3VLP	1.5,2 Hr.		
		Sprayed Fiber	2" NW&LW	D742 *	1.5VLI,2VLI,3VLI		1,1.5 Hr.	
				D859 *	2VLI,3VLI	2VLP, 3VLP	1,1.5,2,3 Hr.	
				2 1/2" NW&LW	D822 *	2VLI,3VLI	2VLP, 3VLP	1 Hr.
					D825 *	1.5VLI,2VLI,3VLI	2VLP, 3VLP	1,1.5,2 Hr.
					D831 *	2VLI,3VLI	2VLP, 3VLP	1,1.5,2 Hr.
					D832 *	1.5VLI,2VLI,3VLI	1.5VLP, 2VLP, 3VLP	1,1.5,2,3 Hr.
	D833 *				1.5VLI,2VLI,3VLI	2VLP, 3VLP	1.5 Hr.	
	D847 *				2VLI,3VLI	3VLP	1,1.5,3 Hr.	
	D858 *		2VLI,3VLI	2VLP, 3VLP	1,1.5,2,4 Hr.			
	D861 *		12VLI,3VLI		1,1.5 Hr.			
	D871 *	2VLI,3VLI	2VLP, 3VLP	1,1.5,2,3 Hr.				
	2 1/2" LW	D862 *	2VLI,3VLI		1 Hr.			
	2 1/2" NW	D864 *	3VLI	3VLP	1.5 Hr.			
	3 1/4" LW	D860 *	2VLI,3VLI		1,1.5,2 Hr.			
	3 1/4" LW	3 1/4" LW	D826 #	1.5VL,1.5VLI,2VLI,3VLI	1.5VLP, 2VLP, 3VLP	1,1.5,2 Hr.		
			D840 #	1.5VL,1.5VLI,2VLI,3VLI	1.5VLP, 2VLP, 3VLP	1,1.5 Hr.		
			D902 #	1.5VL,1.5VLI,2VLI,3VLI	1.5VLP, 2VLP, 3VLP	1,1.5 Hr.		
			D907 #	1.5VL,1.5VLI,2VLI,3VLI	1.5VLP, 2VLP, 3VLP	1,2 Hr.		
			D913 #	1.5VL,1.5VLI,2VLI,3VLI	1.5VLP, 2VLP, 3VLP	1 Hr.		
			D916 #	1.5VL,1.5VLI,2VLI,3VLI	1.5VLP, 2VLP, 3VLP	1,1.5,2,3 Hr.		
			D918 #	1.5VL,1.5VLI,2VLI,3VLI	1.5VLP, 2VLP, 3VLP	1,1.5 Hr.		
			D919 #	1.5VL,1.5VLI,2VLI,3VLI	1.5VLP, 2VLP, 3VLP	1,1.5 Hr.		
		D920 #	2VLI,3VLI	2VLP, 3VLP	1.5 Hr.			
		4 1/2" NW	D902 #	1.5VL,1.5VLI,2VLI,3VLI	1.5VLP, 2VLP, 3VLP	1,1.5 Hr.		
D916 #			1.5VL,1.5VLI,2VLI,3VLI	1.5VLP, 2VLP, 3VLP	1,1.5,2,3 Hr.			
D918 #			1.5VL,1.5VLI,2VLI,3VLI	1.5VLP, 2VLP, 3VLP	1,1.5 Hr.			
D919 #	1.5VL,1.5VLI,2VLI,3VLI		1.5VLP, 2VLP, 3VLP	1,1.5 Hr.				

See Page 54 for notes.

COMPOSITE

COMPOSITE DECK FIRE RESISTANCE RATINGS

Restrained Assembly Rating	Type of Protection	Concrete Thickness & Type (1)	U.L. Design No. (2,3,4)	Classified Deck Type		Unrestrained Beam Rating
				Fluted Deck	Cellular Deck (5)	
3 Hr.	Exposed Grid	3 1/4" NW	D216 +	1.5VL,1.5VLI,2VLI,3VLI	2VLP, 3VLP	2,3 Hr.
	Cementitious	2" NW&LW	D743 *	2VLI,3VLI	2VLP, 3VLP	1,1.5,2,3 Hr.
		2 1/2" LW	D746 *	1.5VLI		1,1.5,2,3 Hr.
		2 1/2" NW&LW	D703 *	1.5VLI,2VLI,3VLI	1.5VLP, 2VLP, 3VLP	1.5 Hr.
			D708 *	1.5VLI,2VLI,3VLI	1.5VLP, 2VLP, 3VLP	1.5,3 Hr.
			D739 *	1.5VLI,2VLI,3VLI	1.5VLP, 2VLP, 3VLP	1,1.5,2,3,4 Hr.
			D755	1.5VLI,2VLI,3VLI	1.5VLP, 2VLP, 3VLP	1,1.5,2,3 Hr.
			D759	1.5VL,1.5VLI,2VLI,3VLI	1.5VLP, 2VLP, 3VLP	1,1.5,2,3 Hr.
			D760 *	2VLI,3VLI		1,1.5,2,3,4 Hr.
		3 1/4" LW	D754 *	1.5VLI,2VLI,3VLI		1.5,2 Hr.
		3 1/4" NW	D742 *	1.5VLI,2VLI,3VLI		1,1.5 Hr.
	Sprayed Fiber	2" NW&LW	D859 *	2VLI,3VLI	2VLP, 3VLP	1,1.5,2,3 Hr.
		2 1/2" NW&LW	D816 *	1.5VLI,2VLI,3VLI	2VLP, 3VLP	1.5,2 Hr.
			D831 *	2VLI,3VLI	2VLP, 3VLP	1,1.5,2 Hr.
			D832 *	1.5VLI,2VLI,3VLI	1.5VLP, 2VLP, 3VLP	1,1.5,2,3 Hr.
			D833 *	1.5VLI,2VLI,3VLI	2VLP, 3VLP	1.5 Hr.
			D858	2VLI,3VLI	2VLP, 3VLP	1,1.5,2,4 Hr.
			D871 *	2VLI,3VLI	2VLP, 3VLP	1,1.5,2,3 Hr.
		2 1/2" NW	D864	3VLI	3VLP	1.5 Hr.
	3 1/4" LW	D860 *	2VLI,3VLI		1,1.5,2 Hr.	
	Unprotected Deck	4 3/16" LW	D902 #	1.5VL,1.5VLI,2VLI,3VLI	1.5VLP, 2VLP, 3VLP	1,1.5 Hr.
			D916 #	1.5VL,1.5VLI,2VLI,3VLI	1.5VLP, 2VLP, 3VLP	1,1.5,2,3 Hr.
			D918 #	1.5VL,1.5VLI,2VLI,3VLI	1.5VLP, 2VLP, 3VLP	1,1.5 Hr.
			D919 #	1.5VL,1.5VLI,2VLI,3VLI	1.5VLP, 2VLP, 3VLP	1,1.5 Hr.
		5 1/4" NW	D902 #	1.5VL,1.5VLI,2VLI,3VLI	1.5VLP, 2VLP, 3VLP	1,1.5 Hr.
			D916 #	1.5VL,1.5VLI,2VLI,3VLI	1.5VLP, 2VLP, 3VLP	1,1.5,2,3 Hr.
			D918 #	1.5VL,1.5VLI,2VLI,3VLI	1.5VLP, 2VLP, 3VLP	1,1.5 Hr.
D919 #			1.5VL,1.5VLI,2VLI,3VLI	1.5VLP, 2VLP, 3VLP	1,1.5 Hr.	
4 Hr.	Cementitious	2 1/2" NW&LW	D760	2VLI,3VLI		1,1.5,2,3,4 Hr.
		D739	1.5VLI,2VLI,3VLI	1.5VLP, 2VLP, 3VLP	1,1.5,2,3,4 Hr.	
		3 1/4" LW	D754	1.5VLI,2VLI,3VLI		1.5,2 Hr.
	Sprayed Fiber	2 1/2" NW&LW	D858	2VLI,3VLI	2VLP, 3VLP	1,1.5,2,4 Hr.
		3 1/4" LW	D860	2VLI,3VLI		1,1.5,2 Hr.

See Page 54 for notes.

COMPOSITE

DIAPHRAGM DESIGN

Diaphragm design information for Vulcraft roof and floor decks is based on the Steel Deck Institute “Diaphragm Design Manual, Third Edition” (DDM03) specified by ANSI/SDI RD1.0, NC1.0 and C-2011 in accordance with 2015 IBC Section 2210.

ROOF DECK

Historically, published diaphragm design tables for roof deck have been based on diaphragm shear loads only. These historical tables have not considered the condition of wind uplift in conjunction with diaphragm shear due to wind loads. When support fasteners must resist a significant amount of tension load due to wind uplift, the allowable shear strength of those fasteners is reduced. As net wind uplift increases, allowable diaphragm shear capacity decreases. The effects of uplift are currently included in the diaphragm tables in the Vulcraft catalogs for the PunchLok II System and DoveTail Deck.

Vulcraft Diaphragm Calculator: Vulcraft is pleased to introduce the Vulcraft Diaphragm Calculator to assist in the determination of diaphragm capacity and stiffness of decks without fill. The Diaphragm Calculator can determine capacity governed by seismic, wind only, or wind in conjunction with uplift. Access the diaphragm calculator at: www.vulcraft.com.

Diaphragm Design Resources: Additional diaphragm design information for Vulcraft roof decks is available at www.vulcraft.com, including:

- Vulcraft PunchLok II System Catalogs
- Vulcraft DoveTail Deck Catalogs
- Legacy Roof Deck Diaphragm Tables

DESIGN EXAMPLE

The Vulcraft PunchLok II System is used to illustrate the basic issues involved in the determining roof deck diaphragm capacity and stiffness. See page 10 of this catalog for additional information on the PunchLok II System.

Design Criteria: The objective is to select the deck system for the roof of a warehouse building. The roof structure is constructed of steel joists with top chord thicknesses from 1/8” to 3/16”. The joist spacing is 5’-0” o.c. The contractor has requested 1½” deep PLB deck attached to the supports with power actuated mechanical fasteners. ASD is the basis of design.

The design criteria are as follows:

- Net Wind Uplift Load = 60 psf
- Required Diaphragm Strength (Seismic) = 525 plf
- Required Diaphragm Strength (Wind) = 575 plf (MWFRS)
- Required Diaphragm Stiffness = 60 k/in

Diaphragm Capacity and Stiffness: Start by selecting the appropriate power actuated fastener based on the substrate thickness. Consider Hilti X-HSN 24 fasteners for this example. Based on the selected fastener, use the [Vulcraft PunchLok II Roof Deck Catalog](#) for Hilti Support Connections (pg 40) to determine the capacity and stiffness of 22 gage 1.5PLB roof deck.

Check Seismic Capacity –

Start by checking seismic capacity.

Deck Type = 1.5PLB22

Deck Span = 5'-0"

Substrate Thickness = $\geq 1/8"$ and $\leq 3/16"$

Selected Fastener = Hilti X-HSN 24

Fastener Substrate Range = $\geq 1/8"$ and $\leq 3/8"$ ∴ OK

Support Fastener Attachment Pattern = 36/7

Number of VSC2's required per Span = 3

Allowable Diaphragm Shear Strength = 645 plf > 525 plf ∴ OK

Check Wind Capacity –

When checking diaphragms for wind, uplift should also be considered. Note that components and cladding pressure is used for deck and fastener uplift checks (outside the scope of this example). MWFRS pressure is used for diaphragm interaction. In this example, the roof has a significant net wind uplift pressure; therefore shear/tension interaction must be checked.

Net Wind Uplift Load = 60 psf

Support Fastener Attachment Pattern = 36/7

Number of VSC2's required per Span = 4

Allowable Diaphragm Shear Strength = 592 plf > 575 plf ∴ OK

Check Diaphragm Stiffness –

Since wind requires more PunchLok II System sidelap connections (VSC2's) per span, it will be used to verify that the diaphragm meets the stiffness requirements of the project.

Diaphragm Stiffness, $G' = 61 \text{ k/in} > 60 \text{ k/in} \therefore \text{OK}$

Summarize Design –

The following design meets the project design requirements:

Deck Type = 1.5PLB22

Deck Span = 5'-0"

Substrate Thickness = $\geq 1/8"$ and $\leq 3/16"$

Selected Fastener = Hilti X-HSN 24

Fastener Substrate Range = $\geq 1/8"$ and $\leq 3/8"$ ∴ OK

Support Fastener Attachment Pattern = 36/7

Number of VSC2's required per Span = 4

Allowable Seismic Diaphragm Shear Strength = 751 plf > 525 plf ∴ OK

Allowable Diaphragm Shear Strength with 60 psf Net Wind Uplift = 592 plf > 575 plf ∴ OK

Diaphragm Stiffness, $G' = 61 \text{ k/in} > 60 \text{ k/in} \therefore \text{OK}$

Please note that the parallel attachments must be designed to complete the diaphragm design.

Refer to pg 16 of [Vulcraft PunchLok II Roof Deck Catalog](#)

VULCRAFT DIAPHRAGM CALCULATOR

The online Vulcraft Diaphragm Calculator allows easy determination of unfilled deck diaphragm strength and stiffness. The calculator is based on the Steel Deck Institute “Diaphragm Design Manual, Third Edition” (DDM03) specified by ANSI/SDI RD1.0, NC1.0 and C-2011 in accordance with 2015 IBC Section 2210. The Diaphragm Calculator can be accessed at: <http://www.vulcraft.com/design-tools>.

Use Vulcraft’s Diaphragm Calculator because it:

- Expands scope of published tables by creating customized diaphragm tables using selected fasteners, patterns, and table ranges.
- Provides detailed calculations for user defined specific conditions.
- Allows choice of ASD, LRFD, or LSD design.
- Includes roof deck as well as non-composite and composite decks without fill.
- Determines seismic diaphragm strength, wind diaphragm strength in combination with uplift, and diaphragm stiffness.
- Includes PunchLok II system values for applicable profiles

Vulcraft Deck Diaphragm Shear & Stiffness

Per SDI DDM03

In accordance with 2015 IBC Section 2210 ANSI/SDI RD-1.0, NC1.0 & C-2011



Input Design Criteria

Unit System	Imperial	Support Fastener Type	5/8" Visible Arc Spot Weld
Design Method	ASD		
Deck Option	Roof Deck	Support Member	A572 Grade 50
Deck Type	1.5B-36	Perpendicular Attachment Pattern	36 / 4
Deck Gage	20	Sidelap Fastener Type	#10 Screw
Deck Grade	Grade 33	Table Generator Formatting:	
Number of Spans	3	Tables Generated Based on	
MWFRS Net Wind Uplift (psf)	0.00	Num. of Sidelap Fasteners per Span	
		Start Number of Sidelap Fasteners per Span at	1
		Start Table at Span of (ft.)	3.00
		Spans Increment at (ft.)	0.50

To facilitate the determination of diaphragm performance, the Vulcraft Diaphragm Calculator:

- Simplifies complex wind uplift / shear interaction calculations.
- Calculates required number of edge fasteners based on selected attachment patterns.
- Includes welds, screws and PAF support connections.
- Includes VSC2’s (PunchLok system), welds, screws, and button punched sidelap connections.
- Allows definition of sidelap connections by either quantity/span or by spacing.

DECKS WITH INSULATING FILL AND STRUCTURAL CONCRETE FILL

Diaphragm load tables for Vulcraft Non-Composite and Composite floor decks are provided for the following conditions:

Non-Composite Floor Deck:

0.6C, 1.0C and 1.3C Decks with Insulating Fill using SDI Type I and Type II construction; and, with light weight and normal weight structural concrete

Composite Floor Deck:

1.5VLI, 2VLI, and 3VLI Decks with light weight and normal weight structural concrete

The Steel Deck Institute has done testing that allows prediction of deck-fill combinations. One combination is lightweight insulating fill. Type I fill uses vermiculite concrete, 2½ inches deep over the deck, while Type II includes a rigid insulation board with two or more inches of vermiculite concrete over the top. The tables with structural concrete are based on a minimum of 2½ inches of cover over the top of the deck.

This catalog is not presented as an alternative to the use of the Steel Deck Institute “Diaphragm Design Manual, Third Edition” (DDM03), but as an extension to it for our decks. We have shown the shear strength and stiffness of our various decks, but not the backup data behind these calculations. DDM03 does a good job of supplying that information.

These tables were derived based on the following assumptions:

1. All values are for a three span condition.
2. The values for filled diaphragms are based on a factor of safety of 3.25.
3. The number of fasteners are the same at both end members and interior supports. Example: 36/7 means 36 inch wide deck with 7 fasteners per support.
4. Where welds are shown at the supports, only use weld washers on deck thicknesses less than 0.028”. Weld washers should be 16 gage with a 3/8” hole in them.
5. The number of intermediate sidelap (stitch) connectors is assumed to be the same as the number of extreme edge fasteners.
6. Where welded sidelaps are shown, either use a 5/8” puddle weld or a 3/8” x 1¼” arc seam weld. Use appropriate welding procedures to avoid burn through in thinner deck gages.
7. The column shown as “# OF SIDELAP FASTENERS”, contains the number of sidelap fasteners per span. That is, if the line that is selected has 4 and the span is five feet, then it will be one fastener per foot in the sidelap.
8. Deck sidelaps should be fastened at a maximum spacing of 36” o.c. for construction loading and fire resistance ratings, regardless of the spacing required for diaphragm strength. Button-punches on interlocking deck may be used to meet this requirement even though they are not considered in the development of shear strength.
9. Lightweight fill (vermiculite) should be placed only on slot vented deck (type CSV).

TYPICAL FASTENER LAYOUT

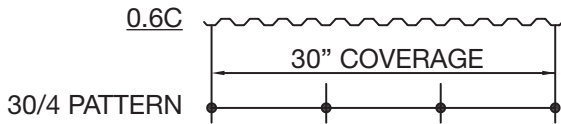
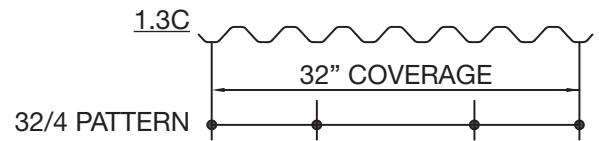
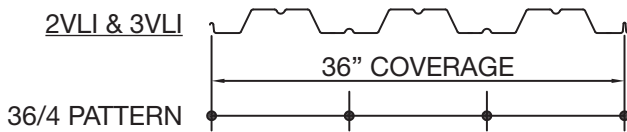
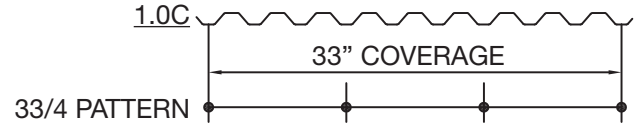
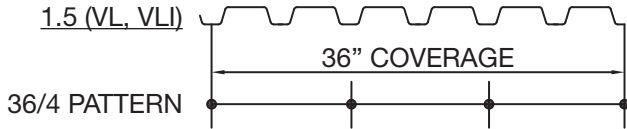

DIAPHRAGM SHEAR STRENGTH AND STIFFNESS DESIGN EXAMPLE

Joist Spacing = 3'-0"
Deck: 26 gage 0.6CSV Deck with Type I Insulating Fill in 15'-0" panels
Fasteners:

Support: 30/4 Pattern - #12 TEK Screws
Sidelape: 1 - #12 TEK Screws

From diaphragm strength tables: $K_1 = 0.517$, $K_2 = 530$, $K_3 = 260$

$$G' = \frac{K_2}{3.20 + 3K_1 \text{ Span}} + K_3 = \frac{530}{3.20 + 3(0.517)(3)} + 260 = 327 \text{ K/in}$$

$$\Delta \zeta = \frac{WL^2}{8xBxG'} = \frac{0.305(100)^2}{8(45)(327)} = 0.026 \text{ in}$$

Strength Check:

$$R = WL/2 = \frac{305(100)}{2} = 15250 \text{ lbs} \quad S = \frac{15250}{45} = 339 \text{ plf} < 340 \text{ plf (from page 65) OK}$$

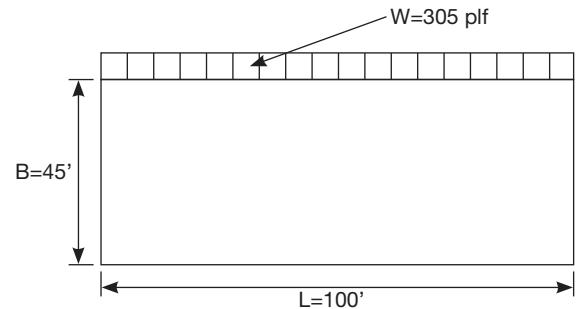

DIAPHRAGM

0.6C, 1.0C, & 1.3C DECK with NORMAL WEIGHT CONCRETE

• Support Fasteners: Welds with Weld Washers

• Sidelap Fasteners: #10 Screws

0.6C with 30/4 Attachment Pattern

1.0C with 33/4 Attachment Pattern

1.3C with 32/4 Attachment Pattern

$\gamma_{con} = 145 \text{ pcf}$

$f_c = 3000 \text{ psi}$

$t_{min} = 2.5'' \text{ (min.)}$

Factor of Safety = 3.25

Deck Gage	# of Sidelap Fasteners	Allowable Diaphragm Shear Strength (plf)										K1	K2
		Span Length (ft-in.)											
		1'-6"	2'-0"	2'-6"	3'-0"	3'-6"	4'-0"	4'-6"	5'-0"	5'-6"	6'-0"		
28 ¹	0	1873	1782	1728	1691	1665	1646	1630	1618			0.621	440
	1	1939	1832	1767	1724	1693	1670	1652	1638	1626	1617	0.434	
	2	2005	1881	1806	1757	1721	1695	1674	1658	1644	1633	0.334	
	3	2070	1930	1846	1790	1750	1719	1696	1677	1662	1649	0.271	
	4	2136	1979	1885	1822	1778	1744	1718	1697	1680	1666	0.228	
	5	2202	2028	1925	1855	1806	1769	1740	1717	1698	1682	0.197	
26	0	1981	1863	1792	1745	1711	1686	1666	1651			0.681	530
	1	2060	1922	1839	1784	1745	1715	1693	1674	1659	1647	0.476	
	2	2138	1981	1887	1824	1779	1745	1719	1698	1681	1666	0.366	
	3	2217	2040	1934	1863	1813	1775	1745	1721	1702	1686	0.297	
	4	2296	2099	1981	1903	1846	1804	1771	1745	1724	1706	0.250	
	5	2375	2158	2029	1942	1880	1834	1798	1769	1745	1725	0.216	
24	0	2229	2049	1941	1869	1818	1779	1749	1725			0.787	700
	1	2335	2128	2004	1922	1863	1819	1784	1757	1734	1715	0.550	
	2	2440	2207	2068	1974	1908	1858	1819	1788	1763	1742	0.422	
	3	2545	2286	2131	2027	1953	1898	1854	1820	1792	1768	0.343	
	4	2650	2365	2194	2080	1998	1937	1890	1851	1820	1794	0.289	
	5	2756	2444	2257	2132	2043	1977	1925	1883	1849	1821	0.249	

K3 = 2380

0.6C, 1.0C, & 1.3C DECK with NORMAL WEIGHT CONCRETE

• Support Fasteners: #12 Screws

• Sidelap Fasteners: #10 Screws

0.6C with 30/4 Attachment Pattern

1.0C with 33/4 Attachment Pattern

1.3C with 32/4 Attachment Pattern

$\gamma_{conc} = 145 \text{ pcf}$

$f_c = 3000 \text{ psi}$

$t_{min} = 2.5'' \text{ (min.)}$

Factor of Safety = 3.25

Deck Gage	# of Sidelap Fasteners	Allowable Diaphragm Shear Strength (plf)										K1	K2
		Span Length (ft-in.)											
		1'-6"	2'-0"	2'-6"	3'-0"	3'-6"	4'-0"	4'-6"	5'-0"	5'-6"	6'-0"		
28 ¹	0	1781	1713	1672	1645	1625	1611	1600	1591	1583	1577	0.702	440
	1	1846	1762	1711	1678	1654	1636	1621	1610	1601	1593	0.472	
	2	1912	1811	1751	1710	1682	1660	1643	1630	1619	1610	0.356	
	3	1978	1860	1790	1743	1710	1685	1665	1650	1637	1626	0.285	
	4	2043	1910	1830	1776	1738	1709	1687	1669	1655	1643	0.238	
	5	2109	1959	1869	1809	1766	1734	1709	1689	1673	1659	0.204	
26	0	1835	1754	1705	1672	1649	1631	1618	1607	1598	1591	0.770	530
	1	1914	1813	1752	1712	1683	1661	1644	1631	1620	1610	0.517	
	2	1993	1872	1799	1751	1716	1691	1670	1654	1641	1630	0.390	
	3	2072	1931	1847	1790	1750	1720	1697	1678	1663	1650	0.313	
	4	2043	1910	1830	1776	1738	1709	1687	1669	1655	1643	0.238	
	5	2230	2049	1941	1869	1818	1779	1749	1725	1706	1689	0.224	
24	0	1945	1836	1770	1727	1696	1672	1654	1640	1628	1618	0.889	700
	1	2050	1915	1834	1780	1741	1712	1689	1671	1657	1644	0.598	
	2	2155	1994	1897	1832	1786	1751	1724	1703	1685	1671	0.450	
	3	2261	2073	1960	1885	1831	1791	1760	1734	1714	1697	0.361	
	4	2366	2152	2023	1937	1876	1830	1795	1766	1743	1723	0.301	
	5	2471	2231	2086	1990	1921	1870	1830	1798	1771	1750	0.259	

K3 = 2380

¹ 1.3C is not available in 28 gage.

$$G' = \frac{K2}{3.2 + 3 * K1 * \text{Span}} + K3, \text{ kips/in} \quad \text{Note: SPAN is in feet.}$$

0.6C, 1.0C, & 1.3C DECK with LIGHT WEIGHT CONCRETE

• Support Fasteners: Welds with Weld Washers

• Sidelap Fasteners: #10 Screws

0.6C with 30/4 Attachment Pattern

1.0C with 33/4 Attachment Pattern

1.3C with 32/4 Attachment Pattern

$\gamma_{conc} = 110$ pcf

$f'_c = 3000$ psi

$t_{min} = 2.5''$ (min.)

Factor of Safety = 3.25

Deck Gage	# of Sidelap Fasteners	Allowable Diaphragm Shear Strength (plf)										K1	K2
		Span Length (ft-in.)											
		1'-6"	2'-0"	2'-6"	3'-0"	3'-6"	4'-0"	4'-6"	5'-0"	5'-6"	6'-0"		
28'	0	1361	1270	1216	1179	1153	1134	1119	1106			0.621	440
	1	1427	1320	1255	1212	1181	1158	1140	1126	1114	1105	0.434	
	2	1493	1369	1294	1245	1210	1183	1162	1146	1132	1121	0.334	
	3	1558	1418	1334	1278	1238	1208	1184	1165	1150	1137	0.271	
	4	1624	1467	1373	1311	1266	1232	1206	1185	1168	1154	0.228	
	5	1690	1516	1413	1343	1294	1257	1228	1205	1186	1170	0.197	
26	0	1469	1351	1280	1233	1199	1174	1154	1139			0.681	530
	1	1548	1410	1327	1272	1233	1204	1181	1162	1147	1135	0.476	
	2	1626	1469	1375	1312	1267	1233	1207	1186	1169	1154	0.366	
	3	1705	1528	1422	1351	1301	1263	1233	1210	1190	1174	0.297	
	4	1624	1467	1373	1311	1266	1232	1206	1185	1168	1154	0.228	
	5	1863	1646	1517	1430	1368	1322	1286	1257	1233	1214	0.216	
24	0	1717	1537	1429	1357	1306	1267	1237	1213			0.787	700
	1	1823	1616	1492	1410	1351	1307	1272	1245	1222	1204	0.550	
	2	1928	1695	1556	1463	1396	1346	1307	1276	1251	1230	0.422	
	3	2033	1774	1619	1515	1441	1386	1342	1308	1280	1256	0.343	
	4	2139	1853	1682	1568	1486	1425	1378	1340	1308	1282	0.289	
	5	2244	1932	1745	1620	1531	1465	1413	1371	1337	1309	0.249	

K3 = 2380

0.6C, 1.0C, & 1.3C DECK with LIGHT WEIGHT CONCRETE

• Support Fasteners: #12 Screws

• Sidelap Fasteners: #10 Screws

0.6C with 30/4 Attachment Pattern

1.0C with 33/4 Attachment Pattern

1.3C with 32/4 Attachment Pattern

$\gamma_{conc} = 110$ pcf

$f'_c = 3000$ psi

$t_{min} = 2.5''$ (min.)

Factor of Safety = 3.25

Deck Gage	# of Sidelap Fasteners	Allowable Diaphragm Shear Strength (plf)										K1	K2
		Span Length (ft-in.)											
		1'-6"	2'-0"	2'-6"	3'-0"	3'-6"	4'-0"	4'-6"	5'-0"	5'-6"	6'-0"		
28'	0	1269	1201	1160	1133	1114	1099	1088	1079			0.702	440
	1	1334	1250	1199	1166	1142	1124	1110	1098	1089	1081	0.472	
	2	1400	1299	1239	1199	1170	1148	1131	1118	1107	1098	0.356	
	3	1466	1348	1278	1231	1198	1173	1153	1138	1125	1114	0.285	
	4	1531	1398	1318	1264	1226	1197	1175	1157	1143	1131	0.238	
	5	1597	1447	1357	1297	1254	1222	1197	1177	1161	1147	0.204	
26	0	1323	1242	1193	1160	1137	1119	1106	1095			0.770	530
	1	1402	1301	1240	1200	1171	1149	1132	1119	1108	1098	0.517	
	2	1481	1360	1288	1239	1205	1179	1158	1142	1129	1118	0.390	
	3	1560	1419	1335	1279	1238	1208	1185	1166	1151	1138	0.313	
	4	1639	1478	1382	1318	1272	1238	1211	1190	1172	1158	0.261	
	5	1718	1538	1429	1357	1306	1267	1237	1213	1194	1177	0.224	
24	0	1433	1324	1259	1215	1184	1161	1142	1128			0.889	700
	1	1538	1403	1322	1268	1229	1200	1177	1159	1145	1132	0.598	
	2	1643	1482	1385	1320	1274	1239	1213	1191	1173	1159	0.450	
	3	1749	1561	1448	1373	1319	1279	1248	1223	1202	1185	0.361	
	4	1854	1640	1511	1425	1364	1318	1283	1254	1231	1211	0.301	
	5	1959	1719	1574	1478	1409	1358	1318	1286	1259	1238	0.259	

K3 = 2380

¹ 1.3C is not available in 28 gage.

NOTE: See page 61 for G' calculation

0.6CSV & 1.0CSV DECK with TYPE I INSULATING FILL

• Support Fasteners: Welds

• Sidelap Fasteners: #10 Screws

0.6CSV with 30/4 Attachment Pattern

$f_c = 125$ psi

1.0CSV with 33/4 Attachment Pattern

$t_{min} = 2.5"$ (min.)

Factor of Safety = 3.25

Deck Gage	# of Sidelap Fasteners	Allowable Diaphragm Shear Strength (plf)										K1		K2	K3
		Span Length (ft-in.)										0.6CSV	1.0CSV		
		1'-6"	2'-0"	2'-6"	3'-0"	3'-6"	4'-0"	4'-6"	5'-0"	5'-6"	6'-0"				
28	0	502	411	356	320	294	274	259	247			0.621	0.565	440	260
	1	568	460	396	353	322	299	281	267	255	245	0.434	0.395		
	2	633	509	435	385	350	323	303	286	273	262	0.334	0.303		
	3	699	559	474	418	378	348	325	306	291	278	0.271	0.246		
	4	764	608	514	451	406	373	347	326	309	294	0.228	0.207		
	5	830	657	553	484	434	397	368	345	326	311	0.197	0.179		
26	0	609	491	421	373	340	314	295	279			0.681	0.619	530	260
	1	688	551	468	413	374	344	321	303	288	275	0.476	0.432		
	2	767	610	515	452	407	374	347	326	309	295	0.366	0.332		
	3	846	669	563	492	441	403	374	350	331	315	0.297	0.270		
	4	925	728	610	531	475	433	400	374	352	334	0.250	0.227		
	5	1003	787	657	571	509	462	426	397	374	354	0.216	0.196		
24	0	858	678	570	498	446	408	378	354			0.787	0.715	700	260
	1	963	757	633	550	491	447	413	385	363	344	0.550	0.500		
	2	1069	836	696	603	537	487	448	417	391	370	0.422	0.384		
	3	1174	915	759	656	582	526	483	448	420	397	0.343	0.312		
	4	1279	994	822	708	627	566	518	480	449	423	0.289	0.262		
	5	1384	1073	886	761	672	605	553	512	478	449	0.249	0.227		
22	0	666	534	455	402	364	336	314	296			0.874	0.795	870	260
	1	796	631	533	467	420	385	357	335	317	302	0.611	0.555		
	2	926	729	611	532	475	433	400	374	353	335	0.469	0.427		
	3	1056	826	689	597	531	482	444	413	388	367	0.381	0.346		
	4	1186	924	767	662	587	531	487	452	423	400	0.321	0.292		
	5	1316	1021	844	727	643	579	530	491	459	432	0.277	0.252		

1.3C DECK with TYPE I INSULATING FILL

• Support Fasteners: Welds

• Sidelap Fasteners: #10 Screws

1.3CSV with 32/4 Attachment Pattern

$f_c = 125$ psi

$t_{min} = 2.5"$ (min.)

Factor of Safety = 3.25

Deck Gage	# of Sidelap Fasteners	Allowable Diaphragm Shear Strength (plf)										K1	K2	K3	
		Span Length (ft-in.)													
		1'-6"	2'-0"	2'-6"	3'-0"	3'-6"	4'-0"	4'-6"	5'-0"	5'-6"	6'-0"				
26	0	640	514	439	389	353	326	305	288			0.596		530	260
	1	719	574	486	428	387	356	331	312	296	283	0.425			
	2	798	633	534	468	421	385	358	336	318	303	0.330			
	3	877	692	581	507	454	415	384	359	339	322	0.270			
	4	955	751	628	547	488	444	410	383	361	342	0.228			
	5	1034	810	676	586	522	474	436	407	382	362	0.198			
24	0	905	713	598	521	467	425	393	368			0.688		700	260
	1	1010	792	661	574	512	465	429	399	376	356	0.491			
	2	1116	871	724	627	557	504	464	431	404	382	0.381			
	3	1221	950	788	679	602	544	499	463	433	408	0.312			
	4	1326	1029	851	732	647	583	534	494	462	435	0.264			
	5	1431	1108	914	784	692	623	569	526	490	461	0.229			
22	0	701	560	475	419	379	349	325	307			0.765		870	260
	1	831	657	553	484	435	397	369	345	327	311	0.545			
	2	960	755	631	549	490	446	412	384	362	343	0.424			
	3	1090	852	709	614	546	495	455	423	397	376	0.346			
	4	1220	950	787	679	602	544	499	462	433	408	0.293			
	5	1350	1047	865	744	657	592	542	501	468	441	0.254			
20	0	814	645	543	476	427	391	363	340			0.842		1056	260
	1	971	763	638	554	495	450	416	388	365	346	0.601			
	2	1129	881	732	633	562	509	468	435	408	385	0.467			
	3	1287	999	827	712	630	569	521	482	451	425	0.382			
	4	1444	1118	922	791	698	628	573	530	494	464	0.323			
	5	1602	1236	1016	870	765	687	626	577	537	504	0.280			

NOTE: See page 61 for G' calculation

0.6CSV & 1.0CSV DECK with TYPE I INSULATING FILL

• Support Fasteners: #12 Screws

• Sidelap Fasteners: #10 Screws

0.6CSV with 30/4 Attachment Pattern

1.0CSV with 33/4 Attachment Pattern

$f_c = 125$ psi

$t_{min} = 2.5"$ (min.)

Factor of Safety = 3.25

Deck Gage	# of Sidelap Fasteners	Allowable Diaphragm Shear Strength (plf)										K1		K2	K3
		Span Length (ft-in.)										0.6CSV	1.0CSV		
		1'-6"	2'-0"	2'-6"	3'-0"	3'-6"	4'-0"	4'-6"	5'-0"	5'-6"	6'-0"				
28	0	409	341	301	273	254	239	228	219			0.702	0.638	440	260
	1	475	391	340	306	282	264	250	239	230	222	0.472	0.429		
	2	541	440	379	339	310	289	272	258	247	238	0.356	0.323		
	3	606	489	419	372	338	313	294	278	265	255	0.285	0.259		
	4	672	538	458	405	367	338	316	298	283	271	0.238	0.216		
	5	737	587	497	438	395	363	338	318	301	288	0.204	0.186		
26	0	464	382	333	301	277	260	246	236			0.770	0.700	530	260
	1	543	442	381	340	311	290	273	259	248	239	0.517	0.470		
	2	622	501	428	380	345	319	299	283	270	259	0.390	0.354		
	3	700	560	475	419	379	349	325	306	291	278	0.313	0.284		
	4	779	619	523	458	413	378	352	330	313	298	0.261	0.237		
	5	858	678	570	498	446	408	378	354	334	318	0.224	0.204		
24	0	573	464	399	355	324	301	283	268			0.889	0.808	700	260
	1	679	543	462	408	369	340	318	300	285	273	0.598	0.544		
	2	784	622	525	461	415	380	353	331	314	299	0.450	0.409		
	3	889	701	589	513	460	419	388	363	343	325	0.361	0.328		
	4	994	780	652	566	505	459	423	395	371	352	0.301	0.274		
	5	1100	859	715	619	550	498	458	426	400	378	0.259	0.235		
22	0	675	541	460	407	368	339	317	299			0.988	0.898	870	260
	1	805	638	538	472	424	388	360	338	320	305	0.664	0.604		
	2	935	736	616	536	479	437	404	377	355	337	0.500	0.455		
	3	1065	833	694	601	535	485	447	416	391	370	0.401	0.365		
	4	1195	931	772	666	591	534	490	455	426	402	0.335	0.304		
	5	1325	1028	850	731	647	583	533	494	461	434	0.287	0.261		

1.3C DECK with TYPE I INSULATING FILL

• Support Fasteners: #12 Screws

• Sidelap Fasteners: #10 Screws

1.3CSV with 32/4 Attachment Pattern

$f_c = 125$ psi

$t_{min} = 2.5"$ (min.)

Factor of Safety = 3.25

Deck Gage	# of Sidelap Fasteners	Allowable Diaphragm Shear Strength (plf)										K1	K2	K3	
		Span Length (ft-in.)													
		1'-6"	2'-0"	2'-6"	3'-0"	3'-6"	4'-0"	4'-6"	5'-0"	5'-6"	6'-0"				
26	0	485	398	346	311	287	268	254	242			0.673		530	260
	1	564	458	394	351	320	298	280	266	254	244	0.463			
	2	643	517	441	390	354	327	306	289	275	264	0.353			
	3	722	576	488	430	388	357	332	313	297	284	0.285			
	4	801	635	535	469	422	386	359	337	318	303	0.239			
	5	879	694	583	509	456	416	385	360	340	323	0.206			
24	0	602	486	416	370	337	312	292	277			0.778		700	260
	1	707	565	479	422	382	351	327	308	293	280	0.535			
	2	812	644	542	475	427	391	363	340	322	306	0.407			
	3	918	723	606	528	472	430	398	372	350	333	0.329			
	4	1023	802	669	580	517	470	433	403	379	359	0.276			
	5	1128	881	732	633	562	509	468	435	408	385	0.238			
22	0	711	567	481	424	383	352	329	310			0.865		870	260
	1	841	665	559	489	439	401	372	348	329	313	0.594			
	2	970	762	637	554	495	450	415	387	365	346	0.453			
	3	1100	860	715	619	550	499	459	426	400	378	0.366			
	4	1230	957	793	684	606	547	502	465	436	411	0.307			
	5	1360	1055	871	749	662	596	545	504	471	443	0.264			
20	0	833	659	555	485	436	398	369	346			0.952		1056	260
	1	991	777	649	564	503	458	422	394	370	351	0.655			
	2	1148	896	744	643	571	517	475	441	413	390	0.499			
	3	1306	1014	839	722	638	576	527	488	456	430	0.403			
	4	1464	1132	933	801	706	635	580	535	499	469	0.338			
	5	1621	1250	1028	879	773	694	632	583	542	509	0.291			

NOTE: See page 61 for G' calculation

0.6CSV & 1.0CSV DECK with TYPE II INSULATING FILL

• Support Fasteners: Welds

• Sidelap Fasteners: #10 Screws

0.6CSV with 30/4 Attachment Pattern

1.0CSV with 33/4 Attachment Pattern

$f_c = 125$ psi

$t_{min} = 2.5"$ (min.)

Factor of Safety = 3.25

Deck Gage	# of Sidelap Fasteners	Allowable Diaphragm Shear Strength (plf)										K1		K2	K3
		Span Length (ft-in.)										0.6CSV	1.0CSV		
		1'-6"	2'-0"	2'-6"	3'-0"	3'-6"	4'-0"	4'-6"	5'-0"	5'-6"	6'-0"				
28	0	585	493	439	402	376	357	342	329			0.621	0.565	440	260
	1	650	543	478	435	404	381	364	349	337	328	0.434	0.395		
	2	716	592	518	468	433	406	385	369	355	344	0.334	0.303		
	3	781	641	557	501	461	431	407	389	373	360	0.271	0.246		
	4	847	690	596	534	489	455	429	408	391	377	0.228	0.207		
	5	913	740	636	566	517	480	451	428	409	393	0.197	0.179		
26	0	692	574	503	456	422	397	377	362			0.681	0.619	530	260
	1	771	633	550	495	456	427	404	385	370	358	0.476	0.432		
	2	850	692	598	535	490	456	430	409	392	378	0.366	0.332		
	3	928	751	645	574	524	486	456	433	413	397	0.297	0.270		
	4	1007	810	692	614	557	515	483	456	435	417	0.250	0.227		
	5	1086	870	740	653	591	545	509	480	456	437	0.216	0.196		
24	0	941	760	652	580	529	490	460	436			0.787	0.715	700	260
	1	1046	839	716	633	574	530	495	468	445	427	0.550	0.500		
	2	1151	918	779	686	619	569	530	499	474	453	0.422	0.384		
	3	1256	997	842	738	664	609	566	531	503	479	0.343	0.312		
	4	1362	1076	905	791	709	648	601	563	531	506	0.289	0.262		
	5	1467	1155	968	844	754	688	636	594	560	532	0.249	0.227		
22	0	749	617	537	484	447	418	396	379			0.874	0.795	870	260
	1	879	714	615	549	502	467	440	418	400	385	0.611	0.555		
	2	1009	811	693	614	558	516	483	457	435	417	0.469	0.427		
	3	1138	909	771	679	614	565	526	496	471	450	0.381	0.346		
	4	1268	1006	849	744	669	613	570	535	506	482	0.321	0.292		
	5	1398	1104	927	809	725	662	613	574	541	515	0.277	0.252		

1.3C DECK with TYPE II INSULATING FILL

• Support Fasteners: Welds

• Sidelap Fasteners: #10 Screws

1.3CSV with 32/4 Attachment Pattern

$f_c = 125$ psi

$t_{min} = 2.5"$ (min.)

Factor of Safety = 3.25

Deck Gage	# of Sidelap Fasteners	Allowable Diaphragm Shear Strength (plf)										K1	K2	K3	
		Span Length (ft-in.)													
		1'-6"	2'-0"	2'-6"	3'-0"	3'-6"	4'-0"	4'-6"	5'-0"	5'-6"	6'-0"				
26	0	723	597	522	471	436	409	388	371			0.596		530	260
	1	802	656	569	511	469	438	414	395	379	366	0.425			
	2	880	715	616	550	503	468	440	418	400	385	0.330			
	3	959	774	664	590	537	497	467	442	422	405	0.270			
	4	1038	834	711	629	571	527	493	466	443	425	0.228			
	5	1117	893	758	669	604	556	519	489	465	444	0.198			
24	0	988	796	681	604	549	508	476	450			0.688		700	260
	1	1093	875	744	657	594	547	511	482	458	438	0.491			
	2	1198	954	807	709	639	587	546	514	487	465	0.381			
	3	1303	1033	870	762	684	626	581	545	516	491	0.312			
	4	1409	1112	933	814	730	666	616	577	544	517	0.264			
	5	1514	1190	996	867	775	705	651	608	573	544	0.229			
22	0	783	642	558	502	461	431	408	389			0.765		870	260
	1	913	740	636	567	517	480	451	428	409	393	0.545			
	2	1043	837	714	632	573	529	494	467	445	426	0.424			
	3	1173	935	792	697	629	577	538	506	480	458	0.346			
	4	1303	1032	870	762	684	626	581	545	515	491	0.293			
	5	1433	1130	948	826	740	675	624	584	551	523	0.254			
20	0	896	727	626	558	510	474	446	423			0.842		1056	260
	1	1054	845	720	637	577	533	498	470	448	429	0.601			
	2	1212	964	815	716	645	592	551	518	491	468	0.467			
	3	1369	1082	910	795	713	651	603	565	534	507	0.382			
	4	1527	1200	1004	874	780	710	656	612	577	547	0.323			
	5	1685	1318	1099	952	848	769	708	659	620	586	0.280			

NOTE: See page 61 for G' calculation

0.6CSV & 1.0CSV DECK with TYPE II INSULATING FILL

• Support Fasteners: #12 Screws

• Sidelap Fasteners: #10 Screws

0.6CSV with 30/4 Attachment Pattern

1.0CSV with 33/4 Attachment Pattern

$f_c = 125$ psi

$t_{min} = 2.5"$ (min.)

Factor of Safety = 3.25

Deck Gage	# of Sidelap Fasteners	Allowable Diaphragm Shear Strength (plf)										K1			K2	K3
		Span Length (ft-in.)										0.6CSV	1.0CSV			
		1'-6"	2'-0"	2'-6"	3'-0"	3'-6"	4'-0"	4'-6"	5'-0"	5'-6"	6'-0"	0.6CSV	1.0CSV			
28	0	492	424	383	356	337	322	311	302			0.702	0.638	440	260	
	1	557	473	423	389	365	347	333	321	312	304	0.472	0.429			
	2	623	522	462	422	393	371	354	341	330	321	0.356	0.323			
	3	689	572	501	454	421	396	376	361	348	337	0.285	0.259			
	4	754	621	541	487	449	420	398	380	366	354	0.238	0.216			
	5	820	670	580	520	477	445	420	400	384	370	0.204	0.186			
26	0	547	465	416	383	360	343	329	318			0.770	0.700	530	260	
	1	625	524	463	423	394	372	355	342	331	321	0.517	0.470			
	2	704	583	511	462	428	402	382	365	352	341	0.390	0.354			
	3	783	642	558	502	461	431	408	389	374	361	0.313	0.284			
	4	862	701	605	541	495	461	434	413	395	381	0.261	0.237			
	5	941	761	653	580	529	490	460	436	417	400	0.224	0.204			
24	0	656	547	482	438	407	384	365	351			0.889	0.808	700	260	
	1	761	626	545	491	452	423	401	382	368	355	0.598	0.544			
	2	866	705	608	543	497	463	436	414	396	382	0.450	0.409			
	3	972	784	671	596	542	502	471	446	425	408	0.361	0.328			
	4	1077	863	734	649	587	541	506	477	454	434	0.301	0.274			
	5	1182	942	797	701	632	581	541	509	483	461	0.259	0.235			
22	0	758	624	543	489	451	422	399	382			0.988	0.898	870	260	
	1	888	721	621	554	506	471	443	421	402	387	0.664	0.604			
	2	1018	818	699	619	562	519	486	459	438	420	0.500	0.455			
	3	1148	916	777	684	618	568	529	498	473	452	0.401	0.365			
	4	1278	1013	855	749	673	617	573	537	509	485	0.335	0.304			
	5	1408	1111	933	814	729	665	616	576	544	517	0.287	0.261			

1.3C DECK with TYPE II INSULATING FILL

• Support Fasteners: #12 Screws

• Sidelap Fasteners: #10 Screws

1.3CSV with 32/4 Attachment Pattern

$f_c = 125$ psi

$t_{min} = 2.5"$ (min.)

Factor of Safety = 3.25

Deck Gage	# of Sidelap Fasteners	Allowable Diaphragm Shear Strength (plf)										K1	K2	K3	
		Span Length (ft-in.)													
		1'-6"	2'-0"	2'-6"	3'-0"	3'-6"	4'-0"	4'-6"	5'-0"	5'-6"	6'-0"				
26	0	568	481	429	394	369	351	336	324			0.673		530	260
	1	647	540	476	433	403	380	362	348	336	327	0.463			
	2	726	599	523	473	437	410	389	372	358	347	0.353			
	3	804	658	571	512	471	439	415	395	379	366	0.285			
	4	883	717	618	552	504	469	441	419	401	386	0.239			
	5	962	777	665	591	538	498	467	443	422	406	0.206			
24	0	684	568	499	452	419	394	375	359			0.778		700	260
	1	790	647	562	505	464	434	410	391	375	363	0.535			
	2	895	726	625	558	509	473	445	423	404	389	0.407			
	3	1000	805	688	610	554	513	480	454	433	415	0.329			
	4	1105	884	751	663	600	552	515	486	462	441	0.276			
	5	1211	963	814	715	645	592	550	517	490	468	0.238			
22	0	793	650	564	507	466	435	411	392			0.865		870	260
	1	923	747	642	572	521	484	454	431	412	396	0.594			
	2	1053	845	720	637	577	532	498	470	447	428	0.453			
	3	1183	942	798	702	633	581	541	509	483	461	0.366			
	4	1313	1040	876	767	688	630	584	548	518	493	0.307			
	5	1443	1137	954	831	744	679	628	587	554	526	0.264			
20	0	916	742	637	568	518	481	452	429			0.952		1056	260
	1	1073	860	732	647	586	540	505	476	453	433	0.655			
	2	1231	978	827	726	653	599	557	523	496	473	0.499			
	3	1389	1096	921	804	721	658	610	571	539	512	0.403			
	4	1546	1215	1016	883	788	717	662	618	582	552	0.338			
	5	1704	1333	1110	962	856	777	715	665	625	591	0.291			

NOTE: See page 61 for G' calculation

1.5, 2 & 3 COMPOSITE DECK with NORMAL WEIGHT CONCRETE

- Support Fasteners: 5/8" Puddle Welds
- Sidelap Fasteners: Welded¹

$$\gamma_{conc} = 145 \text{ pcf}$$

$$f_c = 3000 \text{ psi}$$

$$t_{min} = 2.5" \text{ (min.)}$$

Factor of Safety = 3.25

36/4 Attachment Pattern

Deck Gage	# of Sidelap Fasteners	Allowable Diaphragm Shear Strength (plf)										K1	K2	
		Span Length (ft-in.)												
		6'-0"	7'-0"	8'-0"	9'-0"	10'-0"	11'-0"	12'-0"	13'-0"	14'-0"	15'-0"			
22	0	1641	1622	1608	1597	1588	1581	1575	1570	1566	1562	0.728	870	
	1	1708										0.358		
	2	1775	1737	1708	1686							0.237		
	3	1842	1794	1759	1731	1709	1691	1675						0.177
	4	1909	1852	1809	1775	1749	1727	1709	1693	1680	1669	0.142		
	5	1976	1909	1819	1820	1789	1764	1742	1724	1709	1696	0.118		
	6	2042	1966	1909	1885	1829	1800	1755	1755	1738	1722	0.101		
	7	2109	2024	1959	1909	1869	1836	1809	1786	1766	1749	0.088		
	8	2176	2081	2009	1954	1909	1873	1843	1817	1795	1776	0.078		
	9	2243	2138	2060	1998	1950	1909	1876	1848	1824	1803	0.071		
10	2310	2196	2110	2043	1990	1946	1910	1879	1852	1829	0.064			
20	0	1668	1645	1628	1615	1604	1596	1588	1582	1577	1572	0.802	1056	
	1	1748										0.394		
	2	1828	1783	1748	1722							0.261		
	3	1909	1852	1809	1775	1749	1727	1709						0.195
	4	1989	1920	1869	1829	1797	1771	1749	1731	1715	1701	0.156		
	5	2069	1989	1929	1883	1845	1815	1789	1768	1749	1733	0.130		
	6	2150	2058	1989	1936	1893	1858	1829	1805	1784	1765	0.111		
	7	2230	2127	2050	1990	1942	1902	1869	1842	1818	1797	0.097		
	8	2310	2196	2110	2043	1990	1946	1910	1819	1852	1829	0.086		
	9	2391	2265	2170	2097	2038	1990	1950	1916	1887	1862	0.078		
10	2471	2333	2230	2150	2086	2034	1990	1993	1921	1894	0.071			
18	0	1715	1686	1663	1646	1633	1621	1612	1604	1597	1591	0.923	1398	
	1	1819										0.454		
	2	1923	1864	1820	1785							0.301		
	3	2028	1854	1898	1855	1830	1792	1768						0.225
	4	2132	2043	1976	1924	1883	1849	1820	1797	1776	1758	0.180		
	5	2236	2132	2054	1994	1945	1906	1873	1845	1821	1800	0.150		
	6	2340	2222	2133	2063	2008	1963	1925	1893	1865	1842	0.128		
	7	2445	2311	2211	2133	2070	2019	1977	1941	1910	1883	0.112		
	8	2549	2400	2289	2202	2133	2076	2029	1989	1955	1925	0.099		
	9	2653	2490	2367	2272	2196	2133	2081	2037	1999	1967	0.090		
10	2757	2579	2445	2341	2258	2190	2133	2085	2044	2008	0.081			
16	0	1763	1727	1700	1678	1662	1648	1636	1626	1618	1611	1.037	1764	
	1	1892										0.510		
	2	2021	1948	1893	1850							0.338		
	3	2149	2058	1989	1936	1893	1858	1829						0.253
	4	2278	2168	2086	2022	1970	1928	1894	1864	1839	1817	0.202		
	5	2407	2278	2182	2107	2048	1999	1958	1923	1894	1868	0.168		
	6	2535	2389	2279	2193	2125	2069	2022	1983	1949	1920	0.144		
	7	2664	2499	2375	2279	2202	2139	2087	2042	2004	1971	0.126		
	8	2793	2609	2472	2365	2279	2209	2151	2102	2059	2023	0.112		
	9	2921	2720	2568	2451	2357	2279	2215	2161	2114	2074	0.101		
10	3050	2830	2665	2536	2434	2350	2280	2220	2170	2125	0.091			

K3 = 2380

¹ In conditions where the specified SIDELAP FASTENER spacing exceeds, 36 inches, sidelaps shall be attached with button-punches, screws, welds or VSC2's at a maximum spacing of 36 inches.

$$G' = \frac{K2}{3.5 + 3 * K1 * \text{Span}} + K3, \text{ kips/in}$$

NOTE: Span is in feet



DIAPHRAGM

1.5, 2 & 3 COMPOSITE DECK with LIGHT WEIGHT CONCRETE

- Support Fasteners: 5/8" Puddle Welds
- Sidelap Fasteners: Welded¹

$$\gamma_{conc} = 110 \text{ pcf}$$

$$f_c = 3000 \text{ psi}$$

$$t_{min} = 2.5" \text{ (min.)}$$

Factor of Safety = 3.25

36/4 Attachment Pattern

Deck Gage	# of Sidelap Fasteners	Allowable Diaphragm Shear Strength (plf)										K1	K2
		Span Length (ft-in.)											
		6'-0"	7'-0"	8'-0"	9'-0"	10'-0"	11'-0"	12'-0"	13'-0"	14'-0"	15'-0"		
22	0	1129	1110	1096	1085	1076	1069	1063	1058	1054	1050	0.728	870
	1	1196										0.358	
	2	1263	1225	1197	1174							0.237	
	3	1330	1282	1247	1219	1197	1179	1163				0.177	
	4	1397	1340	1297	1264	1237	1215	1197	1182	1168	1157	0.142	
	5	1464	1397	1347	1308	1277	1252	1230	1212	1197	1184	0.118	
	6	1531	1454	1397	1353	1317	1288	1264	1243	1226	1210	0.101	
	7	1597	1512	1447	1397	1357	1325	1297	1274	1254	1237	0.088	
	8	1664	1569	1498	1442	1397	1361	1331	1305	1283	1264	0.078	
	9	1731	1626	1548	1487	1438	1398	1364	1336	1312	1291	0.071	
	10	1798	1684	1598	1531	1478	1434	1398	1367	1340	1317	0.064	
20	0	1156	1133	1116	1103	1092	1084	1076	1070	1065	1061	0.802	1056
	1	1236										0.394	
	2	1316	1271	1237	1210							0.261	
	3	1397	1340	1297	1263	1237	1215	1197				0.195	
	4	1477	1408	1357	1317	1285	1259	1237	1219	1203	1189	0.156	
	5	1557	1477	1417	1371	1333	1303	1277	1256	1237	1221	0.130	
	6	1638	1546	1477	1424	1381	1346	1317	1293	1272	1253	0.111	
	7	1718	1615	1538	1478	1430	1390	1358	1330	1306	1285	0.097	
	8	1798	1684	1598	1531	1478	1434	1398	1367	1340	1318	0.086	
	9	1879	1753	1658	1585	1526	1478	1438	1404	1375	1350	0.078	
	10	1959	1822	1718	1638	1574	1522	1478	1441	1409	1382	0.071	
18	0	1203	1174	1152	1134	1121	1109	1100	1092	1085	1079	0.923	1398
	1	1307										0.454	
	2	1412	1352	1308	1273							0.301	
	3	1516	1442	1386	1343	1308	1280	1256				0.225	
	4	1620	1531	1464	1412	1371	1337	1309	1285	1264	1246	0.180	
	5	1724	1620	1542	1482	1433	1394	1361	1333	1309	1288	0.150	
	6	1828	1710	1621	1551	1496	1451	1413	1381	1353	1330	0.128	
	7	1933	1799	1699	1621	1558	1507	1465	1429	1398	1371	0.112	
	8	2037	1888	1777	1690	1621	1564	1517	1477	1443	1413	0.099	
	9	2141	1978	1855	1760	1684	1621	1569	1525	1487	1455	0.090	
	10	2245	2067	1933	1829	1746	1678	1621	1573	1532	1496	0.081	
16	0	1251	1215	1188	1167	1150	1136	1124	1114	1106	1099	1.037	1764
	1	1380										0.510	
	2	1509	1436	1381	1338							0.338	
	3	1637	1546	1477	1424	1381	1346	1317				0.253	
	4	1766	1656	1574	1510	1458	1417	1382	1352	1327	1305	0.202	
	5	1895	1767	1670	1596	1536	1487	1446	1411	1382	1356	0.168	
	6	2023	1877	1767	1681	1613	1557	1510	1471	1437	1408	0.144	
	7	2152	1987	1863	1767	1690	1627	1575	1530	1492	1459	0.126	
	8	2281	2097	1960	1853	1767	1697	1639	1590	1547	1511	0.112	
	9	2410	2208	2056	1939	1845	1768	1703	1649	1602	1562	0.101	
	10	2538	2318	2153	2025	1922	1838	1768	1708	1658	1614	0.091	

K3 = 2380

¹ In conditions where the specified SIDELAP FASTENER spacing exceeds, 36 inches, sidelaps shall be attached with button-punches, screws, welds or VSC2's at a maximum spacing of 36 inches.

$$G' = \frac{K2}{3.5 + 3 * K1 * \text{Span}} + K3, \text{ kips/in}$$

NOTE: Span is in feet

VULCRAFT SALES CORPORATION OFFICES



ALBUQUERQUE, NM

P. 505.892.0707

F. 505.892.2727

ATLANTA, GA

P. 770.307.2111

F. 770.307.1800

BALTIMORE, MD

P. 410.998.0800

F. 410.998.0801

BIRMINGHAM, AL

P. 205.982.4394

F. 205.982.6885

BOARDMAN, OH

P. 330.726.8833

F. 330.726.0694

CENTERVILLE, UT

P. 801.292.0730

F. 801.621.0927

COLUMBIA, SC

P. 803.358.1300

F. 803.358.1313

DALLAS, TX

P. 214.340.1883

F. 214.340.5897

DENVER, CO

P. 303.757.6323

F. 303.757.6324

DES MOINES, IA

P. 515.270.2500

F. 515.270.8849

EDISON, NJ

P. 732.738.8188

F. 732.738.9288

GENEVA, NY

P. 315.828.1730

F. 315.828.1740

GERMANTOWN, WI

P. 262.251.5666

F. 262.251.7065

GRAND RAPIDS, MI

P. 616.949.2106

F. 616.949.6694

HINSDALE, IL

P. 630.887.1400

F. 630.887.1477

HOUSTON, TX

P. 281.251.8857

F. 281.251.9515

INDIANAPOLIS, IN

P. 317.576.5399

F. 317.576.5395

KERNSVILLE, NC

P. 336.497.5302

F. 339.497.5307

KNOXVILLE, TN

P. 865.690.6388

F. 865.690.6389

LEXINGTON, KY

P. 859.271.2591

F. 859.271.2580

LITTLE ROCK, AR

P. 501.758.6424

F. 501.758.6427

MINNEAPOLIS, MN

P. 763.425.4399

F. 763.425.6905

NASHVILLE, TN

P. 615.871.9385

F. 615.871.9252

NEW HUDSON, MI

P. 248.486.6166

F. 248.486.6169

NORRISTOWN, PA

P. 610.539.6516

F. 610.539.6970

OGDEN, UT

P. 801.292.0730

F. 801.621.0927

OKLAHOMA CITY, OK

P. 405.715.2844

F. 405.715.5855

ORANGE, CA

P. 714.957.5713

F. 602.353.2229

OVERLAND PARK, KS

P. 913.341.9299

F. 913.341.5764

PHOENIX, AZ

P. 623.385.1649

F. 623.385.1660

RICHMOND, VA

P. 804.379.3704

F. 804.379.3709

SACRAMENTO, CA

P. 916.488.8180

F. 916.488.8099

SALEM, NH

P. 603.894.1146

F. 603.894.1149

SAN ANTONIO, TX

P. 210.655.9070

F. 210.655.9504

SEATTLE, WA

P. 425.402.9011

F. 425.482.6433

SPRINGFIELD, OH

P. 937.390.2300

F. 937.390.2333



Better Partners. Better Products.
Better Outcomes.